



**SIMPLIFY
YOUR
WORK
FLOW**

**PRODUCT CATALOGUE
2024**



Dear customers and partners of ORGATEX®,

What you are holding in your hands is more than just a catalogue. It is a departure.

More than ever, we are convinced that lean management and, above all, the efficient use of all resources – be it money, raw materials or employees – is the way forward for companies in the 21st century in order to be successful in the long term.

And more than ever, we are looking forward to making efficient processes easier to implement. **„Simplify your workflow“**, our new slogan, puts it in a nutshell.

And new is right on cue because we have several things that are new this year.

Our new image is certainly the most prominent novelty. New logo, new design, new campaign – we have completely updated our brand to demonstrate our passion for more efficient processes even more clearly.

As of page 14, we present our new products, for example the particularly robust LongLife outdoor floor marking tape, which you can use to create durable floor markings in outdoor areas.

We are especially proud of our new, digital eOX products such as the eOX-Button, which you can use in combination with the eOX-Cloud to automate intralogistics processes at the touch of a button. And thanks to narrowband mobile technology it is completely wireless.

We would particularly like to recommend our new online shop. At orgatex.com you will find everything you can find in the catalogue – easier and more convenient than ever before.

Despite everything that is new, you can rely on some things that remain the same: the quality and durability of our products, committed consultation and service and individualised solutions that work for you.

We hope you enjoy our new catalogue. We are confident that you will find the right solutions for your lean processes in our catalogue. And if you have any questions or suggestions, please do not hesitate to contact us.

Best regards

Your ORGATEX® Team

CONTENTENTS



VISUAL LEAN MANAGEMENT

CONTAINER LABELLING

Visual pockets, document holders, pallet clamp, sleeve for integrated card pockets

SHELF LABELLING

Label holders (transparent), label holders (coloured), magnetic labels/strips (coloured), individual shelf labelling

FLOOR MARKING

Floor marking tape, symbols/blanks, floor windows/transparent, set of parking space markings, floor labelling/eOX-Spot, heavy duty, modules, cold performance, accessories

INSERTION SYSTEMS

KANBAN starter sets, systembox, cardplan, KANBAN letterbox, Primus view box, work document sleeve

HANGING SIGNS

Hanging signs, hanging signs accessories, 5S suspension, aluminium snap frames

VISUAL BOARDS

Printed boards, wall boards, stand-alone boards, cubes, stop-sign, visual boards, accessories

DOCUMENT HOLDERS

Magnetic windows, Multi Windows, Clipboard, FLIP-MAG

ELECTROSTATIC DISCHARGE

Viewing pockets, receipt holders, document holders, insertion systems, floor marking, LongLife floor marking tape ESD, dollies ESD

MATERIAL FLOW

MATERIAL TRANSPORT

Dollies, shelfwagon, taxiwagon, adapter pallet

MATERIAL SUPPLY

Supermarkets/FIFO-Stations, parking slots, KLT lifts, workstation systems

SAFETY

OCCUPATIONAL SAFETY

Anti-slip tape, stair nosing profiles, photoluminescent markings, Safety and information signs, floor markings, zebra crossings, warning markings

NEW!

DIGITAL INTRALOGISTICS

THE EOX SERIES

eOX-Mobile Shopfloor Board, eOX-Label, eOX-Button, eOX-Energy-Control, eOX-Spot, eOX-Station, eOX-Monomover

NEW!

SERVICES

OUR RANGE OF SERVICES

On-site installations, on-site product consulting, seminars, Lean Factory

NEW!



WHY WE DO WHAT WE DO

WE LOVE LEAN! THAT'S WHY WE WANT TO SHARE IT.

Making efficiency simple is not just our business – it's our passion. We develop solutions, that help people to achieve more with less effort. You can see our passion in our products and feel it in the results.

WE ARE ORGATEX, SO THAT EVERYONE CAN BE EFFICIENT.

We want to help every company become a lean business. Because we are convinced that handling all resources with respect – from capital, raw materials, and materials to every single person – is the best way to deal with the economic and ecological challenges of our time. That is what we stand for. That what we work for with all our energy.

THERE IS ONLY ONE WAY TO LEAN BUSINESS: YOUR WAY.

We know from our many years of experience: Every company is special. With its different employees, needs and requirements. This is precisely why one-size-fits-all approaches are not effective. And this is precisely why we develop our solutions so that customised and scalable lean processes are possible for companies of all sizes.

IF IT'S NOT EASY, IT'S NOT LEAN!

It is not until all people in all companies can implement lean processes that every company can become lean. That is why it is worth making efficient processes easy to use for everyone. We will always be at your side during this important step towards a lean business. We promise.

SIMPLIFY YOUR WORKFLOW.

Are you interested? On the following pages, we will show you how you can make lean processes applicable using ORGATEX®.

VISUAL LEAN MANAGEMENT

LEAN AT FIRST GLANCE

30%
less
Costs

60%
less capital
commitment

70%
more
productivity

Perfect lean processes can be a real boost for your company.
But only if everyone is able to implement them.



Everything is clearly visible so that everything can be done quickly.

It is well known in process management to put at least as much love into the applicability of processes as into their design. Because the easier it is to understand and apply processes, the better the results will be. That's why we have been working so hard for 50 years to make efficient processes even easier for everyone to implement. Our way to achieve this: Visual Lean Management.

Using effective visual tools we help make processes visible and easy to use throughout the company.

For example, with extremely robust and always clearly visible floor markings that indicate paths or make storage areas clearly recognisable. With easily recognisable, clear markings, e.g. for materials or tools. And with easy-to-understand organisational aids such as the Cardplan insertion system or the KANBAN-boards.



To make it lean: all important information at a glance.



EFFICIENT MATERIAL FLOW

IT ONLY RUNS SMOOTHLY WHEN EVERYTHING FLOWS



Better
quality

Lower
storage costs

More
sustainability

you have the material flow under control, you have taken the decisive step towards the many advantages of optimised intralogistics.

We are happy to help.



Ensures lower storage costs, less material waste, higher speed – our FiFo railway station.

The right material in the right quantity in the right place at the right time – that is lean intralogistics. However, what sounds so simple is often much more complicated in practice. How do you ensure that there is always enough material available without ordering and paying for too much? And how can heavy materials be delivered to the right place without putting too much strain on the employees?

simple. Like our transport trolleys, which can be used to transport a lot of material. Or our powerful box lifting devices, which get production materials where they belong: to a working height. And last but not least, our ingenious FiFo stations, which put a smart (and, if required, digital) end to material wastage.

For decades, we have been searching and finding solutions for material to flow through the lifelines of companies so efficiently that can they grow and remain healthy. And since we are ORGATEX®, these solutions are not complicated, but



Material can be moved easily and efficiently with our transport trolleys.

SECURITY

IN SECURITY

Employee protection

Production stops prevention

Cost reduction

Lean strategy cannot work without security.
That is why we also provide support in this area
with solutions that make a big difference.



Safety regulations must be visible and understandable for everyone, especially in the hectic day-to-day operations.

Safety is a top priority in lean management. Because smart processes, simple tools, perfect intralogistics are unfortunately worthless if there is a lack of safety. Every accident interferes with or stops the production process. Every employee who is absent reduces productivity or must be replaced by costly external labour.

To avoid this simply but effectively, we have a large selection of safety products, such as anti-slip adhesive tape, mandatory action and information signs or clearly visible path markings. We pay particular attention to the robustness and durability of all our safety products. Because there is one thing safety must never do: lessen.



Our special tape ensures firm footing even in difficult places.



NEW PRO- DUCTS

New technologies and innovative solutions are revolutionising the way companies optimise their internal processes. The innovations from the ORGATEX® product world help to increase efficiency, reduce costs, further improve storage, and transport processes and make your company more secure. From digital mobile boards to eOX-Spots – these innovations will shape the future of intralogistics.



NEW PRODUCTS



PALLET CLAMP

LABELLING OF EURO PALLETS MADE EASY

The pallet clamp is robust, flexible and makes it easy to label every block on the pallet. With 3 slide-in compartments for receipts, you can keep an overview from any position.

[More information on page 53](#)



LOGLIFE FLOOR MARKING TAPE GRIP

ANTI-SLIP TAPE FOR ALL AREAS

Floor markings visualise danger zones ... but LongLifeGrip can do even more. With its particularly high adhesive strength and slip resistance (slip class R11), you will always be taking a safe step forward.

[More information on page 106](#)

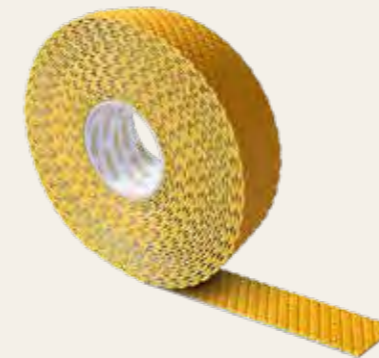

LOGLIFE FLOOR MARKING TAPE OUTDOOR

THE BEST FOR OUTDOORS

The high material thickness and the special synthetic rubber adhesive, in combination with our primer, ensure resistance under demanding outdoor conditions. Rough and uneven surfaces are no longer a problem thanks to the particularly strong adhesive. Even when wet, the reflective surface remains non-slip and clearly visible.

[More information on page 108](#)



LOGLIFE FLOOR MARKING TAPE HEAVY DUTY

STRONG HOLD FOR HIGH LOADS

The risk potential is highest on highly frequented routes. Robust and reliable markings are essential. Due to its particularly high material thickness, our LongLife Heavy Duty has the most resistant backing layer. The bevelled edges also make it resistant to forklift traffic.

[More information on page 107](#)

NEW PRODUCTS

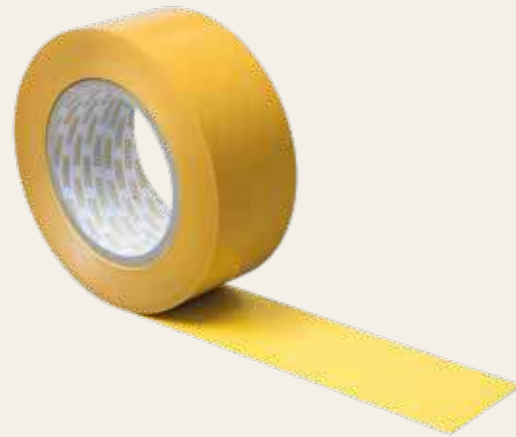

LONGLIFE FLOOR MARKING TAPE LOW DUTY

MARKING POTENTIAL DANGER ZONES

Unmarked danger zones are the most dangerous. Our LongLife Low Duty is easy to apply and can be removed just as quickly without leaving any residue so that dangerous areas can also be marked at short notice.

[More information on page 98](#)



SET FOR MARKING PARKING SPACES

REDUCE SEARCH TIMES, IMPROVE STRUCTURE

The marking of storage locations is crucial for structuring internal goods flows and warehousing. Avoid long search times and enable your employees to precisely allocate the materials to the according storage locations. We have put together the most important components in a set, combining our top sellers.

[More information on page 130](#)



VISUAL BOARDS

PRINTED BOARDS FOR YOUR SHOPFLOOR-MEETING

Discover our printed boards to efficiently organise and visualise your shop floor processes. You will also find useful accessories for structuring the boards in the document holders and insertion systems sections.

[More information on page 190](#)



WORKPLACE SYSTEMS

OPTIMISATION OF WORK PROCESSES AND RESOURCE UTILISATION

In today's business world, where precision and efficiency are crucial to a company's success, the optimal design of assembly workstations is of great importance.

[More information on page 298](#)

NEW PRODUCTS



eOX-CLOUD

THE DIGITISATION OF INTRALOGISTICS

The eOX-Cloud by ORGATEX® offers companies a secure and efficient way to manage, analyse and store eOX product data centrally. This allows you to increase your production processes and optimise efficiency.

[More information on page 344](#)



eOX-BUTTON

DIGITAL AT THE TOUCH OF A BUTTON

Optimise your operating processes by sending internal information at the touch of a button. No matter where the eOX-Button is used, it is immediately ready for use. Customisable messages increase the speed of replenishment and avoid delays. On the spacious e-paper display, you will receive immediate feedback.

[More information on page 350](#)



eOX-STATION

OPTIMISED PROCESSES FOR THE DIGITAL RAILWAY STATION

The eOX-Station is the digital extension to our classic FiFo station. Connect up to 120 lanes with an efficient pick-by-light system. False picks are reduced to a minimum, internal and external redelivery processes are automatically triggered according to the KANBAN principle and the digital interface enables direct access to all goods movements.

[More information on page 358](#)



eOX-SPOT

FOR ANY EVENTUALITY

With the eOX-Spot, oily, uneven, or rough floors are no longer a problem. Its strong High-power LED with the highly efficient luminous flux (4730 lm) casts the right sign in the right place – without any risk of tripping or wear out. The labelling can be quickly replaced at any time and adapted to current requirements.

[More information on page 354](#)

NEW PRODUCTS



eOX-LABEL

DIGITAL LABELS ARE THIS SUSTAINABLE

Digital intralogistics not only saves time in production, but also protects the environment. Our e-labels connect via the mobile phone network NB-IoT (NarrowBand IoT) and are therefore independent of any other infrastructure.

The e-paper displays combine the advantages of analogue media, such as scanability and legibility from all angles, with those of digital media, such as fast content exchange and reduced effort with minimal energy consumption.

[More information on page 348](#)



eOX MOBILE SHOPFLOOR BOARD

DIGITAL SHOPFLOOR MANAGEMENT

Bring all data from the cloud directly to your shop floor in real time. Industry 4.0 means collecting and analysing data and then evaluating it directly. Combine our mobile shopfloor solution with our digital products – so you are always up to date.

[More information on page 346](#)



eOX-MONOMOVER

A PUSH FOR PRODUCTION

The feed unit is the centrepiece of modern intralogistics: the eOX-Monomover transports floor rollers from A to B automatically with the help of its bristle belts. This way, FiFo stations can be upgraded and production processes are optimised. Light barriers at the end of each unit independently control the transport from one module to the next.

[More information on page 279](#)

ALSO NEW!



SECURITY FOR YOUR WORK PROCESSES

[More information on page 302](#)



OUR SERVICE OFFERS

[More information on page 362](#)



CONTAINER LABELLING

The basic requirement for efficient processes in operations: clear and distinct labelling of all containers. Whether it is a Eurobox, a plastic crate, a pallet cage, KLT, GLT or other containers: ORGATEX® always offers the right solution.



Visual pockets	From 26
Visual pockets for attaching	28
Mounting options for visual pockets	30
Visual pockets, self-adhesive	34
Visual pockets, magnetic	38
Visual pockets, super magnetic	42
Document holders	From 44
KANBAN cover, magnetic/self-adhesive	46
KANBAN cover for overhanging	47
Document holder KAN-COPA	48
KANBAN cover MEGA	49
Label cover, self-adhesive	50
Document holder KAN-CLIP	51
Label holder, self-adhesive	52
Pallet clamp	53
Pallet clamp/label holder	53
Covers for integrated cars pockets	From 54
KANBAN sleeves KLT-SNAPPER	54
KANBAN sleeves KAN label	55
KANBAN sleeves KLMU	56
KANBAN sleeves KNTA	57
Label holder for insertion	58
LongLife fabric tape dots	59



[katalog.orgatex.com/
behalterkennzeichnung](https://katalog.orgatex.com/behalterkennzeichnung)

There are numerous variants of container shapes and materials: some common containers already have inserts that can be used for labelling, e.g. KLT containers or Euroboxes. We offer customised label holders and card pockets in a wide variety of designs for this purpose. However, our solutions also provide a remedy for the numerous container variants without existing inserts: if, for example, there are no suitable surfaces for attaching labels, our high-quality, processed visual pockets are the perfect solution.

We offer a wide variety of options for attaching the visual pockets, so they can be applied to virtually any surface.

If your containers are made of metal, our magnetic pockets or our magnetic document holders can be utilised. Plastic, wooden or glass containers can be perfectly and securely labelled with our self-adhesive visual pockets. Regardless of which container variants you use, you will always find the right solution for convenient, efficient, and clear labelling.



INFOGRAPHIC VISUAL POCKETS

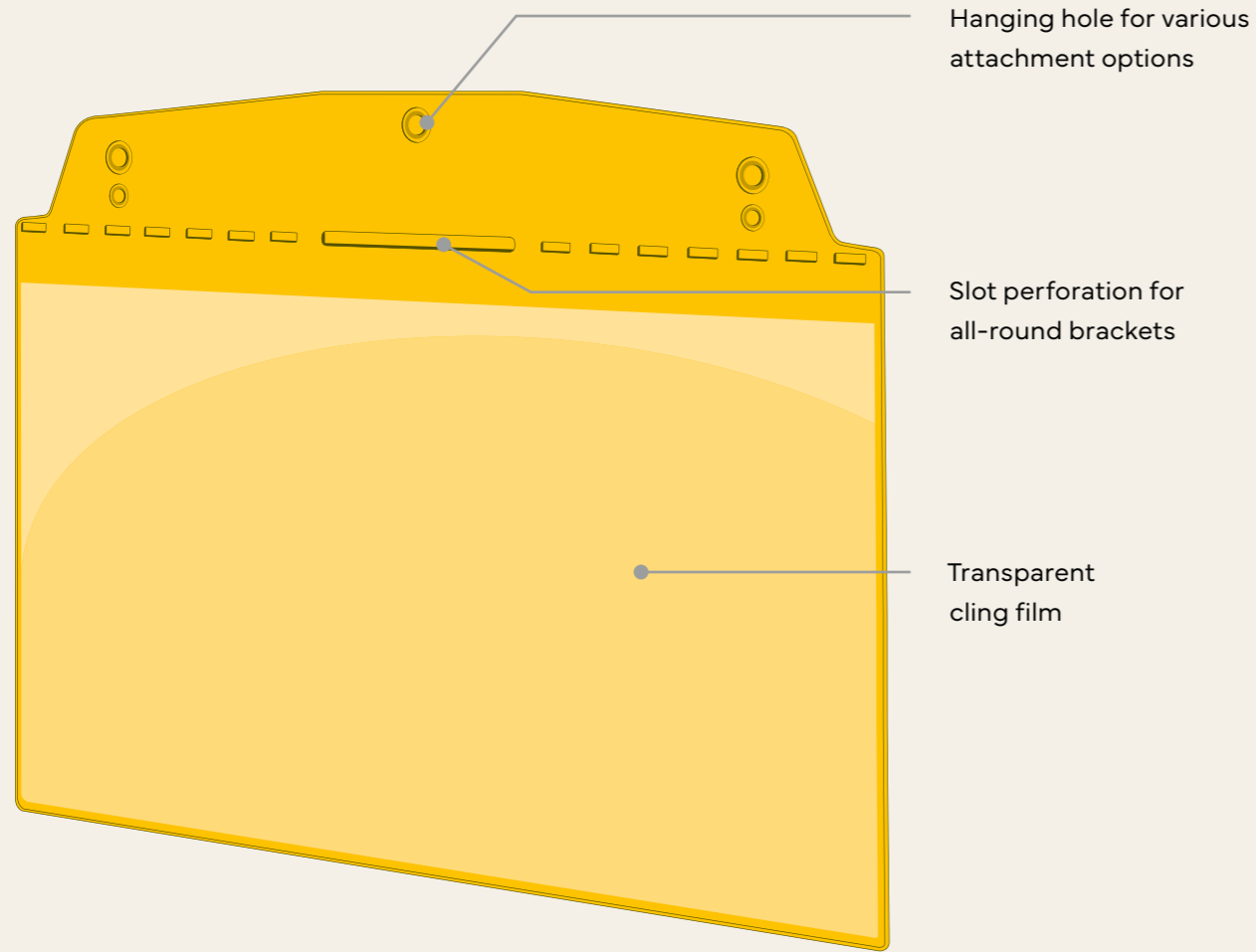

Suitable for all containers



For flexible or permanent labelling



Wide range of mounting options

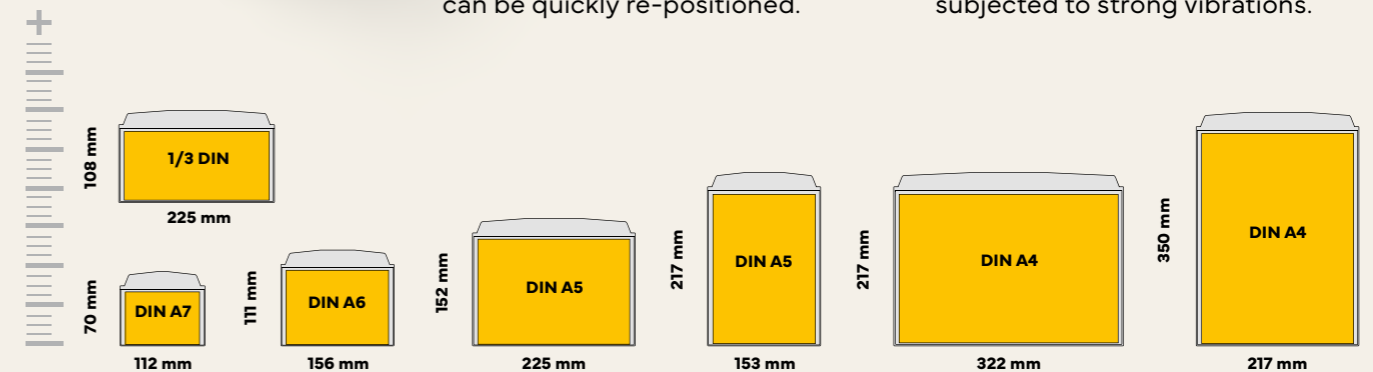
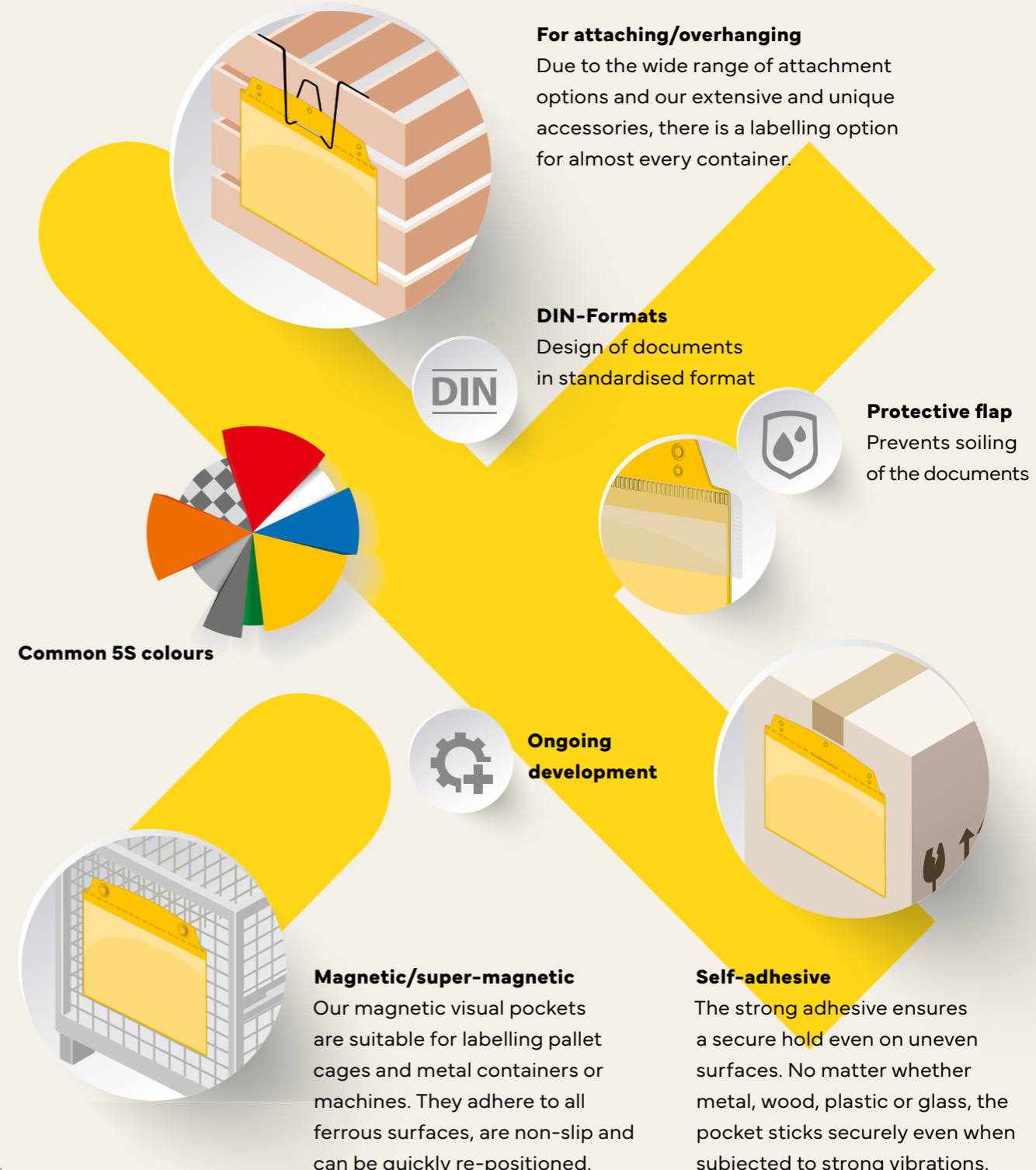



VISUAL POCKETS FOR ATTACHING



In many cases, there are no suitable surfaces on containers for attaching labelling. This can be remedied with the clip-on visual pockets. Thanks to the wide range of attachment options and our extensive and unique accessories, there are labelling options for almost any surface.

- 5 hanging holes
- Also available with protective flap

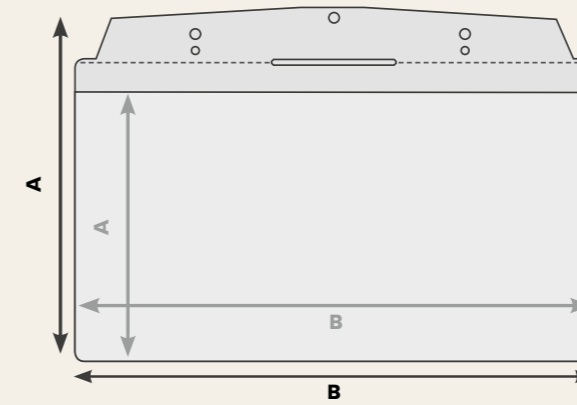

Available formats in mm, outer dimension / inner dimension

	1/3	A7 landsc.	A6 landsc.	A5 landsc.	A5 portr.	A4 landsc.	A4 portr.
A	160/108	112/70	159/111	205/152	264/217	268/217	350/322
B	230/225	115/112	159/156	230/225	160/153	325/322	229/217





VISUAL POCKETS FOR ATTACHING, MOUNTING OPTIONS FOR VISUAL POCKETS



Standard version

Format	Order no.	+ Colour code	Pack
DIN A7 landsc.	SD011-	01 02 03 04 05 06 07 08 20	10 pcs.
DIN A6 landsc.	SD012-	01 02 03 04 05 06 07 08 20	10 pcs.
1/3 DIN	SD016-	01 02 03 04 05 06 07 08 20	10 pcs.
DIN A5 landsc.	SD013-	01 02 03 04 05 06 07 08 20	10 pcs.
DIN A5 portr.	SD015-	01 02 03 04 05 06 07 08 20	10 pcs.
DIN A4 portr.	SD018-	01 02 03 04 05 06 07 08 20	10 pcs.
DIN A4 landsc.	SD020-	01 02 03 04 05 06 07 08 20	10 pcs.



With protective flap

Format	Order no.	+ colour code	Pack
DIN A5 landsc.	SD014-	01 02 03 04 05 06 07 08 20	10 pcs.
DIN A4 portr.	SD019-	01 02 03 04 05 06 07 08 20	10 pcs.
DIN A4 landsc.	SD021-	01 02 03 04 05 06 07 08 20	10 pcs.

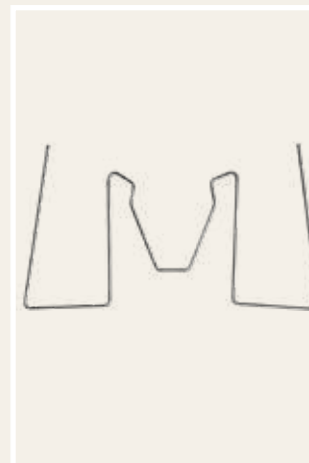

All-round bracket (patented)

Order no.	Pack
KTB3000	10 pcs.

The patented all-round bracket for quick attachment to our pockets with a slot perforation in the upper section. Designed for pallet cages and/or thick-walled containers up to 4 cm. Dimensions (W x H): 215 x 125 mm.

The all-round bar **cannot be used** with:

- Pocket design with protective flap
- DIN A7, DIN A4 landscape

Wall bracket for hangers

Order no.	Pack
WDH1	5 pcs.

Pockets that are not currently in use can be conveniently „parked“ on the wall holder to save space. Suitable for special support bracket MA2000 and all-round bracket KTB3000. Dimensions (W x H x D): 210 x 25 x 60 mm.

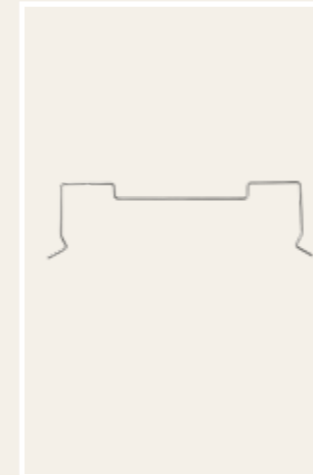
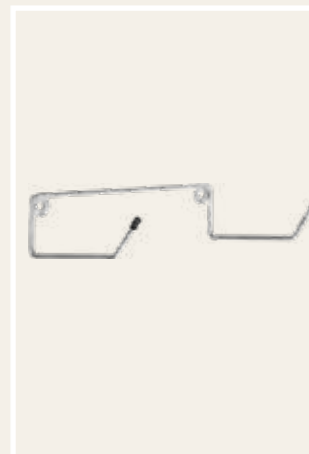

Special retaining bracket

Order no.	Pack
MA2000	10 pcs.

Made of black coated spring steel wire with rounded ends. The special retaining bracket is pulled through the two outer suspension holes of the visual pockets.

Due to the spring steel design, it sits firmly between bars or cardboard boxes, on lattice boxes, etc. This bracket can be hung, inserted and attached in between by turning.

Dimensions (WxH): 320 x 100 mm. Particularly suitable for DIN A4 landscape, cannot be used for DIN A6 landscape and DIN A5 portrait.

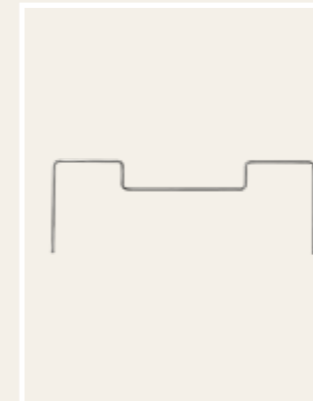

Mini special retaining bracket

Order no.	Pack
MA2080	10 pcs.

The mini special retaining bracket made of spring steel wire was developed for attaching smaller pocket formats (DIN A6 landscape, DIN A5 portrait). Secure hold on cardboard boxes, containers, mesh boxes etc. This bracket can be hung, inserted, and attached in between by turning.

Dimensions (WxH): 230 x 80 mm.

Only suitable for DIN A6 landscape and DIN A5 portrait.

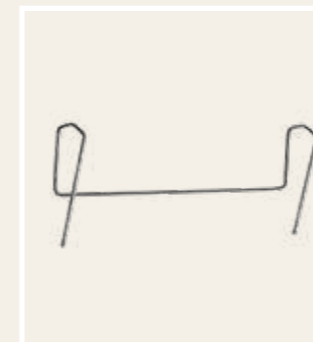

Container bracket

Order no.	Pack
MA2090	10 pcs.

Made of black-coated spring steel wire with rounded ends.

This flexible attachment is particularly recommended for thick-walled containers **up to approx. 2 cm thick**.

Dimensions (WxHxD): 170 x 65 x 21 mm.

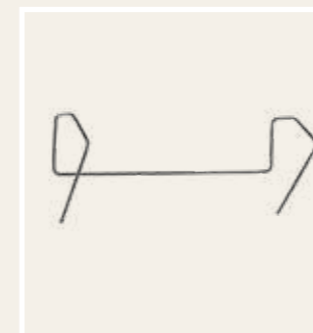

Container bracket

Order no.	Pack
MA2100	10 pcs.

Made of black-coated spring steel wire with rounded ends.

This flexible attachment is particularly recommended for thick-walled containers **up to approx. 5 cm thick**.

Dimensions (WxHxD): 170 x 65 x 45 mm.



MOUNTING OPTIONS FOR VISUAL POCKETS



U-clamps (patented)

Order no.	Pack
MA2030	50 pcs.

For attaching pockets/sleeves to all types of pallet cages. The special bending enables easy removal. Dimensions (WxH): 28 x 55 mm.

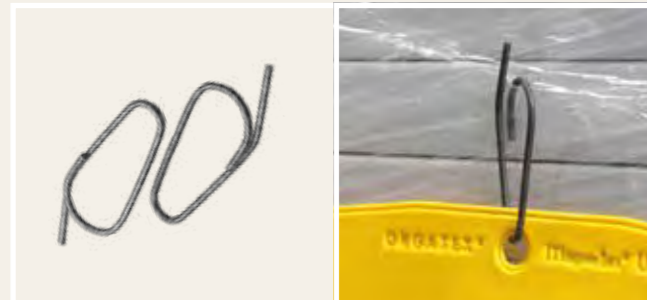

U-clamps

Order no.	Pack
MA2020	50 pcs.

For piercing cardboard, film and other outer packaging and when using small pocket sizes (DIN A7/DIN A6). Dimensions (WxH): 15 x 38 mm.



Steel clips

Order no.	Pack
MA2070	10 pcs.

For clamping the pockets to plastic crates, bars, wooden slats, cardboard boxes, etc. Quick to change. Spread width 17 mm, non-slip rubber shoes on the grippers for a gentle grip. Length: 35 mm.



Plastic spike

Order no.	Pack
MA2060	50 pcs.

For piercing soft materials such as cardboard, film, plastic bags, textiles, etc. Length: 12 mm.



KAN-Gripper

Order no.	Pack
KAN-Gripper	100 pcs.

For hanging on pallet cages, the pocket is clamped in the holder.



KAN-U-Gripper

Order no.	Pack
KAN-U-Gripper	100 pcs.

For overhanging, e.g. on pallet cages, with 2 parallel hooks and wide pocket clip.



Plastic tie

Order no.	Pack
MA2050	50 pcs.

Plastic ties are highly recommended if the pockets are to be permanently attached or, for example, attached to profiles, cables or the like. The special fastener allows for multiple use. Length: 320 mm.



Hook-and-loop dot

Order no.	Set
PFH22	100 pair

Hook-and-loop dot (Ø 22 mm) with high adhesive force for detachable connections. Easy fixing of a wide variety of materials. Set = 100 fleece dots and 100 hook dots.



Metal tape, self-adhesive

Order no.	Rolle
BMS35	5 m

The self-adhesive metal tape with strong adhesive force is particularly suitable for making non-metallic materials magnetic. Any unevenness on the surface is levelled out by the foam adhesive applied to the back. The white surface offers a particularly neutral appearance. The product can be processed from the roll (35 x 5000 mm) and cut directly to size with scissors.



VST-Gripper

Order no.	Pack
VST-GRIPPER	50 pcs.

The round tube label holder makes it easy to flexibly attach visual pockets or label holders to round tubes with a diameter of 28 to 30 mm. The grip points on the inside prevent slipping when fitting or removing the labelling. The interlocked mount provides a secure hold even with vibration.





VISUAL POCKETS SELF-ADHESIVE



With strong foam adhesive strips on the back, all pocket types can be attached to suitable surfaces. Be it metal, wood, plastic, precious metal or glass: the pocket adheres securely even when subjected to strong vibrations or on uneven surfaces.

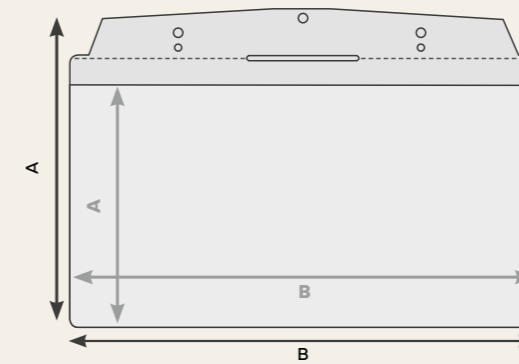

Available formats in mm, outer dimension / inner dimension

	1/3	A7 landsc.	A6 landsc.	A5 landsc.	A5 portr.	A4 landsc.	A4 portr.
A	160/108	112/70	159/111	205/152	264/217	268/217	350/322
B	230/225	115/112	159/156	230/225	160/153	325/322	229/217





VISUAL POCKETS SELF-ADHESIVE



With 1 foam adhesive strip

Format	Order no.	+ Colour code										Pack
		01	02	03	04	05	06	07	08	20		
DIN A7 landsc.	SDSK/7110-	01	02	03	04	05	06	07	08	20	10 pcs.	
DIN A6 landsc.	SDSK/6110-	01	02	03	04	05	06	07	08	20	10 pcs.	
1/3 DIN	SDSK/1310-	01	02	03	04	05	06	07	08	20	10 pcs.	
DIN A5 landsc.	SDSK/5110-	01	02	03	04	05	06	07	08	20	10 pcs.	
DIN A5 portr.	SDSK/5210-	01	02	03	04	05	06	07	08	20	10 pcs.	
DIN A4 portr.	SDSK/4210-	01	02	03	04	05	06	07	08	20	10 pcs.	
DIN A4 landsc.	SDSK/4110-	01	02	03	04	05	06	07	08	20	10 pcs.	



With 2 foam adhesive strips

Format	Order no.	+ Colour code										Pack
		01	02	03	04	05	06	07	08	20		
DIN A7 landsc.	2SDSK/7110-	01	02	03	04	05	06	07	08	20	10 pcs.	
DIN A6 landsc.	2SDSK/6110-	01	02	03	04	05	06	07	08	20	10 pcs.	
1/3 DIN	2SDSK/1310-	01	02	03	04	05	06	07	08	20	10 pcs.	
DIN A5 landsc.	2SDSK/5110-	01	02	03	04	05	06	07	08	20	10 pcs.	
DIN A5 portr.	2SDSK/5210-	01	02	03	04	05	06	07	08	20	10 pcs.	
DIN A4 portr.	2SDSK/4210-	01	02	03	04	05	06	07	08	20	10 pcs.	
DIN A4 landsc.	2SDSK/4110-	01	02	03	04	05	06	07	08	20	10 pcs.	

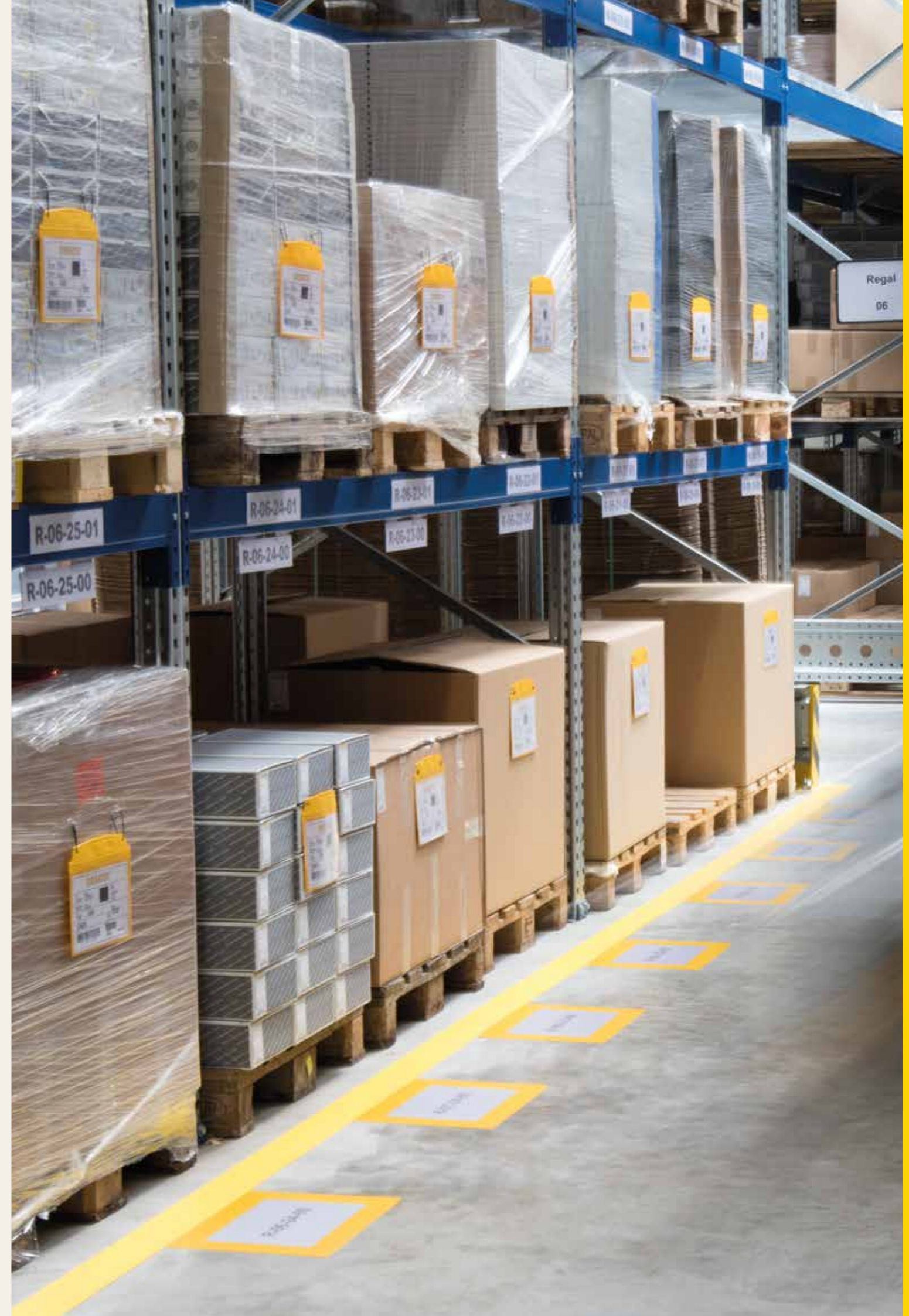



VISUAL POCKETS MAGNETIC



Magnetic pockets made of hard-wearing plastic with a reinforced upper section have a transparent front. Inserted papers can be read without removing them. The magnetic strips on the back feature high magnetic adhesive force and quality.

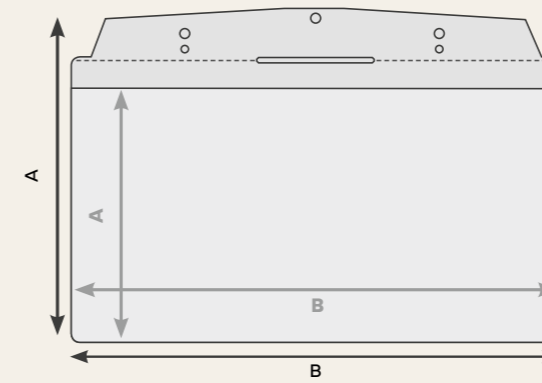

Available formats in mm, outer dimension / inner dimension							
	1/3	A7 landsc.	A6 landsc.	A5 landsc.	A5 portr.	A4 landsc.	A4 portr.
A	160/108	112/70	159/111	205/152	264/217	268/217	350/322
B	230/225	115/112	159/156	230/225	160/153	325/322	229/217





VISUAL POCKETS MAGNETIC



1 magnetic strip

Format	Order no.	+ Colour code										Pack
		01	02	03	04	05	06	07	08	20	20	
DIN A7 landsc.	MA7110-	01	02	03	04	05	06	07	08	20	20	10 pcs.
DIN A6 landsc.	MA6110-	01	02	03	04	05	06	07	08	20	20	10 pcs.
1/3 DIN	MA1310-	01	02	03	04	05	06	07	08	20	20	10 pcs.
DIN A5 landsc.	MA5110-	01	02	03	04	05	06	07	08	20	20	10 pcs.
DIN A5 portr.	MA5210-	01	02	03	04	05	06	07	08	20	20	10 pcs.
DIN A4 portr.	MA4210-	01	02	03	04	05	06	07	08	20	20	10 pcs.
DIN A4 landsc.	MA4110-	01	02	03	04	05	06	07	08	20	20	10 pcs.



2 magnetic strips

Format	Order no.	+ Colour code										Pack
		01	02	03	04	05	06	07	08	20	20	
DIN A7 landsc.	SD2M/7110-	01	02	03	04	05	06	07	08	20	20	10 pcs.
DIN A6 landsc.	SD2M/6110-	01	02	03	04	05	06	07	08	20	20	10 pcs.
1/3 DIN	SD2M/1310-	01	02	03	04	05	06	07	08	20	20	10 pcs.
DIN A5 landsc.	SD2M/5110-	01	02	03	04	05	06	07	08	20	20	10 pcs.
DIN A5 portr.	SD2M/5210-	01	02	03	04	05	06	07	08	20	20	10 pcs.
DIN A4 portr.	SD2M/4210-	01	02	03	04	05	06	07	08	20	20	10 pcs.
DIN A4 landsc.	SD2M/4110-	01	02	03	04	05	06	07	08	20	20	10 pcs.



4 magnetic strips

Format	Order no.	+ Colour code										Pack
		01	02	03	04	05	06	07	08	20	20	
DIN A5 landsc.	SD4M/5110-	01	02	03	04	05	06	07	08	20	20	10 pcs.
DIN A5 portr.	SD4M/5210-	01	02	03	04	05	06	07	08	20	20	10 pcs.
DIN A4 portr.	SD4M/4210-	01	02	03	04	05	06	07	08	20	20	10 pcs.
DIN A4 landsc.	SD4M/4110-	01	02	03	04	05	06	07	08	20	20	10 pcs.



Magnetic vinyl, all-over

Format	Order no.	+ Colour code										Pack
		01	02	03	04	05	06	07	08	20	20	
DIN A6 landsc.	SDVF/6110-	01	02	03	04	05	06	07	08	20	20	10 pcs.
1/3 DIN	SDVF/1310-	01	02	03	04	05	06	07	08	20	20	10 pcs.
DIN A5 landsc.	SDVF/5110-	01	02	03	04	05	06	07	08	20	20	10 pcs.
DIN A5 portr.	SDVF/5210-	01	02	03	04	05	06	07	08	20	20	10 pcs.
DIN A4 portr.	SDVF/4210-	01	02	03	04	05	06	07	08	20	20	10 pcs.
DIN A4 landsc.	SDVF/4110-	01	02	03	04	05	06	07	08	20	20	10 pcs.



1 magnetic strip (protective flap)

Format	Order no.	+ Colour code										Pack
		01	02	03	04	05	06	07	08	20	20	
DIN A5 landsc.	MA5111-	01	02	03	04	05	06	07	08	20	20	10 pcs.
DIN A4 portr.	MA4211-	01	02	03	04	05	06	07	08	20	20	10 pcs.
DIN A4 landsc.	MA4111-	01	02	03	04	05	06	07	08	20	20	10 pcs.



2 magnetic strips (protective flap)

Format	Order no.	+ Colour code										Pack
		01	02	03	04	05	06	07	08	20	20	
DIN A5 landsc.	SD2M/5111-	01	02	03	04	05	06	07	08	20	20	10 pcs.
DIN A4 portr.	SD2M/4211-	01	02	03	04	05	06	07	08	20	20	10 pcs.
DIN A4 landsc.	SD2M/4111-	01	02	03	04	05	06	07	08	20	20	10 pcs.



4 magnetic strips (protective flap)

Format	Order no.	+ Colour code										Pack
		01	02	03	04	05	06	07	08	20	20	
DIN A5 landsc.	SD4M/5111-	01	02	03	04	05	06	07	08	20	20	10 pcs.
DIN A4 portr.	SD4M/4211-	01	02	03	04	05	06	07	08	20	20	10 pcs.
DIN A4 landsc.	SD4M/4111-	01	02	03	04	05	06	07	08	20	20	10 pcs.



Magnetic vinyl, all-over (protective flap)

Format	Order no.	+ Colour code										Pack
		01	02	03	04	05	06	07	08	20	20	
DIN A5 landsc.	SDVF/5111-	01	02	03	04	05	06	07	08	20	20	10 pcs.
DIN A4 portr.	SDVF/4211-	01	02	03	04	05	06	07	08	20	20	10 pcs.
DIN A4 landsc.	SDVF/4111-	01	02	03	04	05	06	07	08	20	20	10 pcs.



VISUAL POCKETS SUPER-MAGNETIC



The super-magnetic visual pocket with 2 neodymium magnets has been specially developed for small ferrous surfaces (pallet cages) or curved or uneven surfaces (e.g. barrels). Guarantees a secure hold even with rough treatment (vibration, transport, etc.).

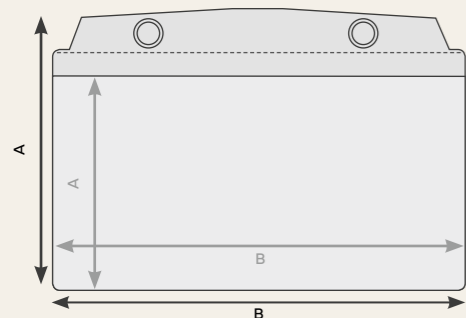

Available formats in mm, outer dimension / inner dimension

	A6 landsc.	A5 landsc.	A4 landsc.	A4 portr.
A	159/111	205/152	268/217	350/322
B	159/156	230/225	325/322	229/217



Neodymium magnets

Format	Order no.	+ Colour code								Pack	
		01	02	03	04	05	06	07	08		20
DIN A6 landsc.	MU2260-	01	02	03	04	05	06	07	08	20	10 pcs.
DIN A5 landsc.	MU2250-	01	02	03	04	05	06	07	08	20	10 pcs.
DIN A4 portr.	MU2240-	01	02	03	04	05	06	07	08	20	10 pcs.
DIN A4 landsc.	MU2230-	01	02	03	04	05	06	07	08	20	10 pcs.



Neodymium magnets and magnetic strips

Format	Order no.	+ Colour code								Pack	
		01	02	03	04	05	06	07	08		20
DIN A6 landsc.	MUV260-	01	02	03	04	05	06	07	08	20	10 pcs.
DIN A5 landsc.	MUV250-	01	02	03	04	05	06	07	08	20	10 pcs.
DIN A4 portr.	MUV240-	01	02	03	04	05	06	07	08	20	10 pcs.
DIN A4 landsc.	MUV230-	01	02	03	04	05	06	07	08	20	10 pcs.



Neodymium magnets (protective flap)

Format	Order no.	+ Colour code								Pack	
		-	-	-	-	-	-	07	-		-
DIN A5 landsc.	MU2251-	-	-	-	-	-	-	07	-	-	10 pcs.
DIN A4 portr.	MU2241-	-	-	-	-	-	-	07	-	-	10 pcs.
DIN A4 landsc.	MU2231-	-	-	-	-	-	-	07	-	-	10 pcs.



Neodymium magnets and magnetic strips (protective flap)

Format	Order no.	+ Colour code								Pack	
		-	-	-	-	-	-	07	-		-
DIN A5 landsc.	MUV251-	-	-	-	-	-	-	07	-	-	10 pcs.
DIN A4 portr.	MUV241-	-	-	-	-	-	-	07	-	-	10 pcs.
DIN A4 landsc.	MUV231-	-	-	-	-	-	-	07	-	-	10 pcs.





INFOGRAPHIC LABEL AND RECEIPT HOLDER

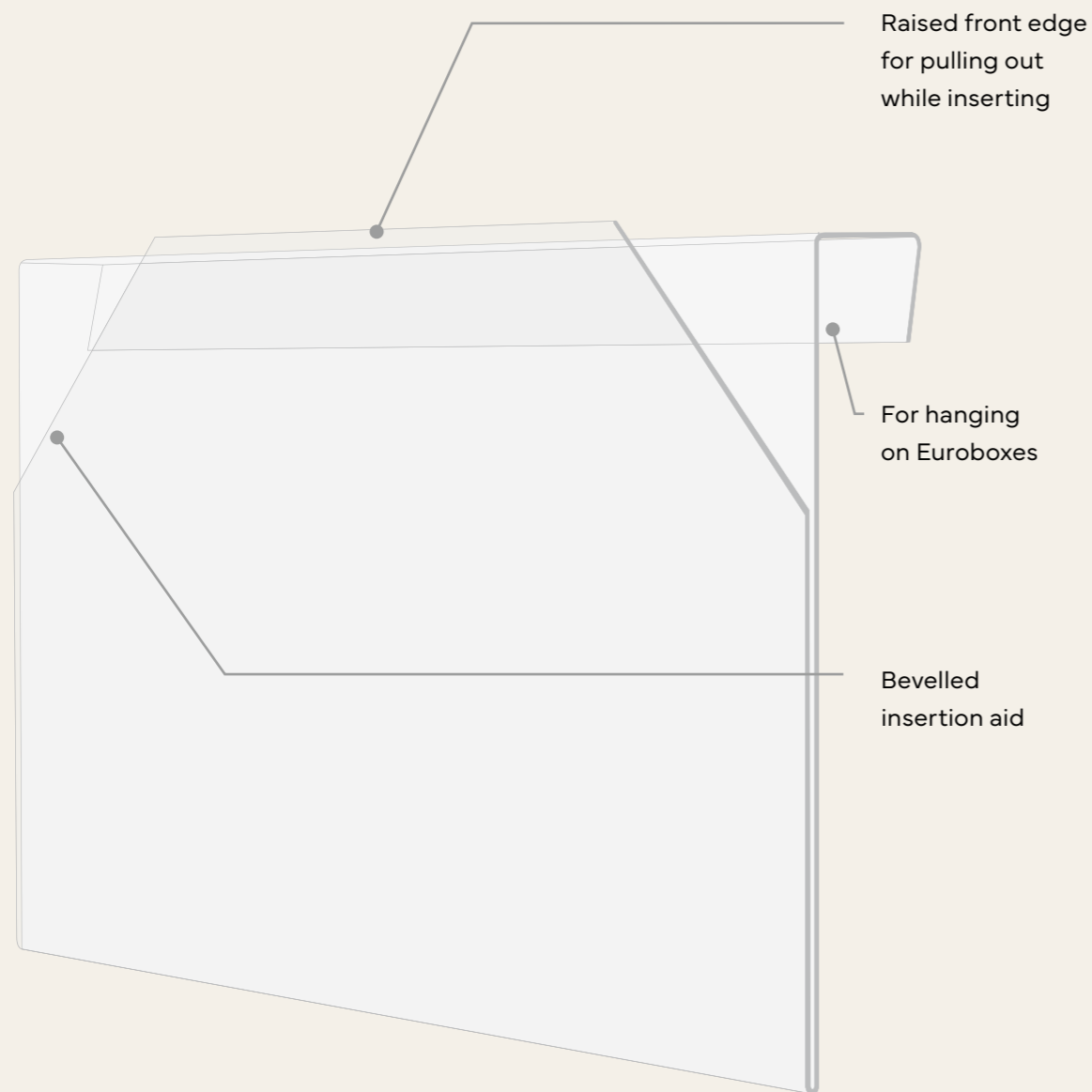

Suitable for all containers



For flexible or permanent labelling

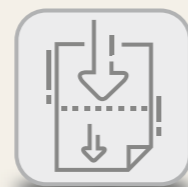

Pre-cut cardboard inserts for customised printing

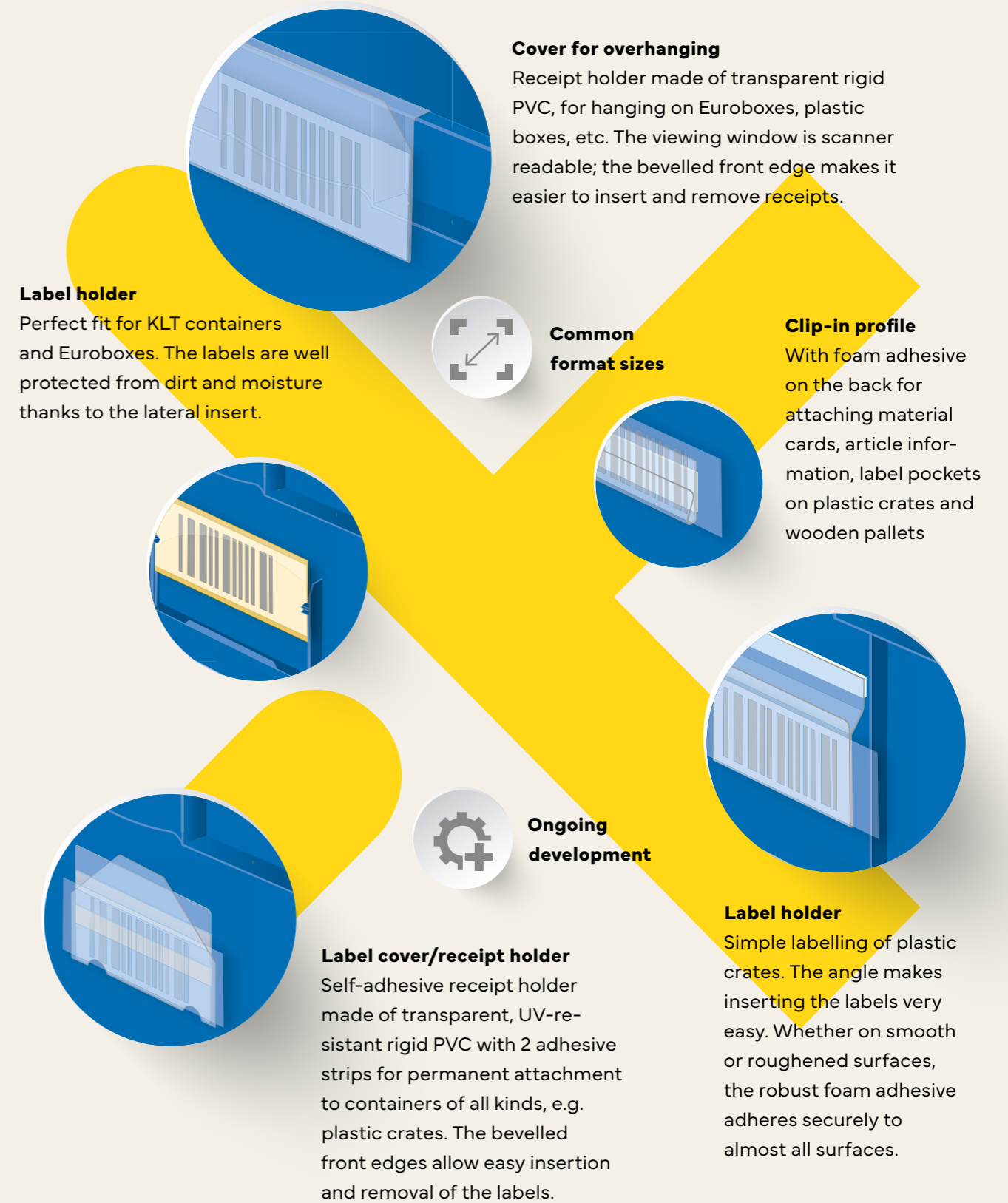



KANBAN-COVER MAGNETIC/SELF-ADHESIVE



Self-adhesive or magnetic receipt holder made of transparent rigid PVC for attaching to Euroboxes, plastic crates, metal containers, etc.

- Easy insertion and removal of slips due to bevelled front edge
- Scanner-readable and UV-resistant



KANBAN-Cover, magnetic/self-adhesive

Format	Order no.	Properties	Pack
DIN A7	KAN-COSA7	Self-adhesive	10 Pcs.
DIN A6	KAN-COSA6	Self-adhesive	10 Pcs.
DIN A5	KAN-COSA5	Self-adhesive	10 Pcs.
1/4 DIN (220 x 80 mm)	KAN-COS1/4DIN	Self-adhesive	10 Pcs.
EC (85 x 62 mm)	KAN-COS-EC	Self-adhesive	10 Pcs.
DIN A7	KAN-COMA7	Magnetic	10 Pcs.
DIN A6	KAN-COMA6	Magnetic	10 Pcs.
DIN A5	KAN-COMA5	Magnetic	10 Pcs.
1/4 DIN (220 x 80 mm)	KAN-COM1/4DIN	Magnetic	10 Pcs.
EC (85 x 62 mm)	KAN-COM-EC	Magnetic	10 Pcs.



KANBAN-COVER FOR OVERHANGING



Receipt holder made of transparent rigid PVC, for hanging over Euroboxes, plastic crates, etc. The viewing window is scanner readable, the bevelled front edge makes it easier to insert and remove receipts.

- Containers remain stackable
- UV-resistant
- Good clamping effect
- Good handling
- Scanner-readable QR code/barcode



KANBAN-Cover for overhanging

Format (WxHxD) (mm)	Order no.	Pack
215 x 80 x 17	KAN-COW1/4DIN	10 Pcs.
215 x 155 x 17	KAN-COWA5	10 Pcs.
155 x 110 x 17	KAN-COWA6	10 Pcs.
110 x 80 x 17	KAN-COWA7	10 Pcs.
87 x 55 x 17	KAN-COW-EC	10 Pcs.



DOCUMENT HOLDER KAN-COPA



Document holder made of transparent rigid PVC with a 90° angled insert tab. Especially suitable for labelling cardboard boxes or stacked products.

- Scanner-readable QR code/barcode
- UV-resistant
- Easy handling

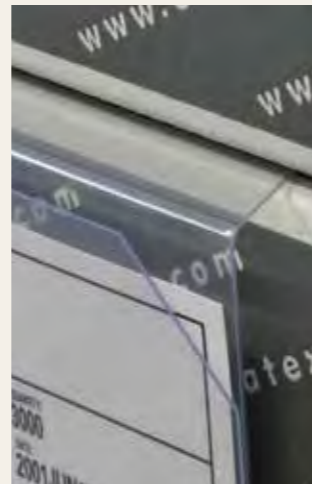

KAN-COPA document holder

Format (WxH) (mm)	Order no.	Pack
210 x 148	KAN-COPA5	10 Pcs.
148 x 105	KAN-COPA6	10 Pcs.
105 x 74	KAN-COPA7	10 Pcs.
220 x 80	KAN-COPI/4DIN	10 Pcs.



KANBAN-COVER MEGA



Secure labelling of loose materials such as bulk goods or C-parts using the KANBAN cover by placing it directly on the container. If there are no label holders on the container, the KANBAN card holder is the right solution due to its own weight. Can be used, for example, as checked/blocked labelling or as a carrier for KANBAN cards and can also be used in all ORGATEX® KANBAN or Heijunka boards.

- Matt material (no reflection)
- Extremely robust
- Scratch resistant
- Suitable for the ORGATEX® system box
- Good readability of receipts/KANBAN cards



KANBAN-Cover MEGA

Format (WxH) (mm)	Order no.	Pack
215 x 100	KAN-CO1/3DIN	10 Pcs.



LABEL-COVER SELF-ADHESIVE



With its 2 high-performance adhesive strips on the back, it is particularly suitable for containers with smooth walls. The raised front side makes it easier to insert/remove the receipts.

- Scanner-readable and UV-resistant



Label-Cover, self-adhesive

Format	Order no.	Properties	Pack
DIN A7	LABCOVA7-2	2 Adhesive strips, self-adhesive	10 Pcs.
DIN A6	LABCOVA6-2	2 Adhesive strips, self-adhesive	10 Pcs.
DIN A5	LABCOVA5-2	2 Adhesive strips, self-adhesive	10 Pcs.
1/4 DIN (220 x 80 mm)	LABC1/4-2	2 Adhesive strips, self-adhesive	10 Pcs.



DOCUMENT HOLDER KAN-CLIP



Clip-in profile with foam adhesive on the back for attaching material cards, article information and label pockets to plastic crates and wooden pallets. Whether on smooth or roughened plastic surfaces, aluminium, wood-like surfaces, glass and ceramic surfaces, precious or other fine metal surfaces or multicoated metal surfaces, the foam adhesive adheres securely to almost all surfaces.

- Simple labelling of boxes and containers
- Excellent labelling of pallet feet
- Self-adhesive on almost all surfaces



KAN-Clip document holder

Format (WxH) (mm)	Order no.	Pack
75 x 31	KAN-CLIP75	100 Pcs.



LABEL HOLDER SELF-ADHESIVE



Clip-in profile with foam adhesive on the back for attaching material cards, article information and label pockets to plastic crates. Made of transparent rigid PVC for insertion.

- Secure hold
- Dust-protected
- Scanner readable
- UV-resistant
- Easy handling
- Easy insertion and removal of receipts



Label holder, self-adhesive

Format (WxHxD) (mm)	Order no.	Pack
61 x 100 x 14	KAN-COSW100-60	100 Pcs.



PALLET CLAMP/LABEL HOLDER



Labelling Euro pallets easily

The pallet clamp is robust, flexible and makes it easy to label every block on the pallet. With 3 slide-in compartments for receipts, you can keep an overview from any position. The clamp is fixed to the respective block by utilising the pretension provided by the geometry of the clamp and the bars on the back. Regardless of the viewer's position, the document inserts on both long sides and on the closed short side make the labelling of the pallet visible.

- Even more stable and of higher quality than the previous model (injection moulding process)
- Now placement in the centre and on the corner blocks of the pallet is possible
- Signal colour yellow
- Other colours on request



Pallet clamp/Label holder

Designation	Order no.	Format (WxHxD) (mm)	Pack
Pallet clamp	KAN-PS2-04	160 x 117 x 72	20 Pcs.
Label holder, transparent	KAN-PS2-HE100	100 x 2,5 x 70	20 Pcs.
Label holder, transparent	KAN-PS2-HE150	150 x 2,5 x 70	20 Pcs.
Cardboard labels, white	ET600	100 x 67	80 Pcs.
Cardboard labels, white	ET650	150 x 67	40 Pcs.



KANBAN SLEEVES KLT-SNAPPER



Easy insertion, secure hold even under load.
Available in various colours.

- Cardboard inserts available in the suitable size
- Scanner readable
- VDA standard 4902



KLT-Snapper Kanban sleeves

Order no.	+ Colour code										Inner / Outer dim. (WxH) (mm)	Inlay	Pack
	1	2	3	4	5	6	8	88	20	20			
KLT-SNAP/	1	2	3	4	5	6	8	88	20	20	200 x 67/209 x 80	ET670	50 Pcs.
KLT-SNAP-1/3DIN/	1	2	3	4	5	6	8	88	20	20	200 x 85/209 x 99	ET85	50 Pcs.
KLT-SNAP-DINA5/	1	2	3	4	5	6	8	88	20	20	200 x 135/209 x 147	ET135	50 Pcs.

Cardboard inserts (Inlays) on page 83



KANBAN SLEEVES KAN-LABEL



KAN-Label is a particularly hard-wearing version of our labelling pockets. The cardboard inserts are inserted at the side and are therefore very well protected against dirt and moisture.

- Cardboard inserts available in the appropriate size
- Scanner readable
- For inserting into KANBAN panels
- Suitable for KLT or Euroboxes



KAN-Label Kanban sleeves

Order no.	+ Colour code										Inner / Outer dim. (WxH) (mm)	Inlay	Pack
	01	02	03	04	05	06	08	88	20 <th>20</th>	20			
KL100-	01	02	03	04	05	06	08	88	20	20	200 x 67/209 x 74	ET670	50 Pcs.
KAN-LABEL1/3DIN/	1	2	3	4	5	6	8	88	20	20	200 x 85/209 x 99	ET85	50 Pcs.
KAN-LABELA5/	1	2	3	4	5	6	8	88	20	20	200 x 135/209 x 147	ET135	50 Pcs.

Cardboard inserts (Inlays) on page 83



KANBAN SLEEVES KLMU



Due to the 2 neodymium magnets welded into the head section, the KANBAN sleeve can also be securely attached to uneven or round surfaces (barrels/reels).

- Magnets with high adhesive force
- Scanner-readable QR code/barcode
- Suitable for VDA document holders
- Cardboard inserts available in the suitable size



KLMU Kanban sleeves

Order no.	+ Colour code	Inner / Outer dim. (WxH) (mm)	Inlay	Pack
KLMU100-	01 02 03 04 05 06 08 88 20	200 x 67/210 x 85	ET670	50 Pcs.

Cardboard inserts (Inlays) on page 83



KANBAN SLEEVES KNTA



Same design as KAN label, but with Euro perforation and additional slot perforation in the head section for hanging.

- Cardboard inserts available in the appropriate size
- Scanner readable



KNTA Kanban sleeves

Order no.	+ Colour code	Inner / Outer dim. (WxH) (mm)	Inlay	Pack
KNTA-	01 02 03 04 05 06 08 88 20	150 x 67/209 x 85	ET650	50 Pcs.

Cardboard inserts (Inlays) on page 83



LABEL HOLDER INSERTABLE



Made out of transparent rigid PVC for insertion.

- Secure hold
- Dust-protected
- Scanner readable
- UV-resistant
- Easy handling
- Easy insertion and removal



Label holder insertable

Outer Dim. (WxH) (mm)	Order no.	For LF	Inlay	Pack
75 x 22	KLT22-75	LF211, LF221, 14/7-5	ET275	50 Pcs.
75 x 26	KLT26-75	14/7-3ZD	ET230	50 Pcs.
78 x 36	KLT36-78	LF511 GZW	ET378	50 Pcs.
102 x 36	KLT36-102	LF221, LF321, LF322, LF531G, LF532, 14/7-4, 14/7-3Z, 14/7-2H, 14/7-1	ET302	50 Pcs.
102 x 43	KLT43-102	LF533, LF543G, 14/7-3, 14/7-Gr.2	ET402	50 Pcs.

Cardboard inserts (Inlays) on page 83



FABRIC TAPE-DOTS LONGLIFE



Unlimited application possibilities!

The LongLife fabric adhesive tape is a PE-coated, dense, fine threaded and waterproof synthetic silk fabric with a highly adhesive, shear-resistant natural rubber adhesive with very good ageing resistance. It is also available in many colours and is perfect for industrial labelling. Can be used both indoors and outdoors.

- Very good ageing resistance
- For indoor and outdoor areas
- Resistance to abrasion, decomposition and moisture
- Firm texture
- Dense, fine-threaded, and waterproof synthetic silk fabric tape



LongLife Fabric Tape-Dots

Version	Format (Ø) (mm)	Order no.	+ Colour code	Dots	Roll length
Dots	30	LGGW30-P-	01 02 - 04 05 06 07 88	4000	-



SHELF LABEL LING

Long search times in the warehouse are inconceivable given the demands placed on companies nowadays. A coordinate system as the basis for the clear allocation of goods to storage locations provides a remedy. An elaborate numeric key is derived from the coordinates of a storage location and thus ensures clear spatial identification.



[katalog.orgatex.com/
shelflabelling](https://katalog.orgatex.com/shelflabelling)

Label carrier, transparent	From 64
Round tube label carrier	64
Label carrier, magnetic/self-adhesive	65
Label carrier, coloured	From 68
Colour label carrier, magnetic	68
Label Top label carrier, magnetic/self-adhesive	70
Label Plus label carrier, magnetic/self-adhesive	72
Mega Label carrier, magnetic/self-adhesive	74
Magnetic labels/-tape, coloured	From 76
Magnetic labels	76
Magnet-blanks	78
Self-adhesive Magnetic tape	79
Flex sign, self-adhesive	80
Cardboard inserts	82
Individual shelf labelling	84

For this system to work in practice, optimum labelling is required: clearly visible labelling on rows of shelves, shelving compartments and storage levels. At ORGATEX® you will find the right labelling for all areas and purposes: whether magnetic or self-adhesive, coloured, or transparent, for permanent or temporary attachment.

Our self-adhesive Quick-Label inserts are particularly suitable for fixed storage locations and variable items.

Using a foam adhesive, they adhere easily to shelves, pallets, and containers. Our magnetic storage labels are used for metal surfaces. We have designed all versions so that documents can be easily inserted and replaced. Due to the transparent clear profile, error-free scanning of barcodes does not pose a problem.

Tubular shelving systems can also be clearly labelled using our round tube label holders.



INFOGRAPHIC SHELF LABELLING

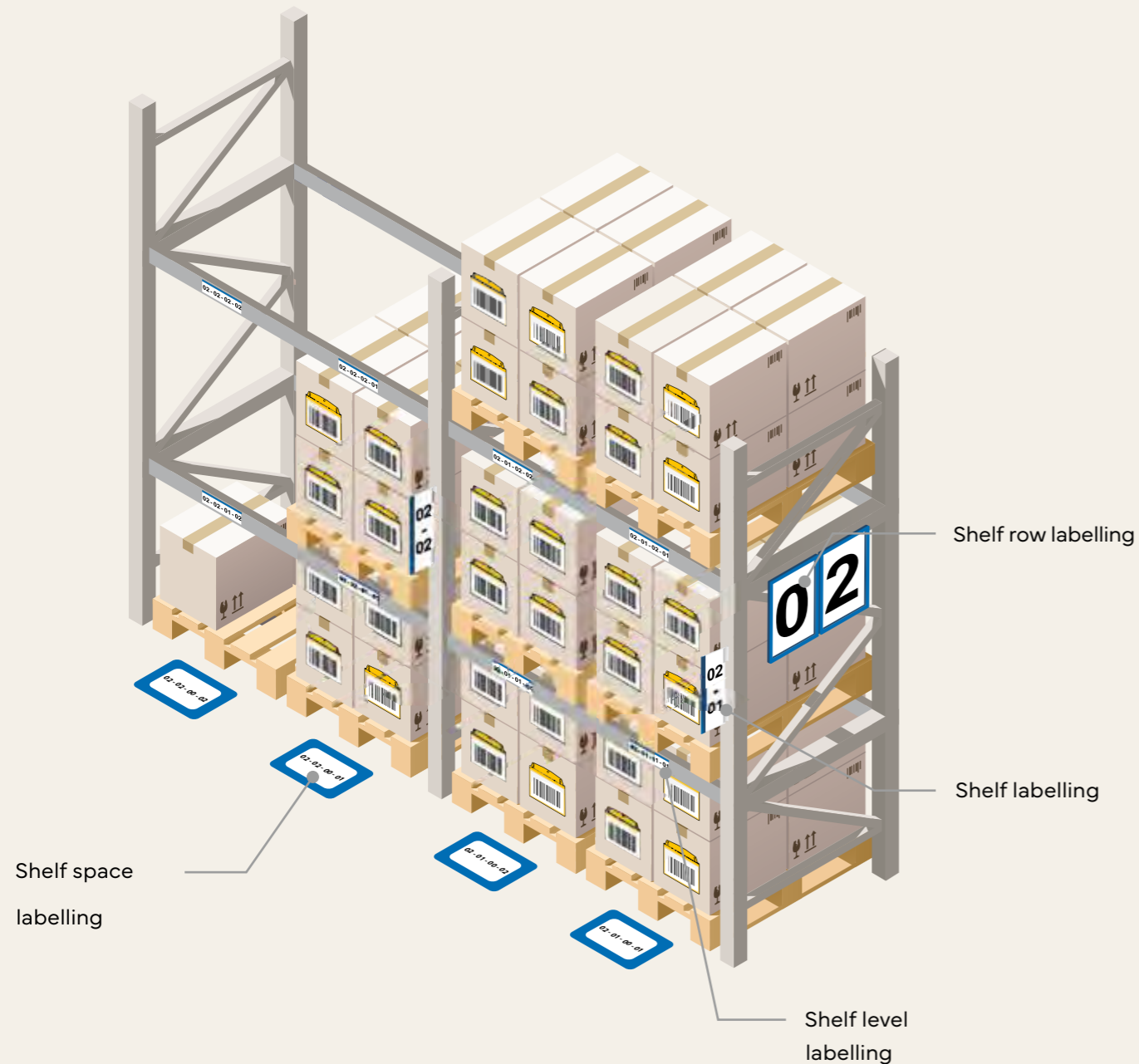

Clear definition of a storage location



For flexible or permanent labelling

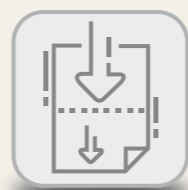

Pre-punched cardboard inlays to ensure precise printing





ROUND TUBE LABEL HOLDER



Due to its ergonomic shape, the label holder forms a single unit with the profile or tube. The sturdy transparent profile is open at the sides and top, making it easy to change the matching cardboard inserts.

The 2-component design provides the clip with both stability and flexibility. Whether round tube or profile tube, specially arranged grip points on the inside provide a secure hold all around.



Format (width) (mm)	Order no.	Gripper per pack	Inlay	Pack
100	VST-Label-100	100 Pcs.	ET335	50 Pcs.
200	VST-Label-200	100 Pcs.	-	50 Pcs.
-	VST-GRIPPER	-	-	50 Pcs.

Cardboard inserts (Inlays) on page 83



LABEL HOLDERS MAGNETIC/SELF-ADHESIVE



The sturdy transparent profile is open at the sides and top. This means that not only can suitable cardboard inserts be easily inserted and exchanged, but also larger receipts, accompanying documents or additional information are always ready to hand. The sturdy label holders are equipped with a foam adhesive or a full surface magnetic film on the back. The transparent clear profile enables error-free scanning of barcodes.

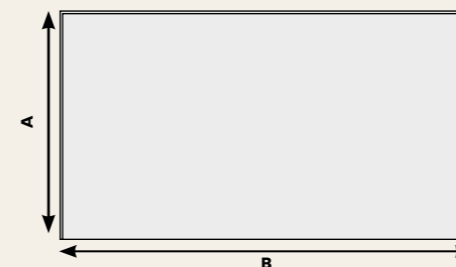

Existing formats in mm, outer dimensions					
A	20	27	38	47	67
B	75	75	75	75	100
B	100	100	100	100	150
B	150	150	150	150	200



LABEL HOLDERS

MAGNETIC/SELF-ADHESIVE

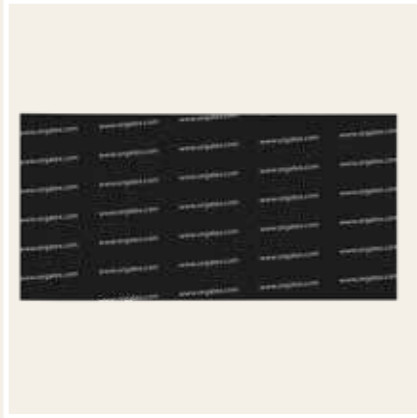

Label holders, magnetic

Format (HxW) (mm)	Order no.	Inlay	Pack
20 x 75	HE120-75	ET190	100 Pcs.
20 x 100	HE120-100	ET210	100 Pcs.
20 x 150	HE120-150	ET220	100 Pcs.
27 x 75	HE127-75	ET75	100 Pcs.
27 x 100	HE127-100	ET100	100 Pcs.
27 x 150	HE127-150	ET150	100 Pcs.
38 x 75	HE138-75	ET375	100 Pcs.
38 x 100	HE138-100	ET300	100 Pcs.
38 x 150	HE138-150	ET350	100 Pcs.
47 x 75	HE147-75	ET475	100 Pcs.
47 x 100	HE147-100	ET400	100 Pcs.
47 x 150	HE147-150	ET450	100 Pcs.
67 x 100	HE167-100	ET600	100 Pcs.
67 x 150	HE167-150	ET650	100 Pcs.
67 x 200	HE167-200	ET670	100 Pcs.

Cardboard inserts (Inlays) on page 83



Label holders, self-adhesive

Format (HxW) (mm)	Order no.	Inlay	Pack
20 x 75	SL020-75	ET190	100 Pcs.
20 x 100	SL020-100	ET210	100 Pcs.
20 x 150	SL020-150	ET220	100 Pcs.
27 x 75	SL027-75	ET75	100 Pcs.
27 x 100	SL027-100	ET100	100 Pcs.
27 x 150	SL027-150	ET150	100 Pcs.
38 x 75	SL038-75	ET375	100 Pcs.
38 x 100	SL038-100	ET300	100 Pcs.
38 x 150	SL038-150	ET350	100 Pcs.
47 x 75	SL047-75	ET475	100 Pcs.
47 x 100	SL047-100	ET400	100 Pcs.
47 x 150	SL047-150	ET450	100 Pcs.
67 x 100	SL067-100	ET600	100 Pcs.
67 x 150	SL067-150	ET650	100 Pcs.
67 x 200	SL067-200	ET670	100 Pcs.

Cardboard inserts (Inlays) on page 83





LABEL HOLDERS COLOUR MAGNETIC



Label carrier with a 10 mm wide, coloured top edge. The reverse side is fully magnetic. The colour coding makes it easy to distinguish between individual product groups or subject areas.

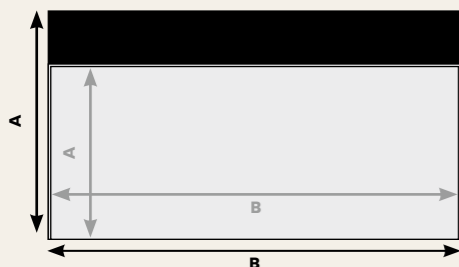

Existing formats in mm, outer / inner dimensions			
A	35/25	48/38	60/50
B	100/100	100/100	100/100
B	150/150	150/150	150/150

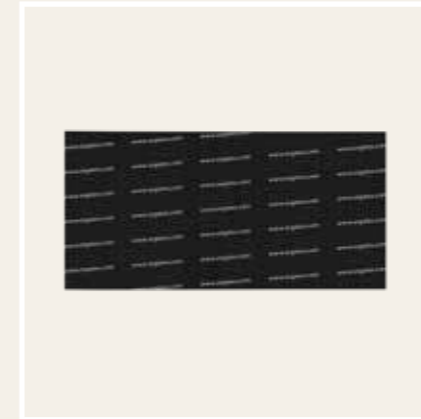

Colour								
Format (HxW) (mm)	Order no.	+ Colour code					Inlay	Pack
		1	2	3	4	5		
35 x 100	HE525-100/	1	2	3	4	5	ET200	50 Pcs.
35 x 100	HE225-100/	1	2	3	4	5	ET200	100 Pcs.
35 x 150	HE525-150/	1	2	3	4	5	ET250	50 Pcs.
35 x 150	HE225-150/	1	2	3	4	5	ET250	100 Pcs.
48 x 100	HE538-100/	1	2	3	4	5	ET300	50 Pcs.
48 x 100	HE238-100/	1	2	3	4	5	ET300	100 Pcs.
48 x 150	HE538-150/	1	2	3	4	5	ET350	50 Pcs.
48 x 150	HE238-150/	1	2	3	4	5	ET350	100 Pcs.
60 x 100	HE550-100/	1	2	3	4	5	ET500	50 Pcs.
60 x 100	HE250-100/	1	2	3	4	5	ET500	100 Pcs.
60 x 150	HE550-150/	1	2	3	4	5	ET550	50 Pcs.
60 x 150	HE250-150/	1	2	3	4	5	ET550	100 Pcs.

Cardboard inserts (Inlays) on page 83





LABEL HOLDERS LABEL TOP MAGNETIC/SELF-ADHESIVE



Label holder for cardboard inserts. The openings at the side and top allow you to quickly insert suitable and larger documents, e.g. for additional information.

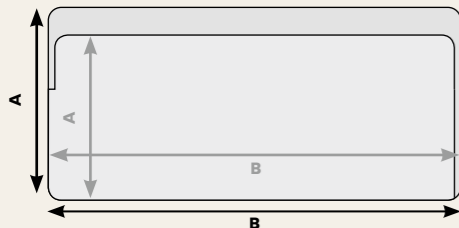

Existing formats in mm, outer / inner dimensions

A	35/25	50/38	80/67
B	107/100	107/100	160/100



Label top, 1 magnetic strip

Format inner/ outside Dim. (HxW) (mm)	Order no.	+ Colour code								Inlay	Pack
		1	2	3	4	5	6	8	88		
25 x 100/ 35 x 107	LTM110-35/	1	2	3	4	5	6	8	88	ET200	50 Pcs.
38 x 100/ 50 x 107	LTM110-50/	1	2	3	4	5	6	8	88	ET300	50 Pcs.
67 x 150/ 80 x 160	LTM160-80/	1	2	3	4	5	6	8	88	ET650	50 Pcs.

Cardboard inserts (Inlays) on page 83



Label Top, 2 magnetic strip

Format inner/ outside Dim. (HxW) (mm)	Order no.	+ Colour code								Inlay	Pack
		1	2	3	4	5	6	8	88		
67 x 150/ 80 x 160	LTV160-80/	1	2	3	4	5	6	8	88	ET650	50 Pcs.

Cardboard inserts (Inlays) on page 83



Label Top, 1 foam adhesive strip

Format inner/ outside Dim. (HxW) (mm)	Order no.	+ Colour code								Inlay	Pack
		1	2	3	4	5	6	8	88		
25 x 100/ 35 x 107	LTS110-35/	1	2	3	4	5	6	8	88	ET200	50 Pcs.
38 x 100/ 50 x 107	LTS110-50/	1	2	3	4	5	6	8	88	ET300	50 Pcs.
67 x 150/ 80 x 160	LTS160-80/	1	2	3	4	5	6	8	88	ET650	50 Pcs.

Cardboard inserts (Inlays) on page 83





LABEL HOLDERS LABEL PLUS MAGNETIC/SELF-ADHESIVE



Coloured label holders, available in magnetic or self-adhesive versions. Label Plus is open at the top. Labels are easy to insert and hold securely in place.

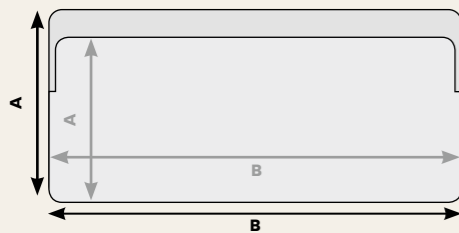

Existing formats in mm, outer / inner dimensions			
A	35/25	50/38	80/67
B	107/100	107/100	160/150



Label Plus, 1 magnetic strip											
Format inner/ outside Dim. (HxW) (mm)	Order no.	+ Colour code								Inlay	Pack
		1	2	3	4	5	6	8	88		
25 x 100/ 35 x 107	LPM110-35/	1	2	3	4	5	6	8	88	ET200	50 Pcs.
38 x 100/ 50 x 107	LPM110-50/	1	2	3	4	5	6	8	88	ET300	50 Pcs.
67 x 150/ 80 x 160	LPM160-80/	1	2	3	4	5	6	8	88	ET650	50 Pcs.

Cardboard inserts (Inlays) on Page 83



Label Plus, 2 magnetic strips											
Format inner/ outside Dim. (HxW) (mm)	Order no.	+ Colour code								Inlay	Pack
		1	2	3	4	5	6	8	88		
67 x 150/ 80 x 160	LPV160-80/	1	2	3	4	5	6	8	88	ET650	50 Pcs.

Cardboard inserts (Inlays) on Page 83



Label Plus, 1 foam adhesive strip											
Format inner/ outside Dim. (HxW) (mm)	Order no.	+ Colour code								Inlay	Pack
		1	2	3	4	5	6	8	88		
25 x 100/ 35 x 107	LPS110-35/	1	2	3	4	5	6	8	88	ET200	50 Pcs.
38 x 100/ 50 x 107	LPS110-50/	1	2	3	4	5	6	8	88	ET300	50 Pcs.
67 x 150/ 80 x 160	LPS160-80/	1	2	3	4	5	6	8	88	ET650	50 Pcs.

Cardboard inserts (Inlays) on Page 83



LABEL HOLDERS MEGA

MAGNETIC/SELF-ADHESIVE



The large MEGA label carriers are hard-wearing plastic labels with a transparent front, welded at the top and bottom so that the matching cardboard insert can be easily inserted from the right or left.

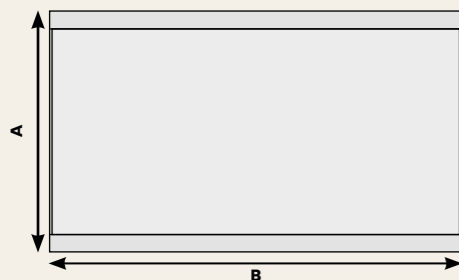

Existing formats in mm, outer dimensions		
A	60	80
B	100	100
B	150	150
B	200	200
B	300	300
B	600	600



MEGA, magnetic

Format (HxW) (mm)	Order no.	+ Colour code										Inlay	Pack
		1	2	3	4	5	6	8	88	20	95		
60 x 100	HEM360-100/	1	2	3	4	5	6	8	88	20	ET500	50 Pcs.	
60 x 150	HEM360-150/	1	2	3	4	5	6	8	88	20	ET550	50 Pcs.	
60 x 200	HEM360-200/	1	2	3	4	5	6	8	88	20	ET520	50 Pcs.	
60 x 300	HEM360-300/	1	2	3	4	5	6	8	88	20	ET700	25 Pcs.	
60 x 600	HEM360-600/	1	2	3	4	5	6	8	88	20	ET730	10 Pcs.	
80 x 100	HEM380-100/	1	2	3	4	5	6	8	88	20	ET600	50 Pcs.	
80 x 150	HEM380-150/	1	2	3	4	5	6	8	88	20	ET650	50 Pcs.	
80 x 200	HEM380-200/	1	2	3	4	5	6	8	88	20	ET670	50 Pcs.	
80 x 300	HEM380-300/	1	2	3	4	5	6	8	88	20	ET800	25 Pcs.	
80 x 600	HEM380-600/	1	2	3	4	5	6	8	88	20	ET830	10 Pcs.	

Cardboard inserts (Inlays) on page 83

MEGA self-adhesive

Format (HxW) (mm)	Order no.	+ Colour code										Inlay	Pack
		1	2	3	4	5	6	8	88	20	95		
60 x 100	HES460-100/	1	2	3	4	5	6	8	88	20	ET500	50 Pcs.	
60 x 150	HES460-150/	1	2	3	4	5	6	8	88	20	ET550	50 Pcs.	
60 x 200	HES460-200/	1	2	3	4	5	6	8	88	20	ET520	50 Pcs.	
60 x 300	HES460-300/	1	2	3	4	5	6	8	88	20	ET700	25 Pcs.	
60 x 600	HES460-600/	1	2	3	4	5	6	8	88	20	ET730	10 Pcs.	
80 x 100	HES480-100/	1	2	3	4	5	6	8	88	20	ET600	50 Pcs.	
80 x 150	HES480-150/	1	2	3	4	5	6	8	88	20	ET650	50 Pcs.	
80 x 200	HES480-200/	1	2	3	4	5	6	8	88	20	ET670	50 Pcs.	
80 x 300	HES480-300/	1	2	3	4	5	6	8	88	20	ET800	25 Pcs.	
80 x 600	HES480-600/	1	2	3	4	5	6	8	88	20	ET830	10 Pcs.	

Cardboard inserts (Inlays) on page 83



MAGNETIC LABELS



ORGATEX® magnetic storage labels made of particularly high-quality magnetic foil.

- Guarantee a secure hold on all ferrous surfaces
- Installed and implemented in seconds

This ensures that labelling in the warehouse is always up-to-date, clean and clear. 5 different colours provide additional differentiation at first glance.

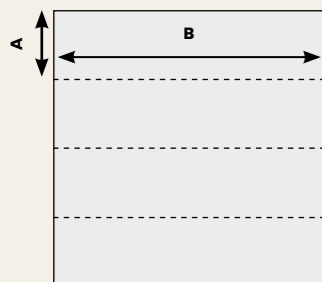
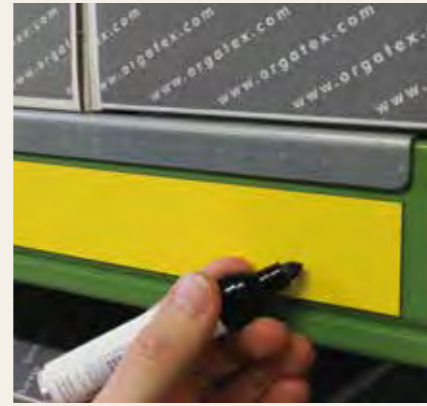

Existing formats in mm, outer dimensions

A	20	25	30	35	40	50	60	70
B	60	60	60	60	60	60	60	60
B	75	75	75	75	75	75	75	75
B	100	100	100	100	100	100	100	100
B	150	150	150	150	150	150	150	150

Magnetic storage labels (shelf labels)

Format (HxW) (mm)	Order no.	+ Colour code					Pack
		1	2	3	4	5	
20 x 60	MR60-20/	1	2	3	4	5	100 Pcs.
20 x 75	MR75-20/	1	2	3	4	5	100 Pcs.
20 x 100	MR100-20/	1	2	3	4	5	100 Pcs.
20 x 150	MR150-20/	1	2	3	4	5	100 Pcs.
25 x 60	MR60-25/	1	2	3	4	5	100 Pcs.
25 x 75	MR75-25/	1	2	3	4	5	100 Pcs.
25 x 100	MR100-25/	1	2	3	4	5	100 Pcs.
25 x 150	MR150-25/	1	2	3	4	5	100 Pcs.
30 x 60	MR60-30/	1	2	3	4	5	100 Pcs.
30 x 75	MR75-30/	1	2	3	4	5	100 Pcs.
30 x 100	MR100-30/	1	2	3	4	5	100 Pcs.
30 x 150	MR150-30/	1	2	3	4	5	100 Pcs.
35 x 60	MR60-35/	1	2	3	4	5	100 Pcs.
35 x 75	MR75-35/	1	2	3	4	5	100 Pcs.
35 x 100	MR100-35/	1	2	3	4	5	100 Pcs.
35 x 150	MR150-35/	1	2	3	4	5	100 Pcs.
40 x 60	MR60-40/	1	2	3	4	5	100 Pcs.
40 x 75	MR75-40/	1	2	3	4	5	100 Pcs.
40 x 100	MR100-40/	1	2	3	4	5	100 Pcs.
40 x 150	MR150-40/	1	2	3	4	5	100 Pcs.
50 x 60	MR60-50/	1	2	3	4	5	100 Pcs.
50 x 75	MR75-50/	1	2	3	4	5	100 Pcs.
50 x 100	MR100-50/	1	2	3	4	5	100 Pcs.
50 x 150	MR150-50/	1	2	3	4	5	100 Pcs.
60 x 60	MR60-60/	1	2	3	4	5	100 Pcs.
60 x 75	MR75-60/	1	2	3	4	5	100 Pcs.
60 x 100	MR100-60/	1	2	3	4	5	100 Pcs.
60 x 150	MR150-60/	1	2	3	4	5	100 Pcs.
70 x 60	MR60-70/	1	2	3	4	5	100 Pcs.
70 x 75	MR75-70/	1	2	3	4	5	100 Pcs.
70 x 100	MR100-70/	1	2	3	4	5	100 Pcs.
70 x 150	MR150-70/	1	2	3	4	5	100 Pcs.



MAGNETIC BLANKS



Magnetic tapes for cutting to size

Format (HxW) (mm)	Order no.	+ Colour code					Pack
		1	2	3	4	5	
10 x 600	MB710/	1	2	3	4	5	10 Pcs.
15 x 600	MB715/	1	2	3	4	5	10 Pcs.
20 x 600	MB720/	1	2	3	4	5	10 Pcs.
25 x 600	MB725/	1	2	3	4	5	10 Pcs.
30 x 600	MB730/	1	2	3	4	5	10 Pcs.
35 x 600	MB735/	1	2	3	4	5	10 Pcs.
40 x 600	MB740/	1	2	3	4	5	10 Pcs.
50 x 600	MB750/	1	2	3	4	5	10 Pcs.
60 x 600	MB760/	1	2	3	4	5	10 Pcs.
70 x 600	MB770/	1	2	3	4	5	10 Pcs.
75 x 600	MB775/	1	2	3	4	5	10 Pcs.
80 x 600	MB780/	1	2	3	4	5	10 Pcs.
90 x 600	MB790/	1	2	3	4	5	10 Pcs.
100 x 600	MB800/	1	2	3	4	5	10 Pcs.



Magnetic sheets for cutting to size

Format (HxW) (mm)	Order no.	+ Colour code					Pcs.
		1	2	3	4	5	
200 x 300	R262/	1	2	3	4	5	1 Pcs.
300 x 600	R512/	1	2	3	4	5	1 Pcs.
400 x 600	R513/	1	2	3	4	5	1 Pcs.
600 x 600	R514/	1	2	3	4	5	1 Pcs.



SELF-ADHESIVE MAGNETIC TAPE



The full-surface adhesive on the back makes it possible to attach non-magnetic objects, e.g. warning or information signs made of aluminium or plastic, to metal doors and gates. The flexible material also allows attachment to non-planar surfaces such as barrels or pipes.

- High adhesive force
- Can be shortened with scissors or cutter knife
- Fully magnetic
- Flexible
- Material thickness: 0.75 mm



Self-adhesive magnetic tape

Format (HxB) (mm)	Order no.	Pack
20 x 600	SMB520	10 Pcs.
25 x 600	SMB525	10 Pcs.
30 x 600	SMB530	10 Pcs.
35 x 600	SMB535	10 Pcs.
40 x 600	SMB540	10 Pcs.
50 x 600	SMB550	10 Pcs.
60 x 600	SMB560	10 Pcs.
70 x 600	SMB570	10 Pcs.
75 x 600	SMB575	10 Pcs.
80 x 600	SMB580	10 Pcs.
100 x 600	SMB600	10 Pcs.



FLEX SIGN SELF-ADHESIVE



The flex sign is suitable for shelf, storage and storage space labelling. Made out of a special rigid film, it enables flexible labelling (the sign springs back into its original position when jolted). The sign is attached using 2 flex grippers, which are included as part of the delivery.



Flex sign, self-adhesive

Format (WxH) (mm)	Order no.	+ Colour code								For documents/ inlay (ET)	Pack
		01	02	03	04	05	06	20	88		
67 x 300	FX-SK-67-	01	02	03	04	05	06	20	88	ET800	10 Pcs.
110 x 300	FX-SK-	01	02	03	04	05	06	20	88	1/2 DIN A4	10 Pcs.
210 x 300	FX-SK-A4-	01	02	03	04	05	06	20	88	DIN A4	10 Pcs.

Cardboard inserts (Inlays) on page 83

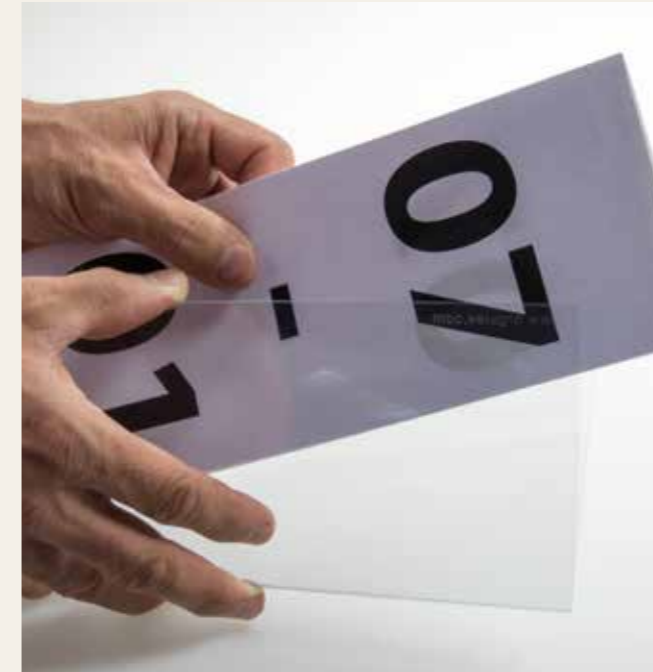



CARDBOARD INSERTS, INLAY (ET)

Clean and easy to design cardboard inserts are the basic requirement for clear shelf/container labelling and can also be used as KANBAN or Heijunka cards.

Due to the all-round micro-perforation, the cardboard inserts can be removed without leaving any residue and without the need for scissors or a cutter knife.

Customised printing is simplified by the free print templates for all formats available at orgatex.com.

The designed sheets can be printed on all commercially available printers. This minimises the amount of handling required to create and design cardboard inserts.

The combination with ORGATEX® protective covers or document holders creates a long-lasting product.



Cardboard inserts, Inlay (ET)

Order no.	Format (WxH) (mm)	Cardboard inserts, Inlays/pack	Sheets
ET75	75 x 27	200	10 Pcs.
ET85	200 x 85	30	10 Pcs.
ET100	100 x 27	200	10 Pcs.
ET135	200 x 135	20	10 Pcs.
ET150	150 x 27	100	10 Pcs.
ET190	75 x 20	280	10 Pcs.
ET200	100 x 25	220	10 Pcs.
ET210	100 x 20	280	10 Pcs.
ET220	150 x 20	140	10 Pcs.
ET230	75 x 25	220	10 Pcs.
ET250	150 x 25	110	10 Pcs.
ET275	75 x 22	260	10 Pcs.
ET300	100 x 38	140	10 Pcs.
ET302	102 x 36	160	10 Pcs.
ET335	100 x 35	160	10 Pcs.
ET350	150 x 38	70	10 Pcs.
ET375	75 x 38	140	10 Pcs.
ET378	78 x 36	160	10 Pcs.
ET400	100 x 47	120	10 Pcs.
ET402	102 x 43	120	10 Pcs.
ET450	150 x 47	60	10 Pcs.
ET475	75 x 47	120	10 Pcs.
ET500	100 x 50	100	10 Pcs.
ET520	200 x 50	50	10 Pcs.
ET550	150 x 50	50	10 Pcs.
ET600	100 x 67	80	10 Pcs.
ET650	150 x 67	40	10 Pcs.
ET670	200 x 67	40	10 Pcs.
ET700	300 x 50	40	10 Pcs.
ET730	600 x 50	50	50 Pcs.
ET800	300 x 67	60	20 Pcs.
ET830	600 x 67	50	50 Pcs.
ET76-70	76 x 70	80	10 Pcs.
ET33-75K-01/02/04/05	75 x 33	160	10 Pcs.
ET105-148	105 x 148	40	10 Pcs.



INDIVIDUAL SHELF LABELLING

Using ORGATEX®, you can create customised storage bin labels according to your requirements. It is possible to print different contents on the labels – e.g. texts, barcodes, symbols. You can also choose between 3 different materials (foil, polycarbonate and magnetic foil).

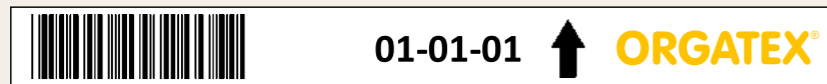
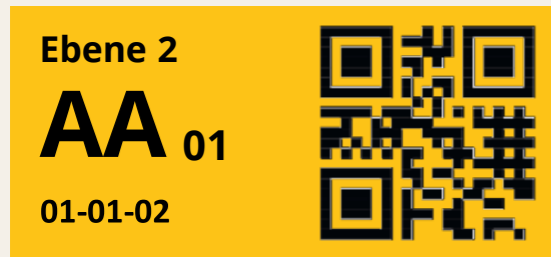

DIMENSIONS FOR STANDARD SIZES

Single-user labels

20 x 90	20 x 120	
35 x 90	35 x 120	35 x 180
50 x 90	50 x 120	50 x 180
70 x 90	70 x 120	70 x 180
90 x 90	90 x 120	90 x 180

Multilevel labels

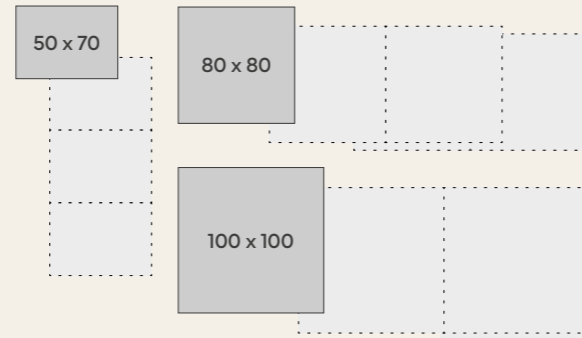

If you are interested in samples or planning your labels, please contact our sales team:
 Mail: sales@orgatex.de
 Phone: +49 2173-1064-0



INDIVIDUAL SHELF LABELLING



Plastic labels, reinforced

- Extremely resistant
- Very well suited for slots in the profile
- Self-adhesive
- Abrasion-resistant printing
- Material: Polycarbonate
- Material thickness: 0.7 mm
- Surface: matt
- Adhesive: acrylate
- Area of application: Indoor use

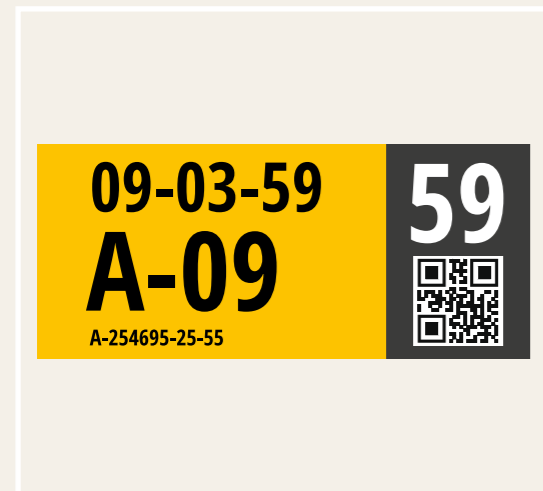

Foil labels

- For smooth, gap-free substrates
- Self-adhesive, resistant, easy to apply
- High tear resistance
- Abrasion-resistant solvent printing
- Material: foil
- Material thickness: 0.2 mm
- Surface: matt or glossy
- Protective laminate: on request
- Adhesive: acrylate
- Area of application: interior

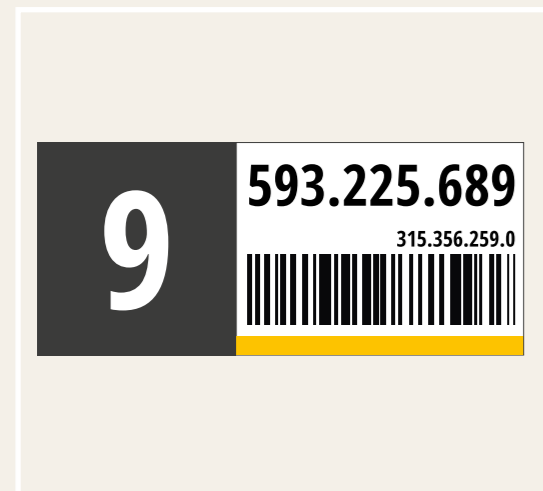

Magnetic labels

- Attachment to magnetic surfaces
- For variable shelf space labelling
- Different magnet variants (e.g. for frozen areas)
- Quick and residue-free replacement
- Flexible use
- Material: Magnetic foil
- Material thickness: 0.85 mm
- Surface: matt
- Protective laminate: on request
- Area of application: Indoor use



REQUIRED ORDER DETAILS

General information:

1. Specify your desired layout and format
2. For labels with logos or graphics, we require a print-ready template (300 dpi - AI, EPS, TIFF, SVG)
3. We will send you a proof copy for approval
4. The labels will be dispatched as soon as possible after approval

Information on the required Excel spreadsheet:

1. A separate column must be used for each piece of information on your label (plain text, barcodes, etc.)
2. The column names must be distinct (e.g. barcode 1, barcode 2)
3. For each individual label, the use of a separate line is necessary (see fig. below)
4. For arrows (bottom, top, right, left) or symbols, use directional information or plain text (no graphics)
5. Please only use fixed values and not formulae, data sheets, safety instructions, application videos, etc.



	A	B	C	D	E
1	Arrow	Logo	Colour	QR-Code	Number
2	Above	ORGATEX	White	23548626	758.236.952
3	Above	ORGATEX	White	23548627	758.236.953

	A	B	C	D	E	F	G	H
1	Barcode 1	Level 1	Text below 1	Colour 1	Barcode 2	Level 2	Text below 2	Colour 2
2	70569010	8.3.10.1	10	Grey	8621684	8.4.20.1	20	Orange
3	70569020	8.3.10.2	20	Grey	8621685	8.4.20.2	40	Orange
4	70569030	8.3.10.3	30	Grey	8621686	8.4.20.3	60	Orange



katalog.orgatex.com/
druckvorlagen



FLOOR MARKING

Whether it is driveways and walkways, danger zones or storage areas – correct labelling is a must. Clear floor markings increase work safety and make it easier to comply with regulations. As the markings on the floor are exposed to particular loads, they must be extremely hardwearing.



[katalog.orgatex.com/
bodenmarkierung](https://katalog.orgatex.com/bodenmarkierung)

LongLife floor marking tape

Low Duty	98
LongLife floor marking tape	100
Individual	102
FTS	104
Grip	106
Heavy Duty	107
Outdoor	108

eOX-Spot

110

LongLife symbols/blanks

From 114

LongLife symbols	114
LongLife symbols rounded	116
LongLife symbols foot and arrow	118
LongLife symbols heavy duty	120
LongLife symbols heavy duty rounded	122

LongLife Module

From 124

LongLife Module	124
LongLife Module L-angle	126

LongLife clear view

From 128

Set for parking space markings

From 130

LongLife cold performance

From 132

LongLife accessories

134

Remover	135
Cleaner	135
Primer	135
NEW! Edge sealing	135
Trimming system	136
NEW! Pressure roller	137

ORGATEX® has been setting the standard in the field of self-adhesive floor markings for years: Our long-life floor markings made of torsion-resistant, high-quality plastic distinguish themselves by their extreme resilience. They are „forklift-proof“ and can even withstand turning on the marking. They are quick and easy to apply and can be removed again without leaving any residue thanks to our LongLife Remover. Our floor markings are used indoors and adhere to all surfaces such as concrete, stone and metal. They are available

in a wide variety of designs: Available in rolls our floor markings are used to designate traffic routes, parking spaces as well as work and safety areas.

With our comprehensive range of labelling signs, you can ensure standardised safety in your company. Our portfolio also includes various symbols as orientation aids or for marking floor windows as well as parking spaces.



INFOGRAPHIC FLOOR MARKING

Labelling of parking spaces

When fixing the floor marking minimum distance of 30 to 50 mm should be maintained

Create your own floor marking in DIN format



Quick and easy installation. Self-adhesive and torsion resistant.



Various material thickness for all requirements



Colour coding of walkways and parking spaces



LongLife Cold Performance
Self-adhesive floor marking for areas with extremely low ambient temperatures (adhesion temperature to -20°C)

Common format sizes

Common 5S colours, single-coloured and two-coloured

LongLife floor marking tape
is made of torsion-resistant, high-quality plastic and has a high abrasion resistance. Easy to apply directly from the roll dispenser.

Forklift proof







LongLife symbols
Easy marking of parking and restricted areas. The highly adhesive industrial glue on the back is suitable for all surfaces such as concrete, stone, metal, etc. Different colours, widths and shapes allow for clear allocation of functional areas.

LongLife floor marking signs
Made of PVC and fully bonded. Extremely hard-wearing and wear resistant. Complies with the standards and regulations in accordance with ASR A1.3.



VERSION MARKING EXAMPLE

RECOMMENDATION COLOUR RANGE

- | | | | |
|---|---|---|--|
|  | Main and secondary routes
Version: Floor marking tape |  | Finished material/delivery area
Version: Blank |
|  | Raw material/delivery areas
Version: Blank |  | Rejects/defective parts
Version: Blank or floor marking tape |
|  | Danger areas
Version: Floor marking tape |  | Empties
Version: Floor marking tape |
|  | Other parking spaces
Version: Blank or floor marking tape | | |



Mandatory action signs prescribe mandatory behaviour in the designated areas. The standardised design in accordance with ASR A1.3 indicates hazards that cannot be clearly identified and actively influences the behaviour of employees. Mandatory signs help to significantly increase work safety.



Warning and information signs are used wherever there is danger, e.g. suspended loads, industrial trucks or noise, that has a direct impact on the employees. With appropriate labelling from ORGATEX® you adhere to the legal requirements.



Prohibition signs have the highest weighting in the group of safety signs. Signs in this category prohibit certain types of behaviour and issue clear prohibitions in order to avoid serious accidents.



Longitudinal markings are used to clearly separate different areas, e.g. of driveways and walkways or storage and production areas. In addition to the safety aspect, clearly marked areas also help to increase efficiency and avoid errors caused by mixing up materials and raw materials. For this purpose, markings in different colours, single or multi-coloured, e.g. hatched, are used and assigned to a use.



Symbols are the ideal tool for clearly visualising a wide variety of areas. Different geometries and a variety of colours can be used to mark logistics and production areas. This allows individual areas such as incoming/outgoing goods, empties, blocking or material provision areas to be clearly assigned to their use.





VERSION MARKING EXAMPLE/PROCESSING

A clear allocation of materials to production or logistics processes is essential to ensure quality and effectiveness.

If the identification of semi-finished or finished products, for example, cannot be clearly guaranteed by the colour of the floor marking alone, it can be 100% achieved by using floor labels. Here, barcodes, article numbers or printed images can be used as additional information in combination with ORGATEX® LongLife transparent labels. The special surface structure of the floor signs refracts the light from the ceiling lighting to enable error-free scanning, e.g. of QR or barcodes, and has an anti-slip effect.



Labelling, e.g. for marking parking spaces, can be printed in standard DIN format on normal paper. In combination with the ORGATEX® LongLife transparent sign this creates an excellently protected floor marking system.

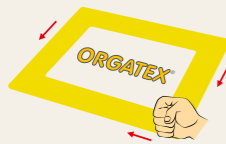

Quickly create your own floor signage: The printout on standard paper is placed behind the specially textured film, which prevents reflections, e.g. from ceiling lights, thereby maintaining scanner readability. All-round adhesive strips protect the printout from external influences such as dust or moisture and form a solid bond with the substrate by simply pressing it down.



Remove dirt, grease and oil from the surface using a cleaner (LongLife Cleaner)



Ideal processing temperature 18 °C to 25 °C



Allow to harden for approx. 12 hours



Do not overlap floor markings!

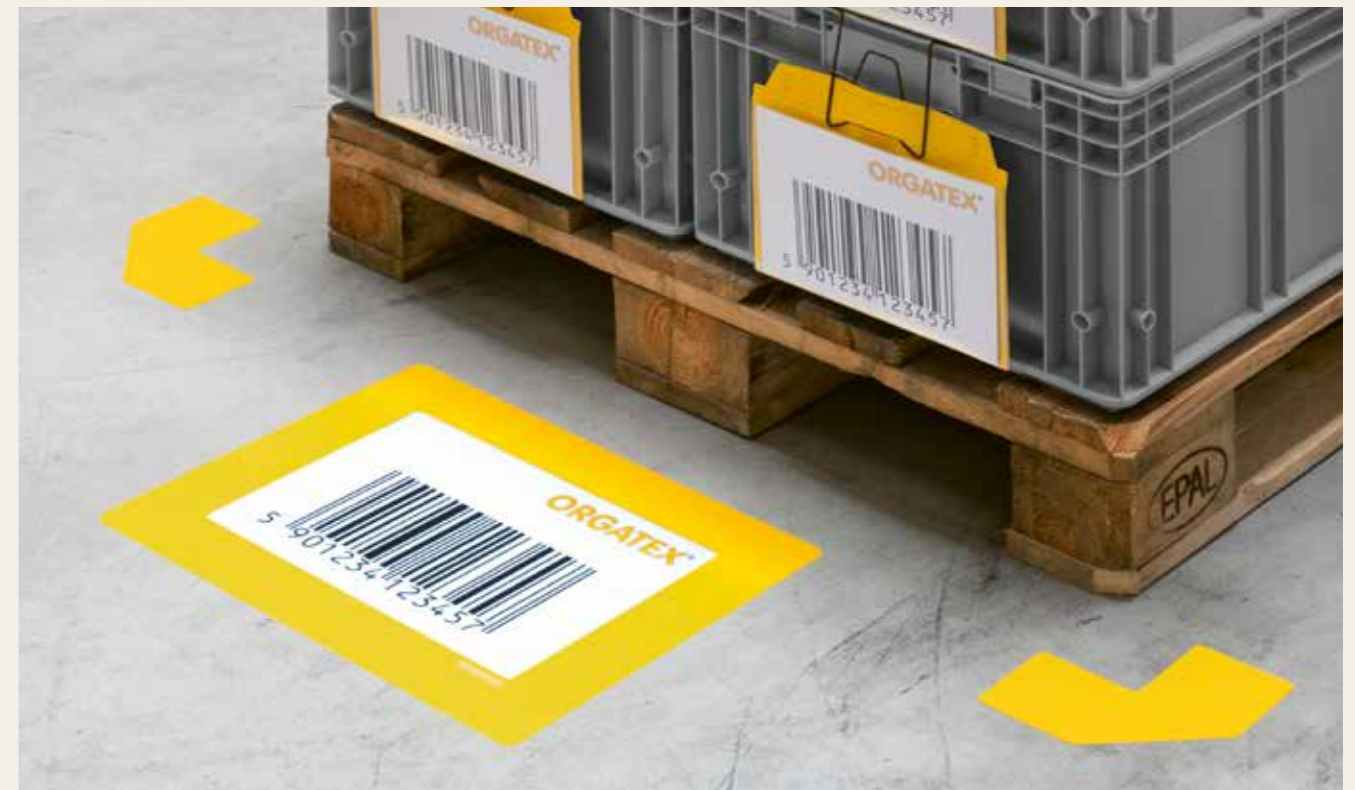
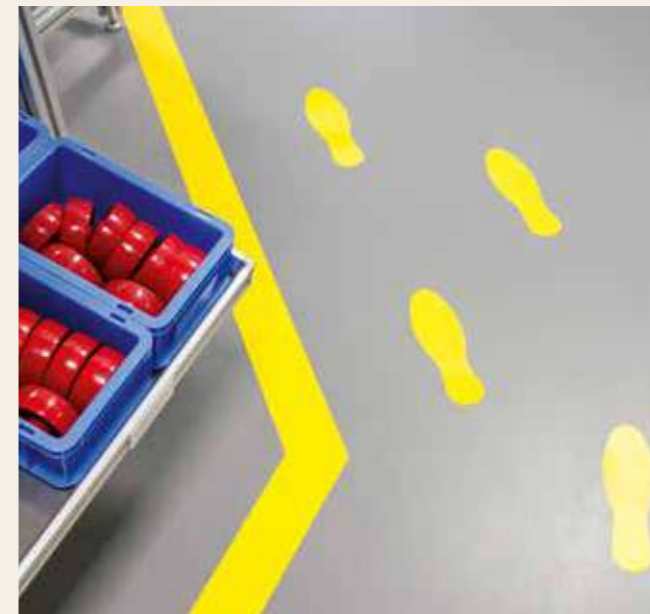
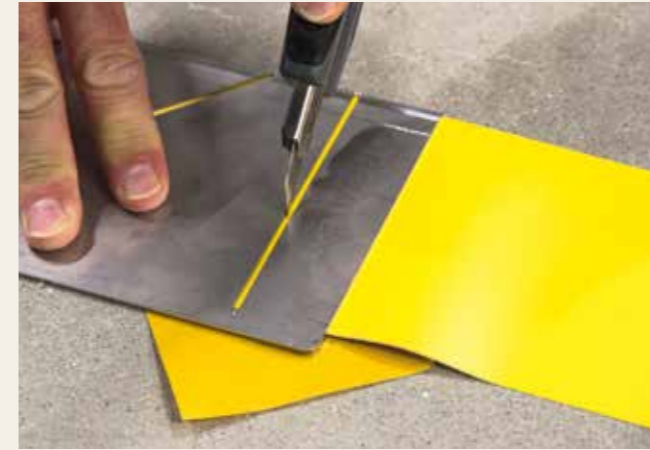



LOGLIFE FLOOR MARKING TAPE PRODUCT RANGE

Find the floor marking you need

Always the right marking – regardless of the floor condition or type of application! You can use our tapes from LongLife with precision and long-term stability against wear and tear: e.g. parking spaces, main and secondary routes or safety areas.

New products, new variety! We have generously expanded our range. New additions are the LongLife products Low Duty (LD), FTS, Grip and Heavy Duty (HD). We are also happy to customise our tape according to your requirements. So you are always guaranteed to find the right solution for your specific needs.

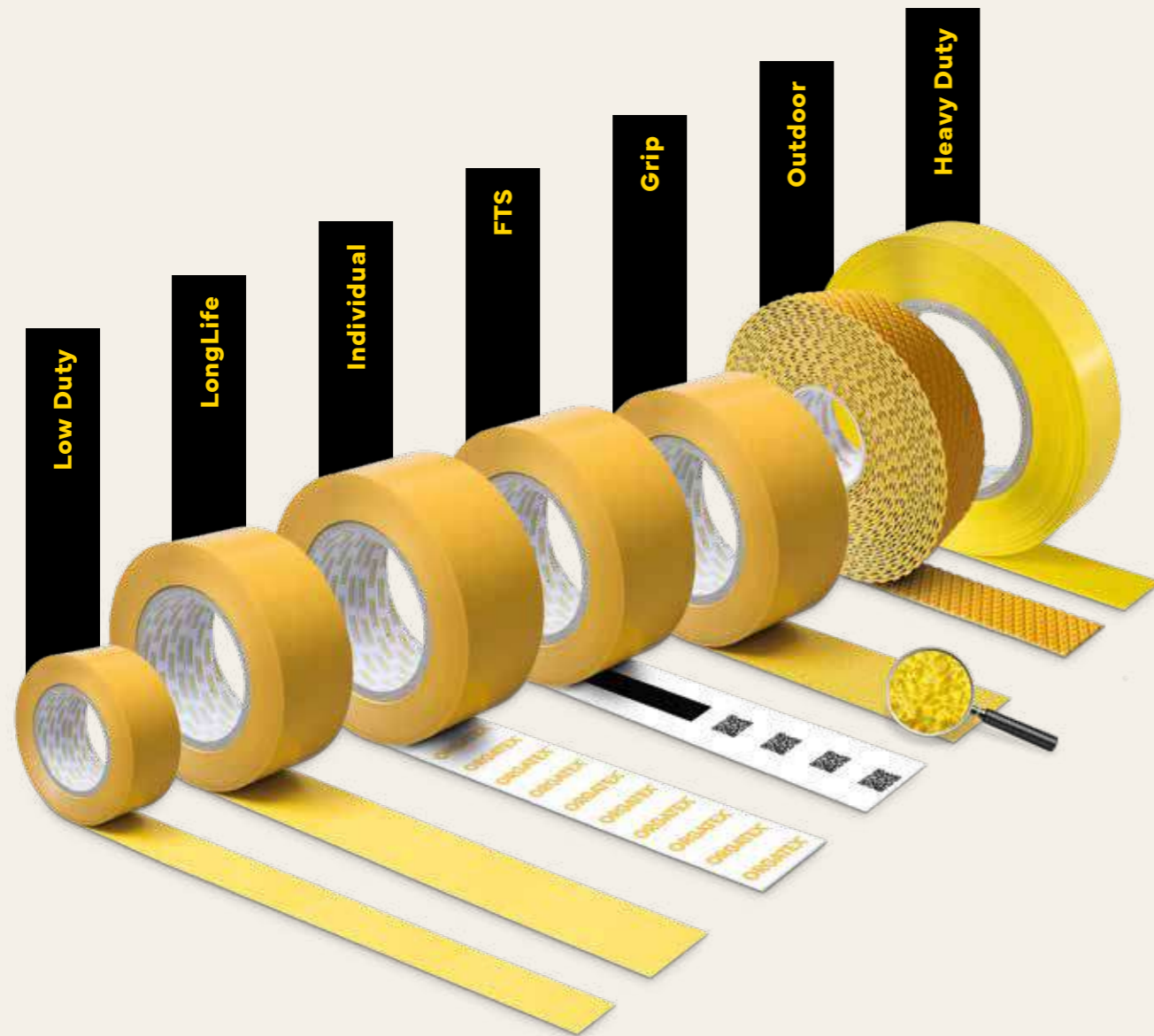

Overview LongLife Floor Marking Tape

	Low Duty	LongLife	Cold Performance	Individual	Outdoor	Grip	Heavy Duty
Pedestrian traffic	√	√	√	√	√	√	√
Lift truck traffic	√	√	√	√	√	√	√
Forklift traffic	-	√	√	√	√	√	√
Heavy forklift traffic	-	-	-	-	-	-	√
Material	Soft-PVC	PVC-Film	PVC-Film	PVC-Film	Polyurethan	Polyurethan	PVC-Film
Thickness (mm)	0,16	0,48	0,48	0,48	2,8 ± 0,5 mm	1,6 ± 0,1	1,3
Surface	Matt	Slightly shiny	Slightly shiny	Matt	Matt, reflective	Retro-reflective	Slightly shiny
Slip class	-	-	-	-	Slip inhibition	R12 (DIN EN 16165)	-
Adhesive	Rubber	Modified Acrylate	Acrylate	Acrylate	Synthetic rubber	Synthetic rubber	Modified Acrylate
Adhesive strength	1,5 N/cm	13,6 N/cm	10,8 N/cm	13,6 N/cm	27 N/cm	27,4 N/cm	21,2 N/cm
Temperature range	-20 °C to +120 °C	-20 °C to +70 °C	-40 °C to +60 °C	-20 °C to +70 °C	-20 °C to +70 °C	-20 °C to +70 °C	-20 °C to +70 °C
Processing temperature	≥ 12 °C	18 to 25 °C	to -10 °C	18 to 25 °C	≥ 12 °C	≥ 20 °C	18 to 25 °C
Available lengths (m)	33	50	50	50	12,5	12,5	25
Available widths (mm)	50/75	50/75/100	50/75/100	50/75	50/75/100	50/75/100	50





LONGLIFE FLOOR MARKING TAPE LOW DUTY

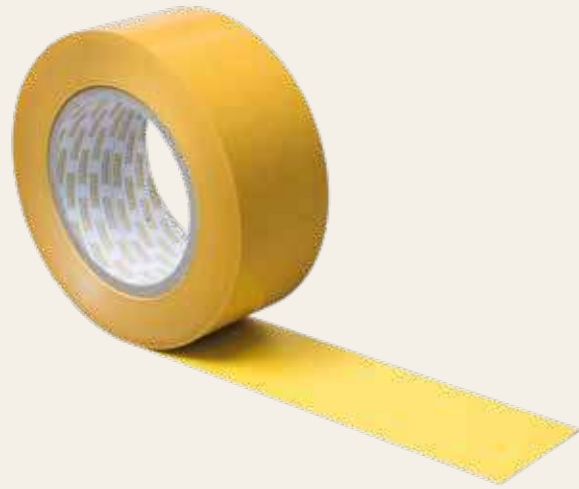

Indicate potential danger zones!

Show your employees the way: with our LongLife LD PVC tape! This has been specially developed to demarcate dangerous zones and warn of unsafe areas. It is intended for temporary use and is perfect for areas where the floor is subject to little strain. The tape is firm and resistant to simple abrasion. It also adapts to a wide variety of materials and surfaces – including concrete, MMA coatings and tiles. The LongLife LD can be used for both indoor and protected outdoor areas. Create clear structures for more safety!

- Suitable for smooth floors
- For indoor and protected outdoor areas
- Resistance to abrasion, decomposition and moisture
- Firm texture
- Adapts to surfaces
- Creates security



LongLife Floor Marking Tape Low Duty								
Version	Format (Width) (mm)	Order no.	+ Colour code				Rolls/pack, roll length	
			■	■	■	■		
Floor marking tape	50	LGLD50-	01	02	04	05	06 07 08 - -	3 x 33 m
Floor marking tape	50	LGLD50-	-	-	-	-	- - SG RW	3 x 33 m
Floor marking tape	75	LGLD75-	01	02	04	05	06 07 08 - -	2 x 33 m
Floor marking tape	75	LGLD75-	-	-	-	-	- - SG RW	2 x 33 m





LONGLIFE FLOOR MARKING TAPE



A product made of high-quality plastic in combination with a high-performance adhesive.

- Simple attachment
- Forklift proof
- High abrasion resistance
- Excellent adhesion
- Scratch-resistant material
- Delivered on a roll in a dispenser box

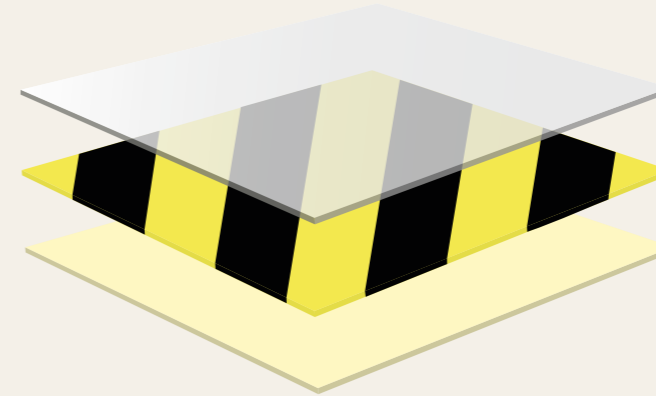

LongLife Floor Marking Tape

Version	Format (Width) (mm)	Order no.	+ Colour code													Roll length/ Pack	
			01	02	03	04	05	06	07	08	88	SG	BW	GW	RW		SW
Floor marking tape	50	LG50-	01	02	03	04	05	06	07	08	88	SG	BW	GW	RW	SW	50 m
Floor marking tape	75	LG75-	01	02	03	04	05	06	07	08	88	SG	BW	GW	RW	SW	50 m
Floor marking tape	100	LG100-	01	02	03	04	05	06	07	08	88	SG	-	-	-	-	50 m
Floor marking tape ESD Protected Area	50	LG50-ESD	-	-	-	-	-	-	-	-	-	-	-	-	-	-	50 m
Floor marking tape ESD Protected Area	75	LG75-ESD	-	-	-	-	-	-	-	-	-	-	-	-	-	-	50 m
45°-Degree Angle	50	LG-50-W45-	01	02	03	04	05	06	07	08	88	-	-	-	-	-	50 Pcs.
45°-Degree Angle	75	LG-75-W45-	01	02	03	04	05	06	07	08	88	-	-	-	-	-	50 Pcs.
45°-Degree Angle	100	LG-100-W45-	01	02	03	04	05	06	07	08	88	-	-	-	-	-	50 Pcs.
90°-Degree Angle	50	LG-50-W90-	01	02	03	04	05	06	07	08	88	-	-	-	-	-	50 Pcs.
90°-Degree Angle	75	LG-75-W90-	01	02	03	04	05	06	07	08	88	-	-	-	-	-	50 Pcs.
90°-Degree Angle	100	LG-100-W90-	01	02	03	04	05	06	07	08	88	-	-	-	-	-	50 Pcs.





LONGLIFE FLOOR MARKING TAPE INDIVIDUAL



Colour back-printed floor markings in reliable LongLife quality.

- Simple attachment
- Forklift proof
- High abrasion resistance
- Excellent adhesion
- Scratch-resistant material

LongLife Floor Marking Tape Individual

Version	Format (Width) (mm)	Order no.	Roll length
Floor Marking Tape Individual	50	LG50-IND	On request
Floor Marking Tape Individual	75	LG75-IND	On request
Floor Marking Tape Individual	100	LG100-IND	On request





LONGLIFE FLOOR MARKING TAPE FTS

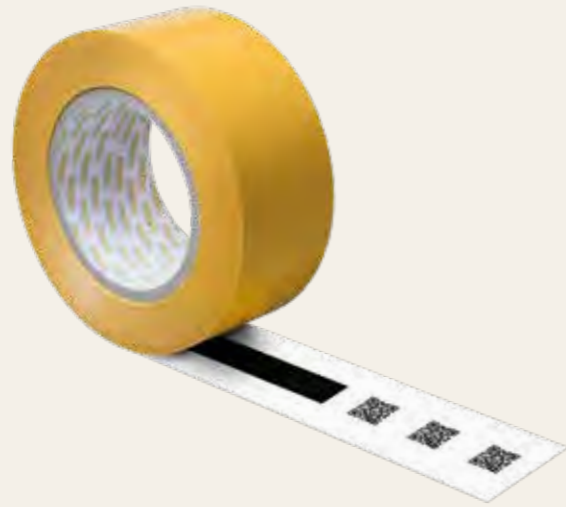

Optical guidance for automated guided vehicles (AGVs)

Always on the right track: With our self-adhesive tape your driverless transport systems are guaranteed to find the right way. Stick a variety of route elements onto smooth indoor floors: lines, curves, forks and even crossings are possible. The surface of the marking tape is particularly resistant to wear and tear, so that the guidance system continues to function perfectly even after a long period of use.

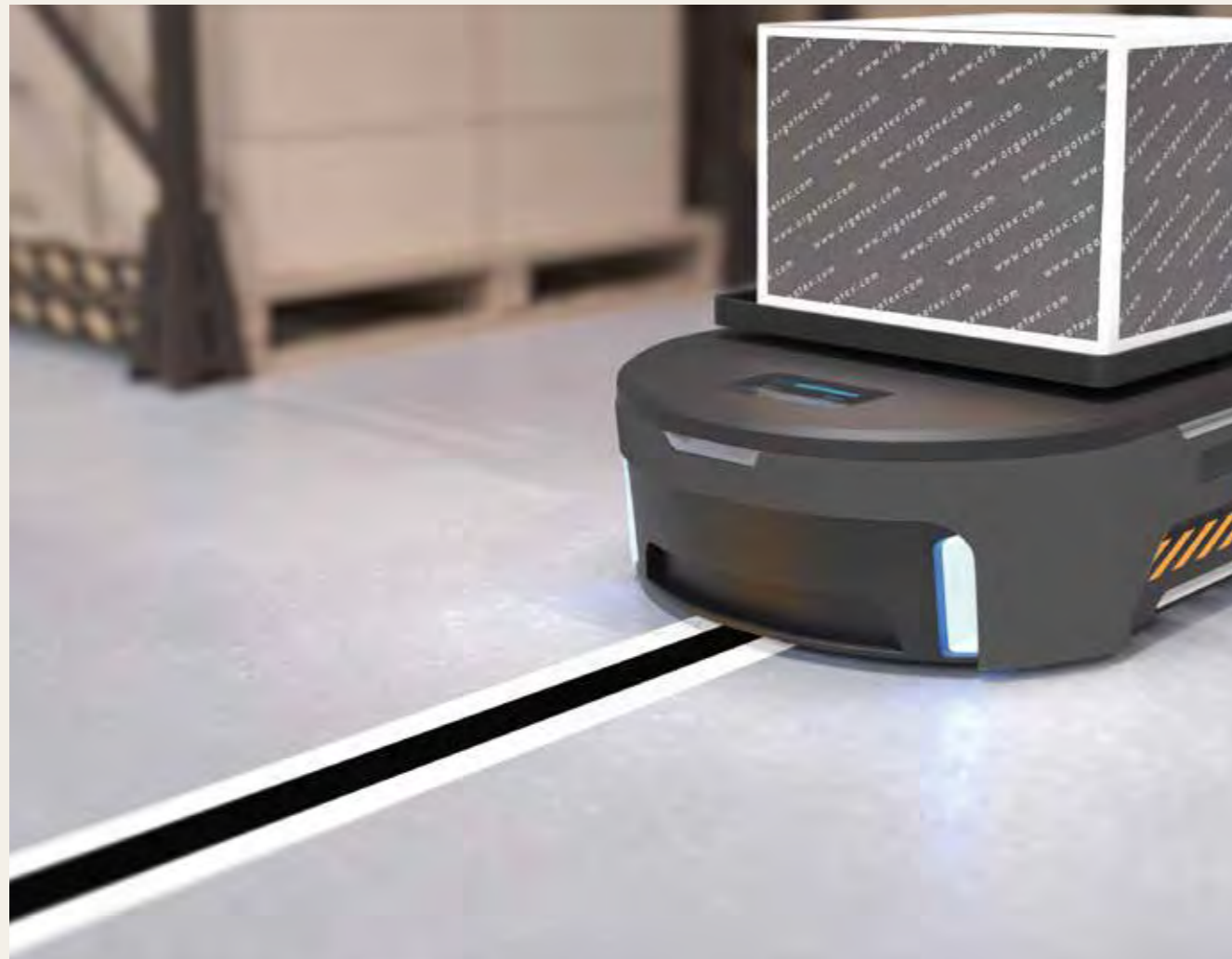

LONGLIFE FLOOR MARKING TAPE FTS

Plan your route using the following elements:

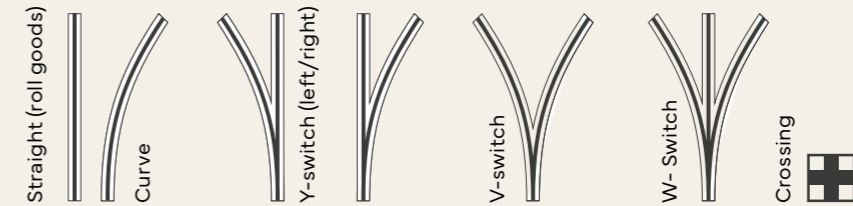

Extra tip: Whether it is special elements, the choice of colours or integrated QR and barcodes – we are also happy to produce the routes individually according to your wishes.

- Glue networks individually
- Little wear and tear with high loads
- Excellent traction
- Special elements possible, e.g. QR codes

LongLife Floor Marking Tape FTS

Version	Order no.
Straight	LGFTS
Curve	LGFTS-KURVE
Switch Y left	LGFTS-WEICHE-Y-L
Switch Y right	LGFTS-WEICHE-Y-R
Switch V	LGFTS-WEICHE-V
Switch W	LGFTS-WEICHE-W
Crossing	LGFTS-KREUZUNG

We manufacture markings according to your specifications and requirements. Let us know!

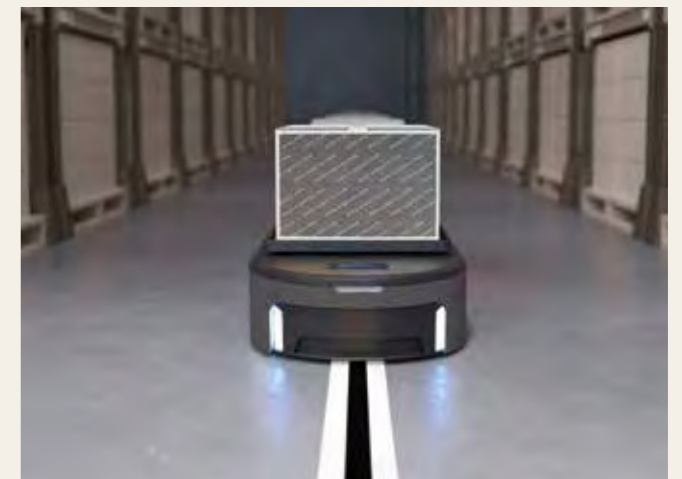



LONGLIFE FLOOR MARKING TAPE GRIP



Durable floor marking

Save yourself the effort of marking floors with real paint! With the LongLife-Grip with anti-slip effect, you can create hard-wearing floor markings easily and quickly. The non-slip and retroreflective surface is suitable for indoor areas and sticks quickly. The extra-strong tape also adheres to surfaces such as concrete, tiles and asphalt. Thanks to its permanent adhesion, it can also be driven over, making it a safe solution for use in your storage area. Mark cleverly and immediately!

- Suitable for smooth and textured floors
- For indoor areas
- Hardwearing and self-adhesive
- Non-slip and retroreflective
- Simple bonding
- Wear resistant
- Suitable for various surfaces
- Immediately accessible



LongLife Floor Marking Tape Grip

Version	Format (Width) (mm)	Order no.	+ Colour code	Roll length (m)
Floor marking tape	50	LGGRIP50-	01 02 04 05 06 07 SG	25
Floor marking tape	75	LGGRIP75-	01 02 04 05 06 07 SG	25
Floor marking tape	100	LGGRIP100-	01 02 04 05 06 07 SG	25



LONGLIFE FLOOR MARKING TAPE HEAVY DUTY



Strong hold for high loads

Long-lasting, even on heavily used surfaces: LongLife HD is our marking tape with a high adhesive strength that can withstand even very heavy loads. Do you want to apply markings where, for example, load carriers or industrial trucks drive across the taped surfaces with heavy weights at high frequency? Then LongLife HD is the right product for you! Extra clever: the milled edge of the tape ensures that even transverse loads, e.g. from forklift trucks, are absorbed particularly well.

- Lasts a long time on heavily used surfaces
- High adhesive strength, low abrasion
- Milled edge against lateral forces



LongLife Floor Marking Tape Heavy Duty

Version	Format (Width) (mm)	Order no.	+ Colour code	Roll length (m)
Floor marking tape	50	LGHD50-	01 02 04 05 07	25



LONGLIFE FLOOR MARKING TAPE OUTDOOR



The best solution for outdoors

LongLife Outdoor is a floor marking tape for outdoor use. Its high material strength and strong synthetic rubber adhesive ensure durability under demanding conditions. The tactile surface offers good grip even when wet. Due to the nature of the adhesive, the tape can be used on both rough and uneven surfaces.

The product is used to mark driveways and footpaths, e.g. in loading areas or outdoor warehouses, as well as for marking potential danger points on loading ramps, such as the edge of the ramp. To increase the adhesive strength, we recommend combining it with LongLife Primer. Indoor applications on uneven surfaces are also possible.

- Non-slip and non-slip surface, even in wet conditions
- Suitable for rough and uneven surfaces
- High adhesive strength, extremely wear-resistant
- For outdoor use in conjunction with the LongLife Primer

LongLife Floor Marking Tape Outdoor				
Version	Format (Width) (mm)	Order no.	+ Colour code	Roll length (m)
Floor marking tape	50	LGOD50-	02 04	12,5
Floor marking tape	75	LGOD75-	02 04	12,5
Floor marking tape	100	LGOD100-	02 04	12,5

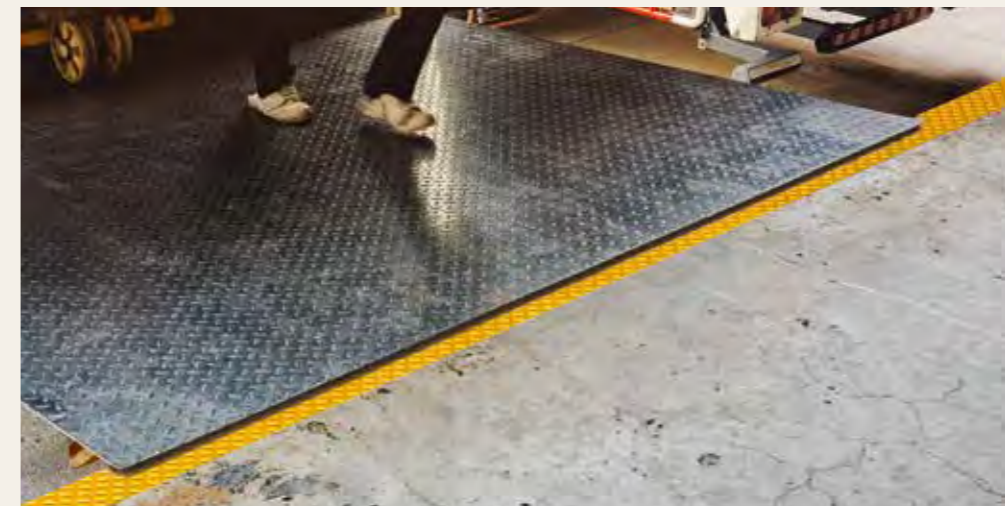
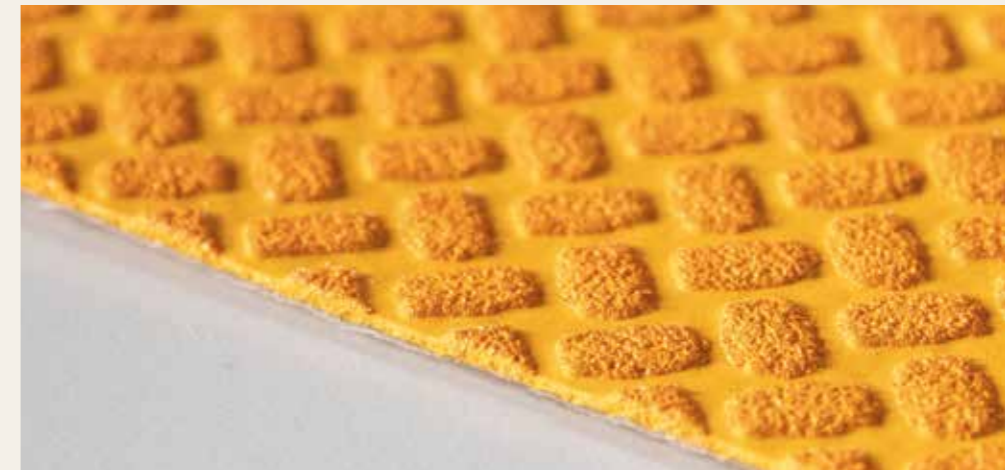



eOX-SPOT



Modern LED tool for a safe working environment

Stop dangerous situations using the Light projector for warning signals: The eOX spotlight with integrated power supply unit can not only be fitted with standard safety and warning signals, it can also be used in a variety of ways with customised motifs. Regardless of the nature of the ground, the swivelling projector with an efficiency of 27 or 56 lm/W projects the required sign onto the desired spot. This avoids hazards such as tripping or abrasion.



Revive your marketing activities!

In addition to its function as an indispensable security tool, you can also use the powerful projector (40 or 80 W) for eye-catching marketing. Your company logo, for example, will be a real eye-catcher!

Advantages at a glance:

- Simple assembly
- High-power LED with 40 W | 80 W
- Easily interchangeable motifs
- Versatile use
- Integrated power supply unit for 230 V
- High energy efficiency
- No wear and tear

eOX-Spot

Order no.

eOX-Spot-40

eOX-Spot-80

Technical Data eOX-Spot

Item number	eOX-Spot-40 eOX-Spot-80
Housing material	Steel/aluminium, powder-coated
Weight	1,97 kg 3,5 kg
IEC socket	On the back of the device
Field of application	Dry interiors
Field of application	-30 °C to +35 °C
Cooling	Active cooling/fan
Noise level	20 dB(A) 29 dB(A)
Light source	40 W 80 W high-power LED
Average service life of the LED	35.000 hours
Colour temperature	6300 – 6700 K
Luminous flux of the projector	1150 lm 4730 lm
Efficiency	27 lm/W 56 lm/W
Motif size/image size	37,5 mm/20 mm 50 mm/40 mm
Input voltage	220 – 240 V AC, 50/60 Hz
Power consumption	42 W 84 W
Protection class/protection type of the housing	I/IP20
Photobiological safety	RG-2 (according to ICE62471-5:2015, EN62471-5:2015)

MOTIF EXCHANGEABLE

OBJECTIVE FOCUS ADJUSTMENT

COLD APPLIANCE SOCKET POWER CONSUMPTION: 42 W | 84 W

MOTIF HOLDER SCREW-MOUNTABLE





eOX-SPOT STANDARDMOTIFS 40 W AND 80 W



Forklift prohibited

Order no.:
EOX-SPOT-M-1
EOX-SPOT-80-M-1



No pedestrian access

Order no.:
EOX-SPOT-M-2
EOX-SPOT-80-M-2



Caution forklift truck area

Order no.:
EOX-SPOT-M-3
EOX-SPOT-80-M-3



Pedestrian route

Order no.:
EOX-SPOT-M-4
EOX-SPOT-80-M-4



Black & White
(motif without colour)

Order no.:
EOX-SPOT-MI-SW
EOX-SPOT-80-MI-SW



1 Colour
(motif singlecoloured)

Order no.:
EOX-SPOT-MI-1
EOX-SPOT-80-MI-1



2 Colours
(two-coloured motif)

Order no.:
EOX-SPOT-MI-2
EOX-SPOT-80-MI-2



3 Colours
(three-coloured motif)

Order no.:
EOX-SPOT-MI-3
EOX-SPOT-80-MI-3



Stop and give way!

Order no.:
EOX-SPOT-M-9
EOX-SPOT-80-M-9



No trespassing

Order no.:
EOX-SPOT-M-17
EOX-SPOT-80-M-17



Caution forklift truck area

Order no.:
EOX-SPOT-M-101
EOX-SPOT-80-M-101



4 Colours
(four-coloured motif)

Order no.:
EOX-SPOT-MI-4
EOX-SPOT-80-MI-4



Forklift traffic, no access, pedestrians and much more: Warning and information signs are regularly required in the manufacturing industry and in many other sectors. You will find ready-made motifs for standard situations in our range. Customised motifs are also possible.



LOGLIFE SYMBOLS

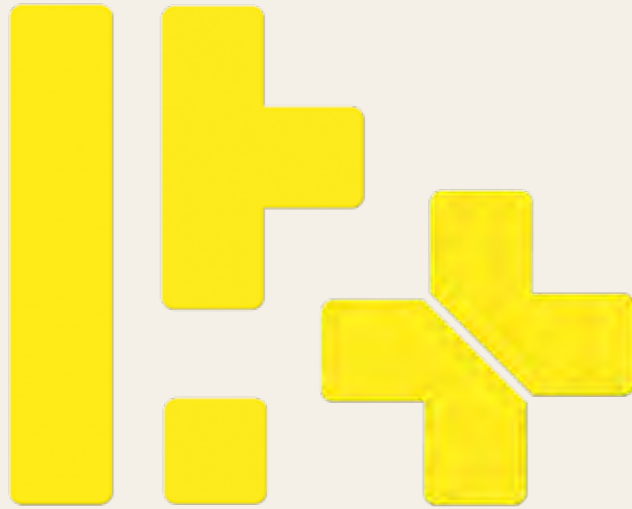

Available in 9 standard colours and in various widths for marking storage areas, parking spaces, transport routes, etc. Depending on the task, we recommend the use of:

- Longitudinal markings
- T-pieces
- L-angles/crosses
- Squares

LongLife Symbols												
Version	Format (WxL) (mm)	Order no.	+ Colour code						Pack			
			01	02	03	04	05	06		07	08	88
T-Pcs.	50	LG-50-T-	01	02	03	04	05	06	07	08	88	50 Pcs.
T-Pcs.	75	LG-75-T-	01	02	03	04	05	06	07	08	88	50 Pcs.
L-Angle	50	LG-50-L-	01	02	03	04	05	06	07	08	88	50 Pcs.
L-Angle	75	LG-75-L-	01	02	03	04	05	06	07	08	88	50 Pcs.
Longitudinal m.	50 x 250	LG-50250-	01	02	03	04	05	06	07	08	88	50 Pcs.
Longitudinal m.	75 x 350	LG-75350-	01	02	03	04	05	06	07	08	88	50 Pcs.
Longitudinal m.	100 x 500	LG-100500-	01	02	03	04	05	06	07	08	88	50 Pcs.
Square	50	LG-50-Q-	01	02	03	04	05	06	07	08	88	50 Pcs.
Square	75	LG-75-Q-	01	02	03	04	05	06	07	08	88	50 Pcs.
Square	100	LG-100-Q-	01	02	03	04	05	06	07	08	88	50 Pcs.





LONGLIFE SYMBOLS ROUNDED

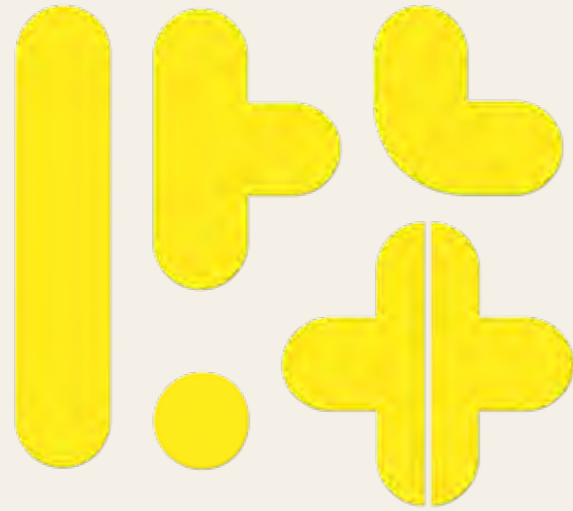

Available in 9 standard colours for marking storage areas, parking spaces, transport routes, etc. Depending on the use we recommend:

- Longitudinal markings
- T-pieces
- L-angles
- Dots
- Crosses

Longlife Symbols Rounded						
Version	Format (WxL) (mm)	Order no.	+ Colour code	Pack		
T-Pcs.	90	LGR-90-T-	01 02 03 04 05 06 07 08 88	50 Pcs.		
L-Angle	90	LGR-90-L-	01 02 03 04 05 06 07 08 88	50 Pcs.		
Longitudinal m.	90 x 450	LGR-90450-	01 02 03 04 05 06 07 08 88	50 Pcs.		
Dots	90	LGR-90-P-	01 02 03 04 05 06 07 08 88	50 Pcs.		
Cross (2 Parts)	90	LGR-90-K-	01 02 03 04 05 06 07 08 88	50 Pcs.		





LONGLIFE SYMBOLS FOOT AND ARROW



Available in 9 standard colours for marking walkways.

- Simple attachment
- Forklift-proof
- High abrasion resistance
- Excellent adhesion
- Pointing the way



LongLife Symbols Foot and Arrow

Version	Format (WxL) (mm)	Order no.	+ Colour code									Pack
			01	02	03	04	05	06	07	08	88	
Foot	90 x 280	LGSTP-	01	02	03	04	05	06	07	08	88	50 Pcs.
Arrow	100 x 175	LGPF-	01	02	03	04	05	06	07	08	88	50 Pcs.

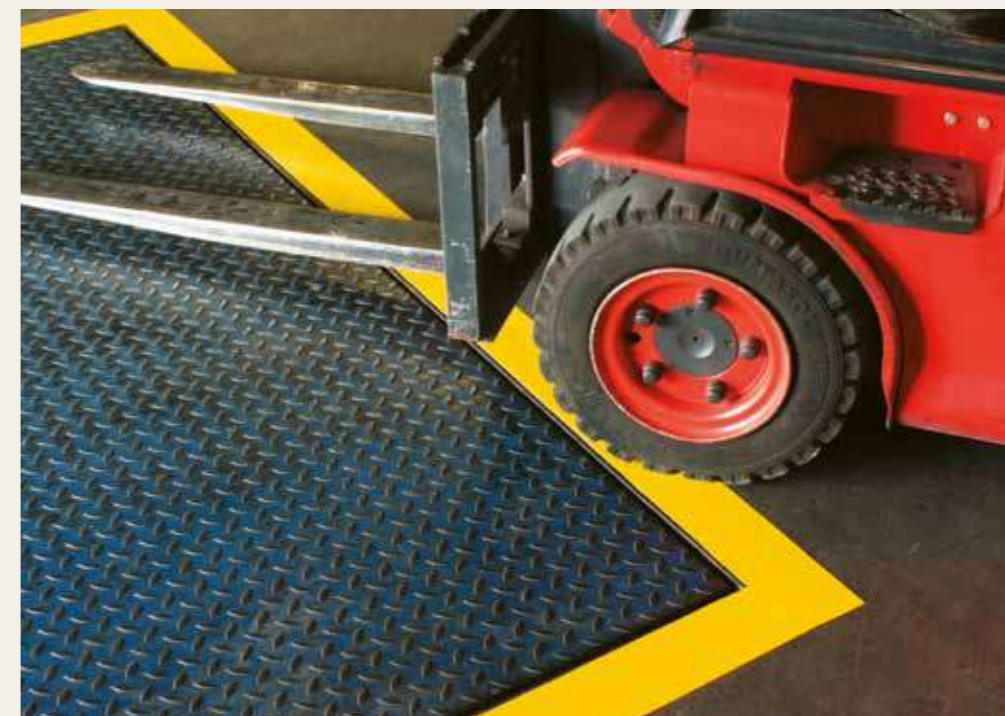



LONGLIFE SYMBOLS HEAVY DUTY



Our LongLife Heavy Duty floor marking is suitable for marking e.g. driveways and parking spaces that are subject to extreme strain. The combination of high-quality material and bevelled edge offers the optimum combination of strength and function.

- Excellent adhesion
- Extremely robust
- Forklift-proof

Longlife Symbols Heavy Duty

Version	Format (WxL) (mm)	Order no.	+ Colour code								Pack
			01	02	03	04	05	06	07	08	
T-Pcs.	50	LGHD-50-T-	01	02	03	04	05	06	07	08	20 Pcs.
L-Angle	50	LGHD-50-L-	01	02	03	04	05	06	07	08	20 Pcs.
Longitudinal m.	50 x 250	LGHD-50250-	01	02	03	04	05	06	07	08	20 Pcs.





LONGLIFE SYMBOLS HEAVY DUTY ROUNDED



Our LongLife Heavy Duty Rounded floor markings are suitable for marking driveways and parking spaces, for example, which are subject to extreme strain. The combination of high-quality material and bevelled edge offers the optimum combination of strength and function.

- Excellent adhesion
- Extremely robust
- Forklift-proof



LongLife Symbols Heavy Duty Rounded

Version	Format (WxL) (mm)	Order no.	+ Colour code								Pack
			01	02	03	04	05	06	07	08	
T-Pcs.	90	LGRHD-90-T-	01	02	03	04	05	06	07	08	20 Pcs.
L-Angle	90	LGRHD-90-L-	01	02	03	04	05	06	07	08	20 Pcs.
Dot	90	LGRHD-90-P-	01	02	03	04	05	06	07	08	20 Pcs.
Longitudinal m.	90 x 450	LGRHD-90450-	01	02	03	04	05	06	07	08	20 Pcs.





LONGLIFE MODULE



Extremely robust marking panels for block storage and other heavy-duty areas. LongLife Module, with its special adhesive, it is made from high-quality, break-proof plastic and is therefore extremely resilient.

- Extremely robust
- Scratch resistant
- Self-adhesive and optionally with additional perforation for impact dowels (6 x 40 mm)

LongLife Module											
Version	Format (WxL) (mm)	Order no.	+ Colour code								Pack
			01	02	03	04	05	06	07	08	
Square	75 x 75	LGMOD-SK-	01	02	03	04	05	06	07	08	50 Pcs.
Square with perforation	75 x 75	LGMOD-ND-	01	02	03	04	05	06	07	08	50 Pcs.
Impact dowel	6 x 40	LG6X40ND									50 Pcs.

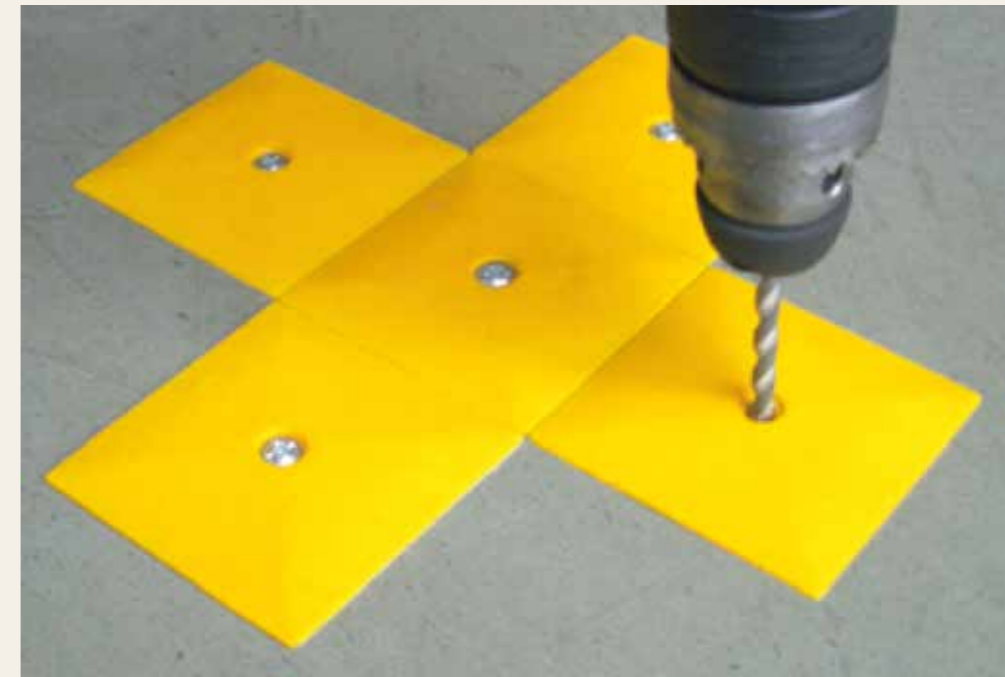



LONGLIFE MODULE L-ANGLE



The robust labelling symbol is used especially for extreme loads.

- For indoor and outdoor use
- Extremely robust
- Easy to install, even on uneven or oily floors
- Forklift-proof
- Scratch resistant
- Incl. mounting material



LongLife Module L-Angle

Version	Format (Width) (mm)	Order no.	+ Colour code	Pack
L-Angle	50	LGMOD-L-	01 02 03 04 05 07 08	20 Pcs.





LONGLIFE CLEAR VIEW



Available in 9 standard colours and in different sizes for marking storage areas, parking spaces, etc

- Simple attachment
- Clear identification through colouring
- Excellent adhesion strength due to wide adhesive surfaces
- High abrasion resistance
- Scratch-resistant material



LongLife Clear view

Version	Format (WxH) (mm)/(in)	Order no.	+ Colour code									Pack
			01	02	03	04	05	06	08	HB	88	
DIN A4	400 x 310	LG-KL-A4-	01	02	03	04	05	06	08	HB	88	10 Pcs.
1/2 DIN A4	400 x 205	LG-KL-1/2A4-	01	02	03	04	05	06	08	HB	88	10 Pcs.
DIN A5	310 x 250	LG-KL-A5-	01	02	03	04	05	06	08	HB	88	10 Pcs.
1/3 DIN	310 x 200	LG-KL-1/3DIN-	01	02	03	04	05	06	08	HB	88	10 Pcs.
LETTER	15,1 x 12,6	LG-KL-216X279-	01	02	03	04	05	06	08	HB	88	10 Pcs.
1/2 LETTER – portr.	15,10 x 8,30	LG-KL-108X279-	01	02	03	04	05	06	08	HB	88	10 Pcs.
1/2 LETTER – landsc.	12,60 x 9,70	LG-KL-216X139-	01	02	03	04	05	06	08	HB	88	10 Pcs.
1/3 LETTER – landsc.	12,60 x 7,70	LG-KL-216X93-	01	02	03	04	05	06	08	HB	88	10 Pcs.



Available in 9 standard colours for labelling storage areas, parking spaces, etc.

- Simple attachment
- Clear identification through colouring
- Excellent adhesive strength due to wide adhesive surfaces
- High abrasion resistance
- Scratch-resistant material

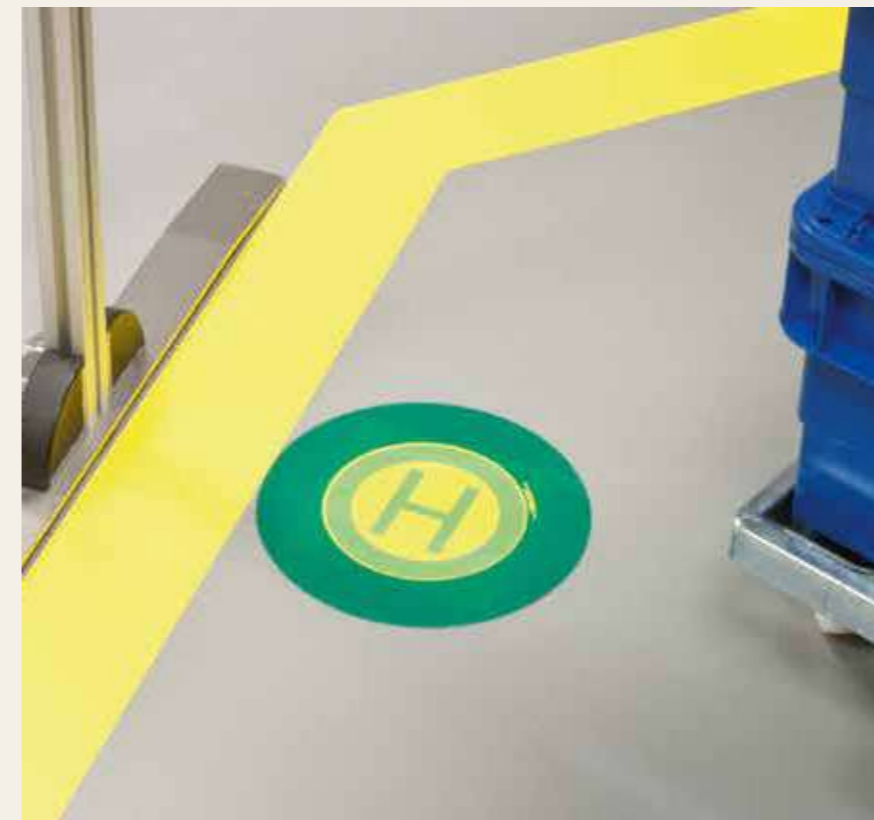

LongLife Clear view

Version	Format (W x H / Ø) (mm)	Order no.	+ Colour code									Für Vouchers/ ET	Pack
			01	02	03	04	05	06	08	HB	88		
Circle	210	LG-KL-KREIS-	01	02	03	04	05	06	08	HB	88	ET136	10 Pcs.
Arrow	320 x 100	LG-KL-PFEIL-	01	02	03	04	05	06	08	HB	88	290 x 45 mm	10 Pcs.
Cardboard insert, white	136 x 136	ET136											10 Pcs.
Cardboard insert, printed	136 x 136	ET136-HALTESTELLE											5 Pcs.



SET FOR PARKING SPACE MARKING

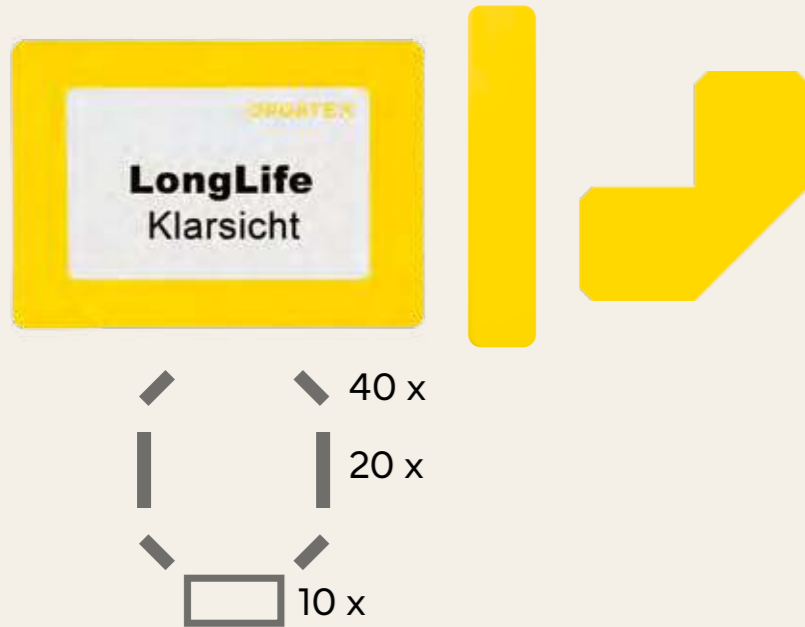

The labelling of storage locations is crucial for structuring the internal flow of goods and warehousing. Avoid long search times and enable your employees to precisely allocate materials to the appropriate storage locations. We have put together the most important components for you in a set, combining our top sellers.

The L-brackets and longitudinal markings in 50 mm width and the transparent windows in A4 format enable clear labelling of the pallet storage space. The set is designed for 10 storage spaces. Transparent fixing points also make it easier to attach the window. The document on the floor does not slip.

- Simplified ordering process
- Fixing points for the slip
- Common 5S colours
- Other widths and DIN formats on request
- With fixing points for easy application

Set for parking space marking

Version	Width (mm)	Order no.	+ Colour code
Parking space marking	50	LG50-SP-	01 02 03 04 05 06 08 88





LOGLIFE COLD PERFORMANCE

Our new LongLife Cold Performance floor marking is suitable for labelling driveways, parking spaces, danger zones or escape routes. It was developed specifically for industrial areas with extremely low ambient temperatures.

- Bonding temperature down to -20 °C
- High adhesive and holding power in cold areas
- Simple attachment
- High resistance
- 5S projects in deep-freeze areas
- Available in various colours and designs

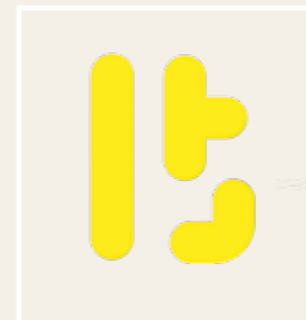
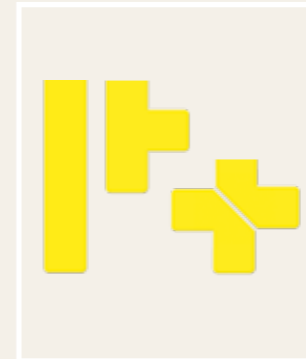

LongLife Cold Performance Floor Marking Tapes

Version	Format (mm)	Order no.	+ Colour code								Roll	
			01	02	03	04	05	06	07	08		
Floor Marking Tape	50 mm	LGCP50-	01	02	03	04	05	06	07	08	88	50 m
Floor Marking Tape	75 mm	LGCP75-	01	02	03	04	05	06	07	08	88	50 m
Floor Marking Tape	100 mm	LGCP100-	01	02	03	04	05	06	07	08	88	50 m

LongLife Cold Performance Symbols

Version	Format (mm)	Order no.	+ Colour code								Pack	
			01	02	03	04	05	06	07	08		
T-Pcs.	50	LGCP-50-T-	01	02	03	04	05	06	07	08	88	50 Pcs.
L-Angle	50	LGCP-50-L-	01	02	03	04	05	06	07	08	88	50 Pcs.
Longitudinal m.	50 x 250	LGCP-50250-	01	02	03	04	05	06	07	08	88	50 Pcs.
T-Pcs.	75	LGCP-75-T-	01	02	03	04	05	06	07	08	88	50 Pcs.
L-Angle	75	LGCP-75-L-	01	02	03	04	05	06	07	08	88	50 Pcs.
Longitudinal m.	75 x 350	LGCP-75350-	01	02	03	04	05	06	07	08	88	50 Pcs.

LongLife Cold Performance Clear view

Version	Format (mm)	Order no.	+ Colour code								Pack	
			01	02	03	04	05	06	08	88		
DIN A4	400 x 310	LGCP-KL-A4-	01	02	03	04	05	06	08	88	HB	10 Pcs.
1/2 DIN A4	400 x 205	LGCP-KL-1/2A4-	01	02	03	04	05	06	08	88	HB	10 Pcs.
DIN A5	310 x 250	LGCP-KL-A5-	01	02	03	04	05	06	08	88	HB	10 Pcs.
1/3 DIN	310 x 200	LGCP-KL-1/3DIN-	01	02	03	04	05	06	08	88	HB	10 Pcs.

LongLife Cold Performance Symbols Rounded

Version	Format (mm)	Order no.	+ Colour code								Pack	
			01	02	03	04	05	06	07	08		
T-Pcs.	90	LGRCP-90-T-	01	02	03	04	05	06	07	08	88	50 Pcs.
L-Angle	90	LGRCP-90-L-	01	02	03	04	05	06	07	08	88	50 Pcs.
Longitudinal m.	90 x 450	LGRCP-90450-	01	02	03	04	05	06	07	08	88	50 Pcs.
Punkt	90	LGRCP-90-P-	01	02	03	04	05	06	07	08	88	50 Pcs.



LONGLIFE REMOVER/CLEANER/ PRIMER/EDGE SEALER

LongLife Remover: When removing old floor markings, adhesive residues often remain on the floor. LongLife Remover is ideal for removing this residue.

LongLife Cleaner: Before applying the floor markings, make sure that the floor is free of dust and oil. We recommend our LongLife Cleaner for precleaning the floors.

LongLife Primer: Primer to increase the adhesive strength on critical surfaces. Always necessary in outdoor areas.

LongLife edge sealing: Sealing prevents the penetration of moisture, e.g. in outdoor areas. 140 ml is sufficient for approx. 10 - 15 m.



LongLife Remover/Cleaner/Primer/edge sealing

Designation	Order no.	VE
LongLife Remover	LG-REMOVER/6	6 x 1 l
LongLife Cleaner	LG-CLEANER/6	6 x 1 l
LongLife Primer	LG-PRIMER	1 l
LongLife edge sealing	LG-VERSIEGELUNG	140 ml





LOGLIFE TRIMMING SYSTEM



Useful tool for cutting ORGATEX® floor markings to length easily and safely. The cut is made in the folded stainless-steel sheet, no slipping due to the good clamping effect.

- Angle: 90°
- Angle: 45°, on both sides
- Finish: Stainless steel
- Suitable for all widths: 50/75/100 mm



LongLife Trimming system

Format (WxL)	Order no.
120 x 250 mm	LG-TS100



LOGLIFE PRESSURE ROLLER



The pressure roller ensures even pressure distribution and is therefore the ideal support when laying markings and signs. The pressing on of anti-slip products and bonding to profiled substrates in particular is simplified.

- Rubber roller
- Roller width: 75 mm

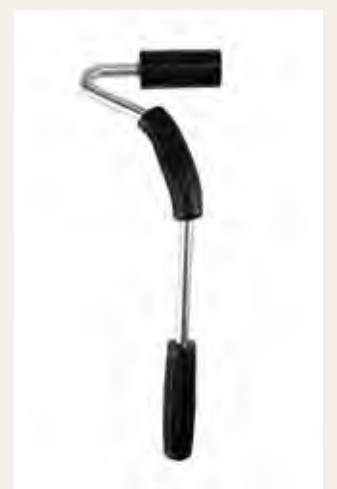
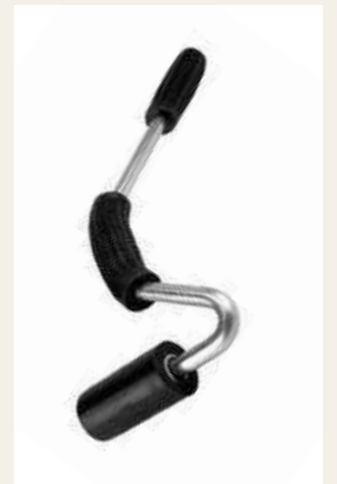
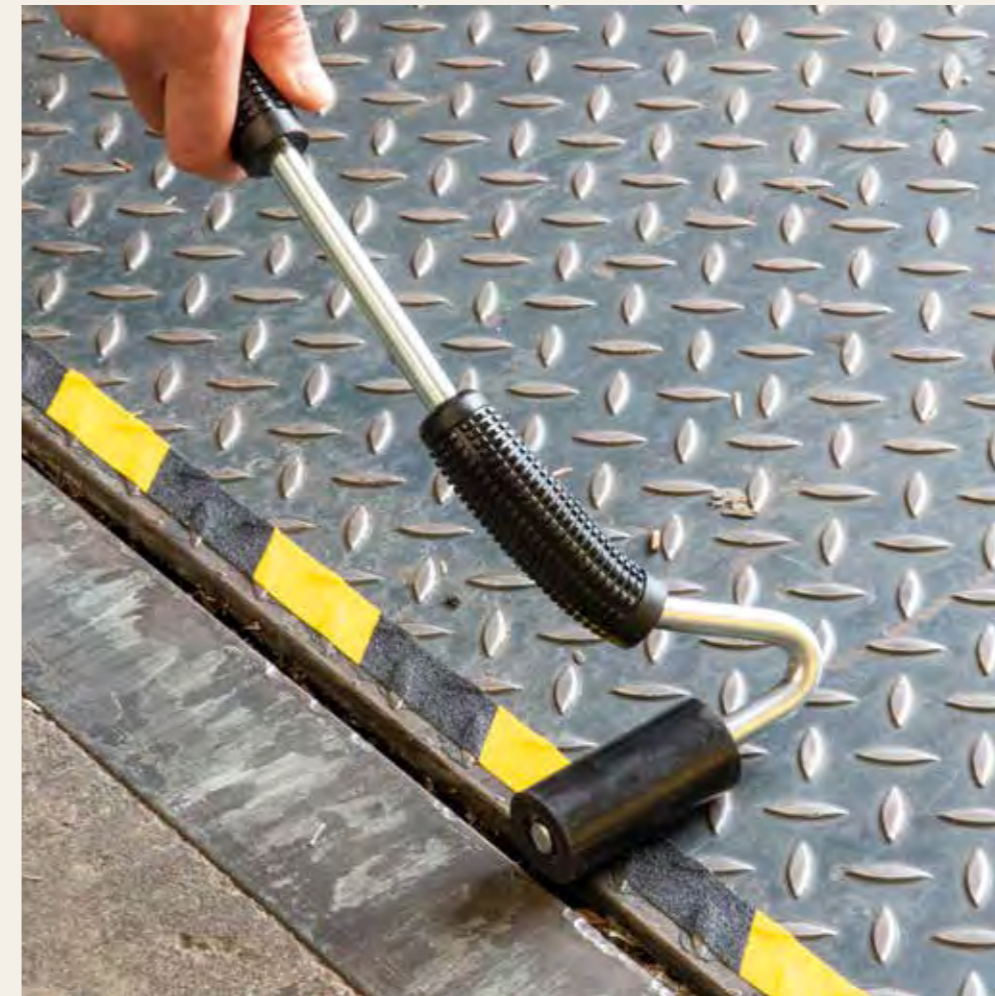

LongLife Pressure roller

Designation	Roller width	Order no.
Pressure roller	75 mm	LG-ANDRUCKROLLER

INSERTION SYSTEMS

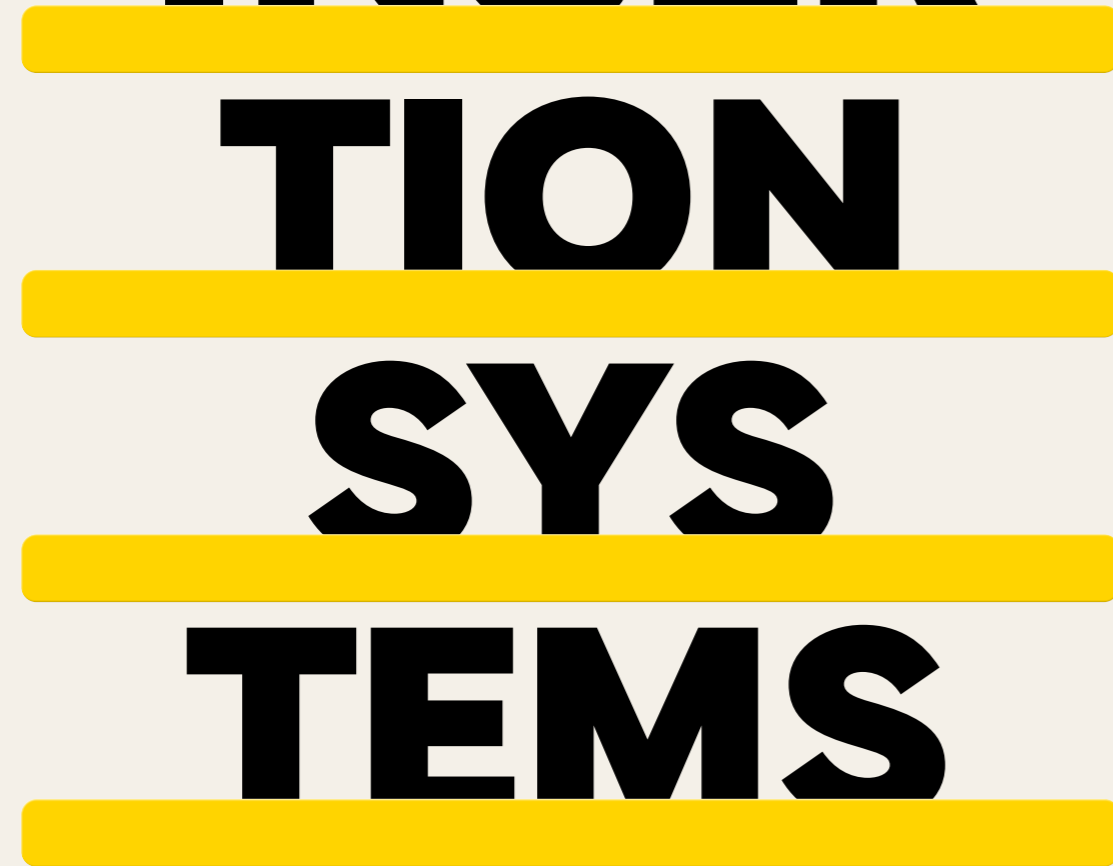

KANBAN is a method for optimising production processes that has become an integral part of modern, lean logistics. It is based on the pull principle, whereby materials are produced or delivered to production according to demand. In practice, this is implemented with the help of KANBAN boards, which work according to the traffic light principle.



Lot-Size-KANBAN	142
Heijunka-Board	143
KANBAN-Starterset	From 144
KANBAN starter sets: variations	146
System box DIN A4	148
System box DIN A4: accessories	149
KANBAN-System box	150
System box: accessories	151
Cardplan® Boards	From 153
Cardplan®: accessories	156
Planning panel stand, suspension rails	158
Desktop document holder	From 160
Desktop document holder: accessories	162
KANBAN-Letterbox, transparent	164
Primus view box	From 166
Primus column or row systems/accessories	168
Primus single compartments	169
Work document sleeve DIN A4	170
Primus workstation bag	171



[katalog.orgatex.com/
plug-in systems](https://katalog.orgatex.com/plug-in-systems)

KANBAN cards from emptied containers are sorted by part number and inserted into the KANBAN board. If the yellow area is reached, the person responsible can decide whether to restock.

When the red zone is reached, production or replenishment must be carried out immediately. ORGATEX® provides you with all the tools you need for production control via KANBAN. Our portfolio includes all individual elements with a comprehensive range of accessories for your specific requirements as well as KANBAN starter sets in various sizes and designs, which you can use to get started straight away.

Of course, we can also manufacture customised KANBAN or lot-size KANBAN boards for you that are precisely tailored to the needs of your business.

Another method in the context of lean production is Heijunka (Japanese term for „levelling“ or „smoothing“). A Heijunka board makes it possible to organise production more evenly and to respond to fluctuations or special features in demand. At ORGATEX® we create these organisation systems individually and tailored to your needs.

INFOGRAPHIC INSERTION SYSTEMS

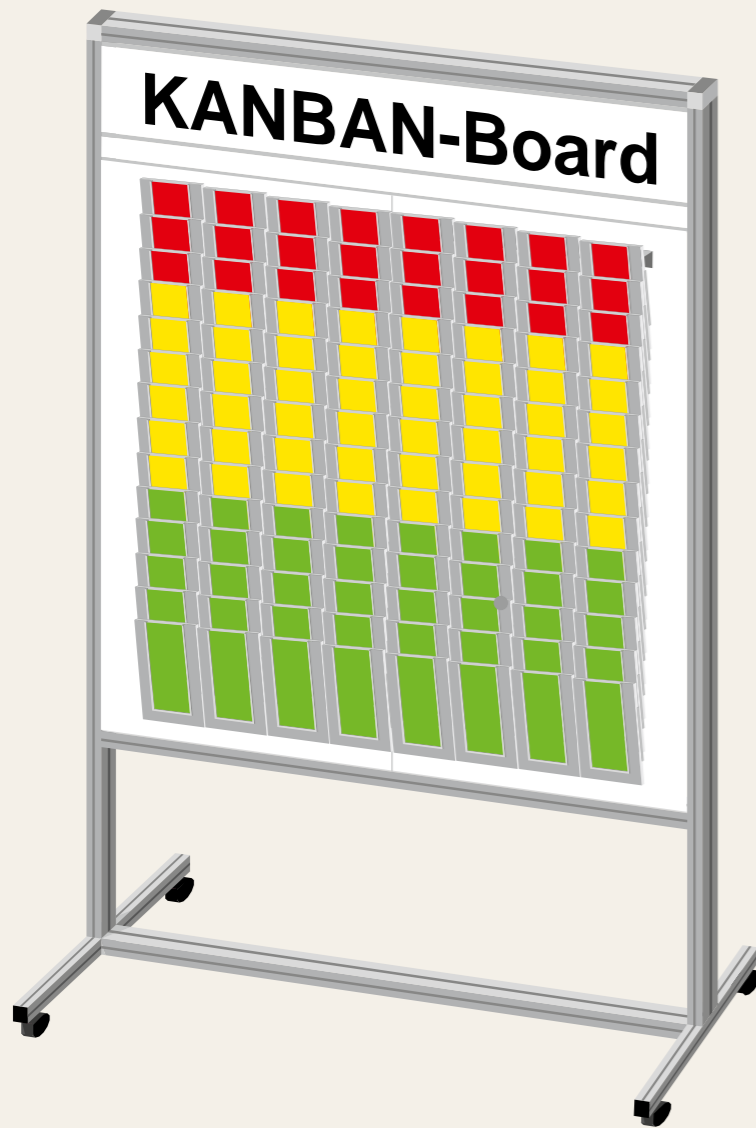

Traffic light KANBAN board (with system boxes)



Fast and simple assembly

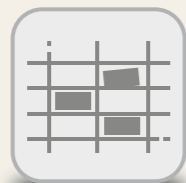

From the KANBAN Card up to the KANBAN Board: We have the right solution.



Customised to the needs of your production

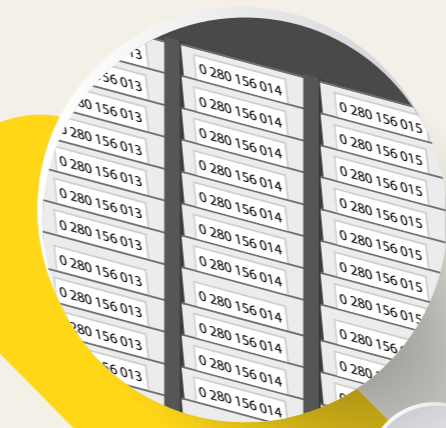
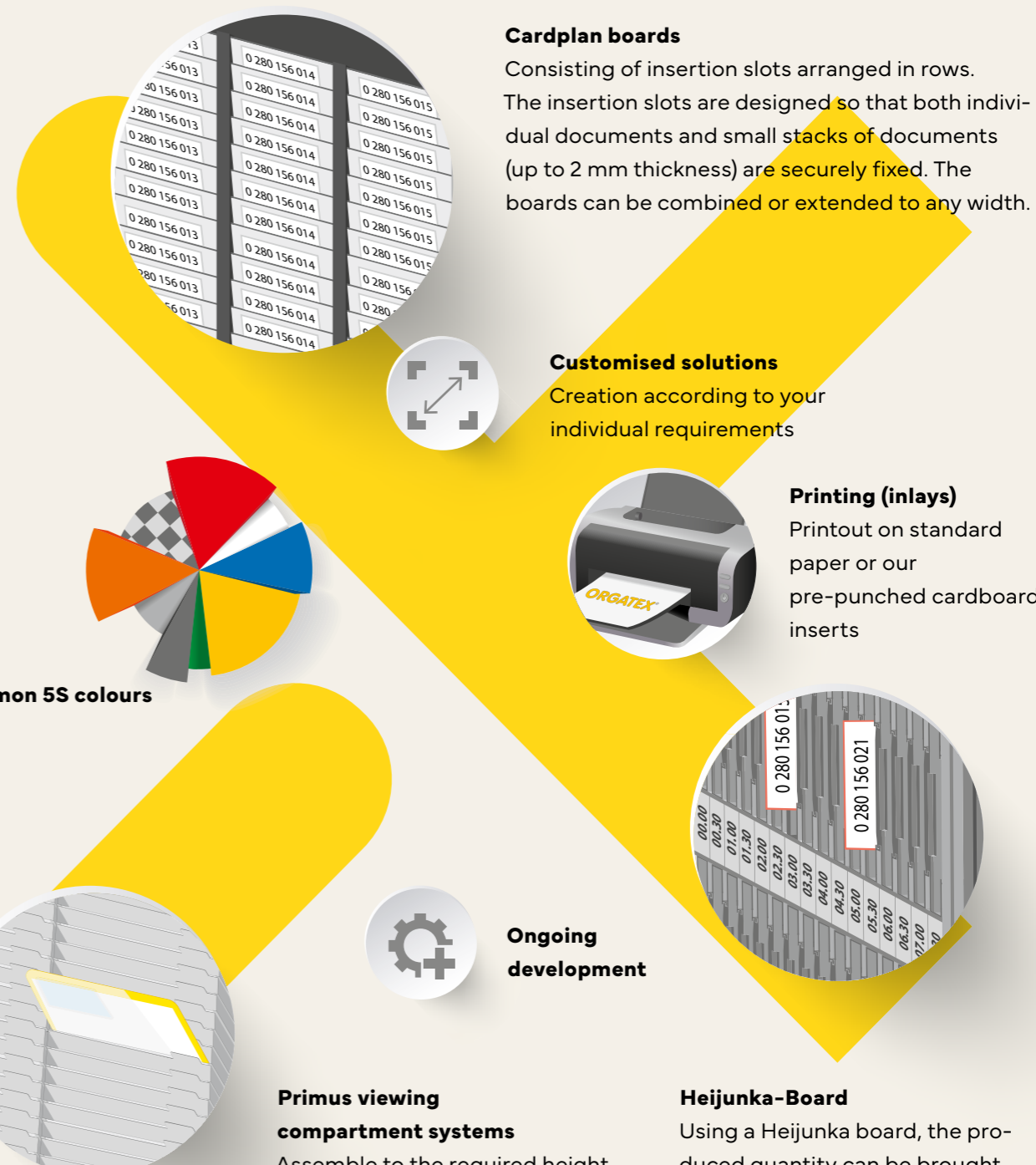

Cardplan boards
Consisting of insertion slots arranged in rows. The insertion slots are designed so that both individual documents and small stacks of documents (up to 2 mm thickness) are securely fixed. The boards can be combined or extended to any width.



Customised solutions
Creation according to your individual requirements



Common 5S colours



Printing (inlays)
Printout on standard paper or our pre-punched cardboard inserts



Ongoing development

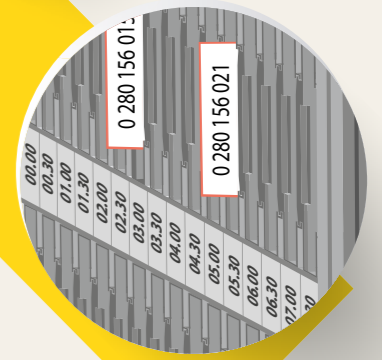

Primus viewing compartment systems
Assemble to the required height and width. Extend or regroup, e.g. form rows of compartments, hang individual compartments, etc. For extensions, simply pull out the end panel and attach further extension elements or arrange them in any desired position. All elements can be regrouped, extended or subdivided vertically or horizontally at any time.

Heijunka-Board
Using a Heijunka board, the produced quantity can be brought into a sequence or a time grid and thus levelled. Each ORGATEX® Heijunka board is created according to your individual specifications. The height, width and individual elements are precisely tailored to you and your production requirements.

LOT-SIZE-KANBAN

The lot-size KANBAN board enables controlling materials according to the pull principle. Previously defined quantities are replenished according to type, which leads to a reduction in material stocks and a smoothing of production processes. ORGATEX® control boards are customised and adapted to the customer's requirements.



HEIJUNKA-BOARD

Fluctuations in demand, for example, lead to ever-increasing order peaks in the processes of the upstream work stages. With the help of the Heijunka board, the customer or internal production orders are produced in a defined (e.g. setup-optimised) sequence and these fluctuations are levelled out and smoothed. This is very often the basis for a stable process.

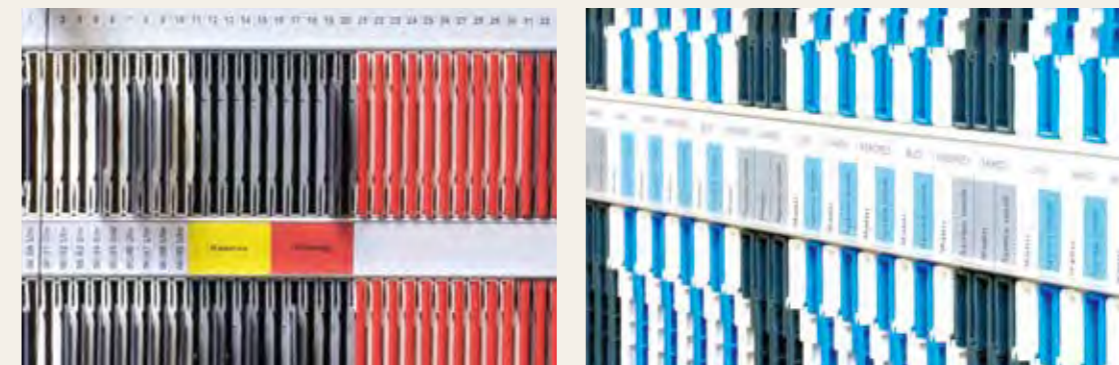

KANBAN-STARTERSET



Our KANBAN starter sets are the result of our many years of experience and represent the most common applications in the industry. They are available in 3 sizes, matched to part numbers and control circuits. You can get started straight away with our starter set. The version with stand on castors is suitable for mobile use, while the wall-mounted version is suitable for stationary use.



KANBAN STARTER SETS: VERSIONS



Starter set M (for up to 200 Cards)				
Contains	Piece	Order no.	Order no. with metal frame on castors	Order no. without metal frame on castors
Metal frame on castors	1	KS129-G	SYSB-Starter-M	SYSB-Starter-M-W
Greyboard, 1085 x 500 mm	2	K531-G		
Greyboard, 1085 x 250 mm	1	K230-G		
System box	200	SYSB-07		
Insert label, small, cardboard inserts ET33-75K	200	SYSB-HE-35		
Insert label, large, cardboard inserts ET33-168K	8	SYSB-HE-169		
Barrier label, cardboard inserts ET33-168K	20	SYSB-HE-35-SPERR		
System box 4-fold Wall bracket	2	SYSB-WH-4		
KANBAN letterbox	1	KAN-SERM116		
Magnetic Windows	1+1	KAN-MW-A4H-04/-05		



Starter set L (for up to 300 Cards)				
Contains	Piece	Order no.	Order no. with metal frame on castors	Order no. without metal frame on castors
Metal frame on castors	1	KS179-G	SYSB-Starter-L	SYSB-Starter-L-W
Greyboard, 1085 x 500 mm	3	K531-G		
Greyboard, 1085 x 250 mm	1	K230-G		
System box	300	SYSB-07		
Insert label, small, cardboard inserts ET33-75K	300	SYSB-HE-35		
Insert label, large, cardboard inserts ET33-168K	12	SYSB-HE-169		
Barrier label, cardboard inserts ET33-168K	30	SYSB-HE-35-SPERR		
System box 4-fold Wall bracket	3	SYSB-WH-4		
KANBAN-Letterbox	1	KAN-SERM116		
Magnetic Windows	1+1	KAN-MW-A4H-04/-05		



Starter set XL (for up to 400 Cards)				
Contains	Piece	Order no.	Order no. with metal frame on castors	Order no. without metal frame on castors
Metal frame on castors	1	KS204-G	SYSB-Starter-XL	SYSB-Starter-XL-W
Greyboard, 1085 x 500 mm	4	K531-G		
Greyboard, 1085 x 250 mm	-	-		
System box	400	SYSB-07		
Insert label, small, Cardboard inserts ET33-75K	400	SYSB-HE-35		
Insert label, large, Cardboard inserts ET33-168K	16	SYSB-HE-169		
Barrier label, Cardboard inserts ET33-168K	40	SYSB-HE-35-SPERR		
System box 4-fold Wall bracket	4	SYSB-WH-4		
KANBAN-Letterbox	-	-		
Magnetic Windows	-	-		



SYSTEM BOX DIN A4



Open compartment system for DIN A4 documents.
Available in 2 versions, depending on the amount of documents.

- Can be extended as required
- Available with a filling depth of 6 or 18 mm
- Compatible with all system boxes

System box DIN A4, deep,
Filling depth: **18 mm**

System box DIN A4, flat,
Filling depth: **6 mm**

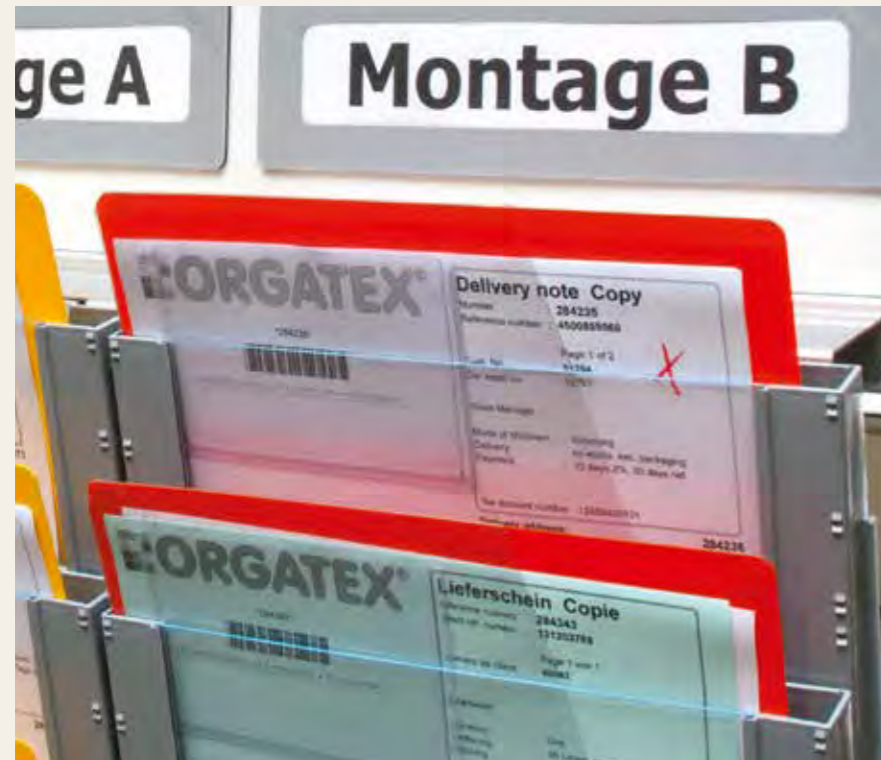

System box DIN A4

Format (WxHxD) (mm)	Filling depth (mm)	Order no.	+ Colour code	Pack
242 x 262 x 6	6	SYSB-A4S-	07 -	10 Pieces
242 x 262 x 6	6	SYSB-A4S-	- 20	10 Pieces
242 x 262 x 18	18	SYSB-A4B-	07 -	10 Pieces
242 x 262 x 18	18	SYSB-A4B-	- 20	10 Pieces

SYSTEM BOX DIN A4: ACCESSORIES



Adjustable base for system box

Order no.	Format (WxH) (mm)
SYSB-A4-WH-1	230 x 175

- Equipped with holes for wall mounting or attachment to our greyboards
- The system boxes are stacked in columns of 1 on the wall bracket
- Incl. mounting material



Additional bracket for system boxes, flat (stainless steel)

Order no.
SYSB-A4S-WH-U

- The penultimate system box of a column can be fixed in place using the additional bracket



Additional bracket for system boxes, deep (stainless steel)

Order no.
SYSB-A4B-WH-U

- The penultimate system box of a column can be fixed in place using the additional bracket

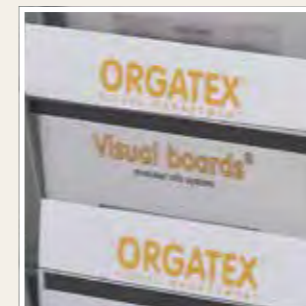

Clip-in label DIN A4, transparent, small

Order no.	Format (WxH) (mm)	Pack
SYSB-A4-HE-90	200 x 90	10 Pieces

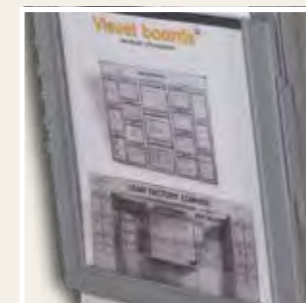

Clip-in label DIN A4, transparent, large

Order no.	Format (WxH) (mm)	Pack
SYSB-A4-HE-242	200 x 242	10 Pieces

KANBAN-SYSTEM BOX



Visible compartment systems for the secure storage of KANBAN cards, label pockets and other documents. Due to the patented connection system, the system boxes can be connected to each other as well as in a block.



KANBAN-System box

Format (WxHxD) (mm)	Order no.	+ Colour code	Pack
118 x 190 x 6	SYSB-	01 02 03 04 05 06 07 -	50 Piece
118 x 190 x 6	SYSB-	- - - - - - - 20	50 Piece

SYSTEM BOX: ACCESSORIES

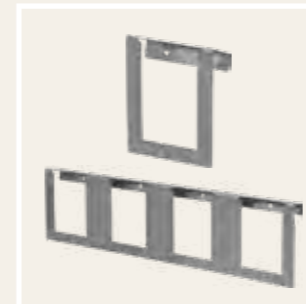

Bracket (Stainless steel)

Order no.	Version	Format (WxH) (mm)
SYSB-WH-1	Bracket, single (Stainless steel)	111 x 166
SYSB-WH-4	Bracket, 4-fold (Stainless steel)	486 x 166

- Equipped with holes for wall mounting or attachment to our greyboards
- The system boxes are stacked in columns of 1 or 4 on the wall bracket
- Incl. mounting material

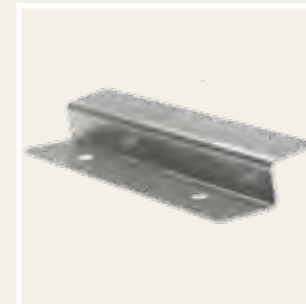

Additional bracket (Stainless steel)

Order no.

SYSB-WH-U

- The penultimate system box of a column can be fixed in place using the additional bracket

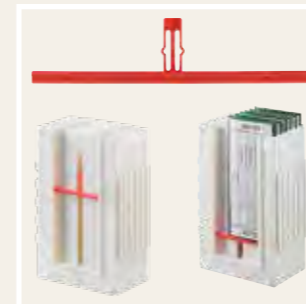

Adjustable base for system box

Order no.	Pack
SYSB-FH	50 Pieces

- Adjustable in 5 mm increments
- System box can be adjusted to individual card size



Insert label, transparent, small

Order no.	Matching cardboard insert	Pack
SYSB-HE-35	ET33-75K	50 Pieces

SYSTEM BOX: ACCESSORIES



Label holder for back edge

Order no.	Pack
SYSB-RS-120	50 Pieces



Block Label

Order no.	Pack
SYSB-HE-35-SPERR	50 Pieces



Insert label, transparent, large

Order no.	Matching Cardboard insert	Pack
SYSB-HE-169	ET75-168K	50 Pieces



Cardboard inserts

Order no.	+ Colour code	Suitable for	Cardboard inserts per Pack	Sheet DIN A4
ET33-75K-	01 02 04 05	SYSB-HE-35	160	10
ET33-168K-	01 02 04 05	SYSB-HE-169	30	10

CARDPLAN® BOARDS



The base of the Cardplan® Boards is made of sturdy, torsion-free metal. Insertion slots made of light grey, hard-wearing plastic are attached one below the other. The insertion slots are designed so that both individual documents and small stacks of documents (up to a maximum thickness of 2 mm) are securely fixed and can be inserted or removed with a single movement. The frameless panels (except A4 horizontal and A4 vertical) can be combined to any width or extended later. The boards are compatible with our greyboards.

The visible edge is the part of the inserted document that protrudes from the insertion flap. The part of the document covered by the insertion flap (inserted) is referred to as the insertion depth.

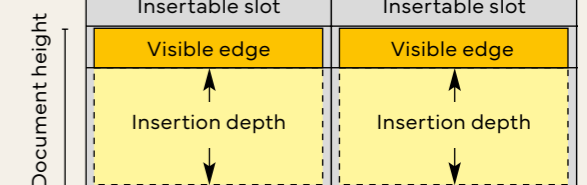
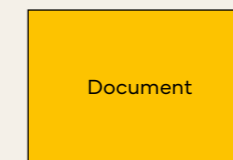

CARDPLAN® BOARDS

Cardplan® Boards						
	Visible edge	Panel height	Insertable scale	Width 250 mm/ Order no.	Width 500 mm/ Order no.	
Document height 74 mm	20 mm	440 mm	17	K217-20-G	K517-20-G	
	20 mm	795 mm	34	K227-20-G	K527-20-G	
DIN A7 landsc. or DIN A8 portr.	20 mm	1085 mm	51	K237-20-G	K537-20-G	
	20 mm	1244 mm	59	K247-20-G	K547-20-G	
	30 mm	440 mm	11	K217-30-G	K517-30-G	
	30 mm	795 mm	23	K227-30-G	K527-30-G	
	30 mm	1085 mm	33	K237-30-G	K537-30-G	
	30 mm	1244 mm	39	K247-30-G	K547-30-G	
Document height 100 mm	30 mm	440 mm	11	K212-30-G	K512-30-G	
	30 mm	795 mm	23	K222-30-G	K522-30-G	
	30 mm	1085 mm	33	K232-30-G	K532-30-G	
	30 mm	1244 mm	38	K242-30-G	K542-30-G	
Document height 105 mm	20 mm	440 mm	16	K216-20-G	K516-20-G	
	20 mm	795 mm	34	K226-20-G	K526-20-G	
DIN A6 landsc. or DIN A7 portr.	20 mm	1085 mm	50	K236-20-G	K536-20-G	
	20 mm	1244 mm	56	K246-20-G	K546-20-G	
Document height 148 mm	20 mm	440 mm	14	K215-20-G	K515-20-G	
	20 mm	795 mm	32	K225-20-G	K525-20-G	
DIN A5 landsc. or DIN A6 portr.	20 mm	1085 mm	46	K235-20-G	K535-20-G	
	20 mm	1244 mm	53	K245-20-G	K545-20-G	
	30 mm	440 mm	10	K215-30-G	K515-30-G	
	30 mm	795 mm	21	K225-30-G	K525-30-G	
	30 mm	1085 mm	31	K235-30-G	K535-30-G	
	30 mm	1244 mm	36	K245-30-G	K545-30-G	
	40 mm	440 mm	7	K216-40-G	K516-40-G	
	40 mm	795 mm	16	K226-40-G	K526-40-G	
	40 mm	1085 mm	23	K236-40-G	K536-40-G	
	40 mm	1244 mm	28	K246-40-G	K546-40-G	
	60 mm	440 mm	5	K216-60-G	K516-60-G	
	60 mm	795 mm	11	K226-60-G	K526-60-G	
	60 mm	1085 mm	16	K236-60-G	K536-60-G	
	60 mm	1244 mm	19	K246-60-G	K546-60-G	

Cardplan® Boards						
	Visible edge	Panel height	Insertable scale	Width 250 mm/ Order no.	Width 500 mm/ Order no.	
Document height 210 mm	15 mm	795 mm	36	K224-15-G*	K524-15-G	
	15 mm	1085 mm	56	K234-15-G*	K534-15-G	
DIN A4 landsc. or DIN A5 portr.	20 mm	440 mm	11	K214-20-G*	K514-20-G*	
	20 mm	795 mm	29	K224-20-G*	K524-20-G*	
With lateral aluminium end frame.	20 mm	1085 mm	43	K234-20-G	K534-20-G*	
	20 mm	1244 mm	49	K244-20-G*	K544-20-G*	
	30 mm	440 mm	8	K214-30-G*	K514-30-G*	
	30 mm	795 mm	19	K224-30-G*	K524-30-G*	
	30 mm	1085 mm	29	K234-30-G*	K534-30-G*	
	30 mm	1244 mm	35	K244-30-G*	K544-30-G*	
	90 mm	440 mm	3	K215-90-G*	K515-90-G	
	90 mm	795 mm	7	K225-90-G*	K525-90-G	
	90 mm	1085 mm	10	K235-90-G*	K535-90-G	
	90 mm	1244 mm	12	K245-90-G*	K545-90-G*	
Document height 297 mm	30 mm	440 mm	5	K213-30-G*	K513-30-G*	
	30 mm	795 mm	17	K223-30-G*	K523-30-G*	
DIN A3 landsc. or DIN A4 portr.	30 mm	1085 mm	26	K233-30-G*	K533-30-G*	
	30 mm	1244 mm	31	K243-30-G*	K543-30-G	
With lateral aluminium end frame.	60 mm	440 mm	3	K213-60-G	K513-60-G*	
	60 mm	795 mm	9	K223-60-G*	K523-60-G*	
	60 mm	1085 mm	13	K233-60-G*	K533-60-G*	
	60 mm	1244 mm	16	K243-60-G*	K543-60-G*	
	90 mm	440 mm	2	K213-90-G*	K513-90-G*	
	90 mm	795 mm	6	K223-90-G*	K523-90-G*	
	90 mm	1085 mm	9	K233-90-G*	K533-90-G*	
	90 mm	1244 mm	10	K243-90-G*	K543-90-G*	

CARDPLAN®: ACCESSORIES

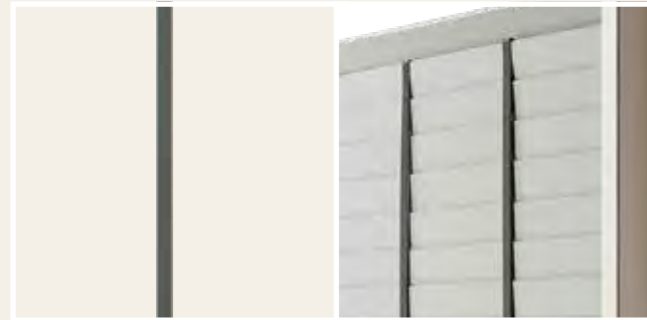

Vertical divider for Cardplan® boards			
Length (mm)	Order no.	Pack	
1020	KST1020	10 Pieces	
1220	KST1220	10 Pieces	

KST1020: can be used for panel heights 440 mm, 795 mm and 1085 mm.
KST1220: can be used for panel heights of 1244 mm.

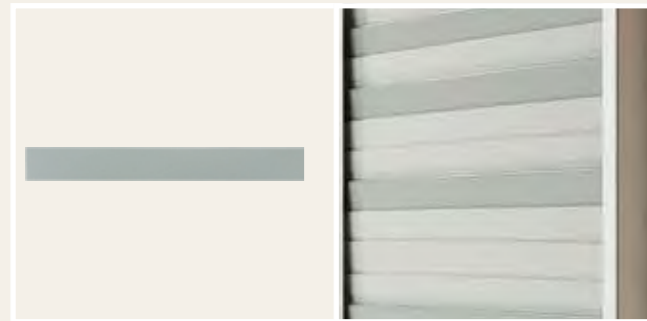

Horizontal divider for Cardplan® boards			
Length (mm)	Order no.	Pack	
250	KAN-AMPEL250/6	10 Pieces	
500	KAN-AMPEL500/6	10 Pieces	

Colour: Grey.
Are simply placed over the insertion scale at the desired position.



Label holder for Cardplan® boards			
Length x Height (mm)	Order no.	Pack	
75 x 15	KE75-15	10 Pieces	
75 x 20	KE75-20	10 Pieces	
210 x 20	KE210-20	10 Pieces	
75 x 30	KE75-30	10 Pieces	
210 x 30	KE210-30	10 Pieces	

Simply insert the labels into the transparent label holders and hang them in the desired position in the insertion flap.



Colour labels for Cardplan® boards				
Length (mm)	Order no.	+ Colour code	Pack	
75	KAN-AMPEL75/	1 4 5 6	10 Pieces	
85	KAN-AMPEL85/	1 4 5 6	10 Pieces	
120	KAN-AMPELA7/	1 4 5 6	10 Pieces	
155	KAN-AMPELA6/	1 4 5 6	10 Pieces	
215	KAN-AMPELA5/	1 4 5 6	10 Pieces	
250	KAN-AMPEL250/	1 4 5 6	10 Pieces	
500	KAN-AMPEL500/	1 4 5 6	10 Pieces	

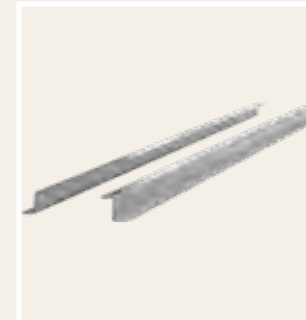

Z-profiles		
Length (mm)	Order no.	
500	Z500	
750	Z750	
1000	Z1000	

Colour: Grey.
Aluminium Z-profiles for wall mounting of the panels.
Set = top and bottom rail.



Rails		
Length (mm)	Order no.	
500	KR2203-50-G	
1290	KR2203-00-G	

Colour: Grey.
Running rails, powder-coated, for wall mounting (not for planning panel stands).
Set = top and bottom rail.



Sheet with magnets		
For Board-Width (mm)	Order no.	
250 ¹	K2-BLM4	
500 ²	K5-BLM6	

Set = 2 pieces incl. screws and Allen key, ready for installation
¹ With 4 neodymium magnets.
² With 6 neodymium magnets.
Can be used up to panel height 1085 mm.
Can be mounted on Cardplan® boards from production date 08/2016.



Greyboard 440 mm/795 mm/1085 mm/1244 mm				
Format (WxH) (mm)	Order no.		Format (WxH) (mm)	Order no.
250 x 440	K210-G		250 x 1244	VB-250-G
500 x 440	K511-G		350 x 1244	VB-350-G
250 x 795	K220-G		500 x 1244	VB-500-G
500 x 795	K521-G		700 x 1244	VB-700-G
250 x 1085	K230-G		1000 x 1244	VB-1000-G
500 x 1085	K531-G			

PLANNING PANEL STAND, HANGING RAILS

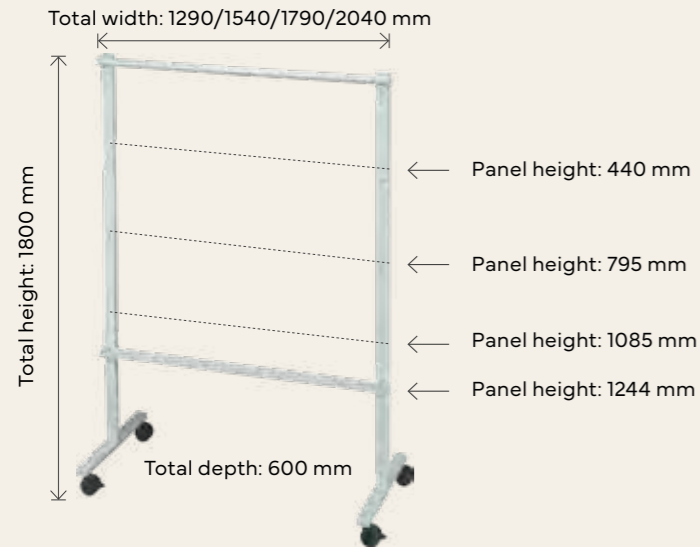

The planning board stand is powder coated and can be used on both sides. The 4 mounted castors, 2 with brakes, enable flexible use. For all available greyboards and Cardplan boards. Delivery includes runners and lockable castors. The height of the shelves can be adjusted in 4 positions.

Planning panel stand, hanging rails

Version	Suitable For/Length (cm)	Colour	Order no.
Metal frame on castors with integrated rails	Panel sizes up to 129 cm overall width	Grey	KS129-G
Metal frame on castors with integrated rails	Panel sizes up to 154 cm overall width	Grey	KS154-G
Metal frame on castors with integrated rails	Panel sizes up to 179 cm overall width	Grey	KS179-G
Metal frame on castors with integrated rails	Panel sizes up to 204 cm overall width	Grey	KS204-G
Additional rails for double occupancy	129	Grey	KRS129-G
Additional rails for double occupancy	154	Grey	KRS154-G
Additional rails for double occupancy	179	Grey	KRS179-G
Additional rails for double occupancy	204	Grey	KRS204-G

1 Set = top and bottom rail insmall fastening material.

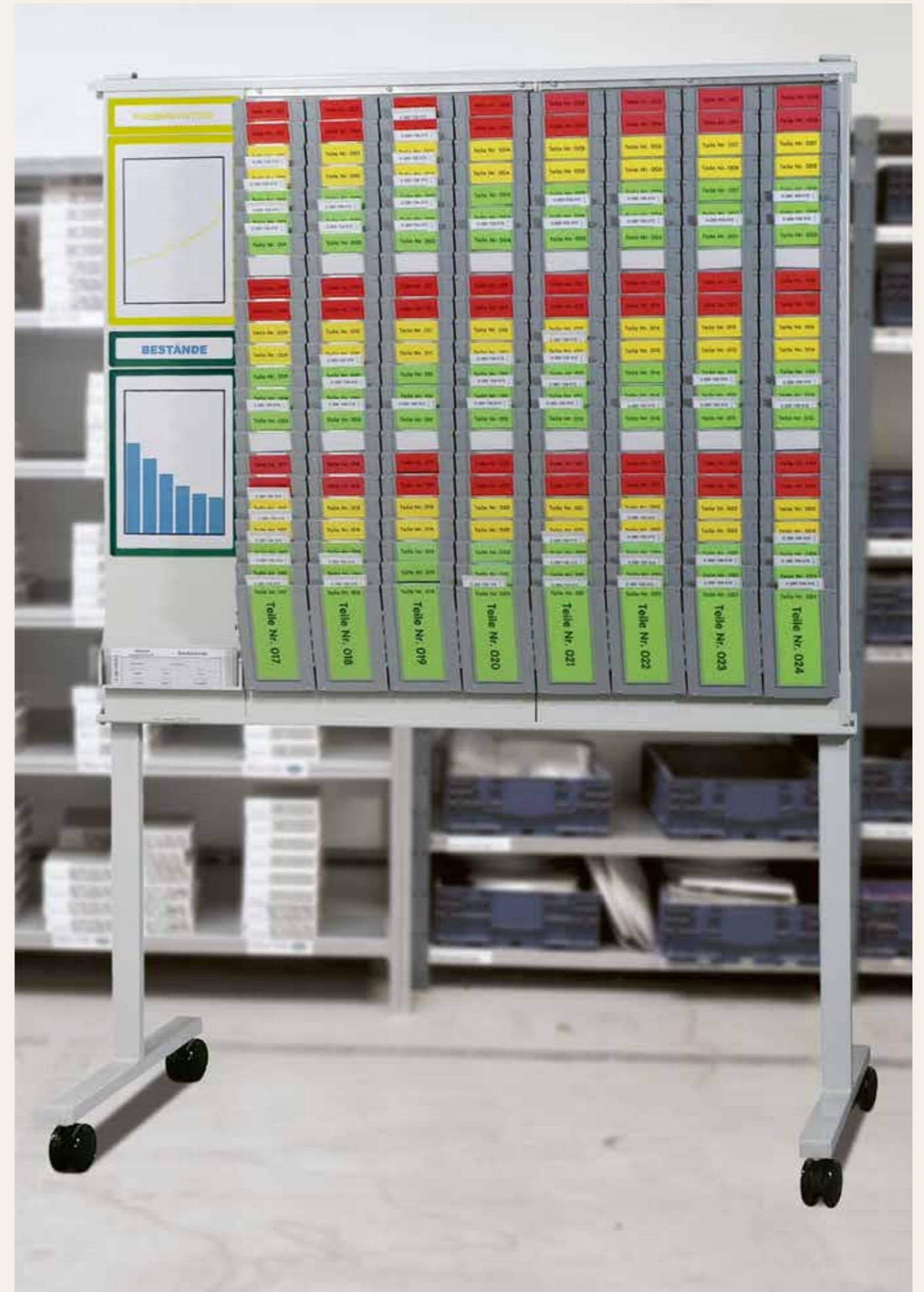

TRANSPARENT PANELS



The transparent panel system is the practical and flexible information carrier for all workstations that require clearly organised information. Price lists, tables, drawings, instructions, illustrations or other information can be inserted into the crystal-clear, transparent display boards in A4 portrait format. Texts can simply be inserted and hung onto the various mounting elements. For example, they can be placed on tables or attached to walls, shelves and tables very simply. The highlight: the elements for wall mounting are now also available in a magnetic version. So information can be quickly and securely attached and removed from all ferrous surfaces without any assembly work.

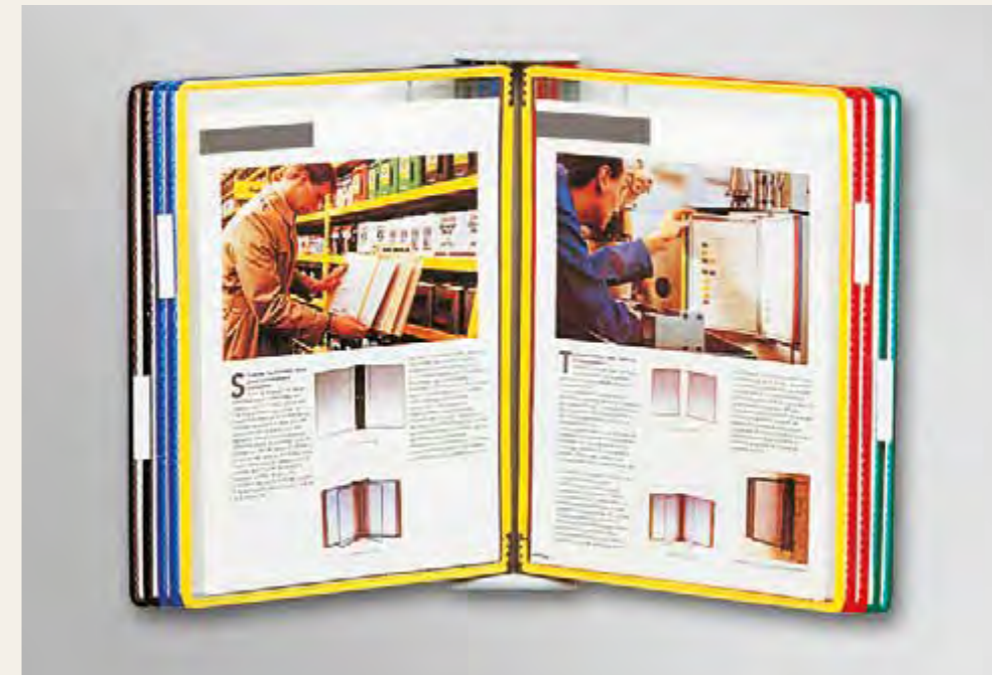

TRANSPARENT PANELS: ACCESSORIES



Desk				
Number transparent panels	Colour	Order no.	Order no. US	
10	Grey	OT410	OT410-US-WS	
20	Grey	OT420	OT420-US-WS	
30	Grey	OT430	OT430-US-WS	

Sturdy, stable metal design for holding 10, 20 or 30 clear view panels in A4 portrait format.

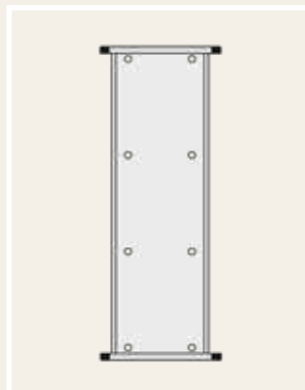

Wall elements for screwing on			
Version	Order no.	Order no. US	
Basic element with stop	OT411	OT411-US-WS	
Extension unit	OT412	-	

For holding 10 transparent panels each.
Can be extended as required by attaching the elements next to each other.
The basic element has removable stop supports as lateral supports.

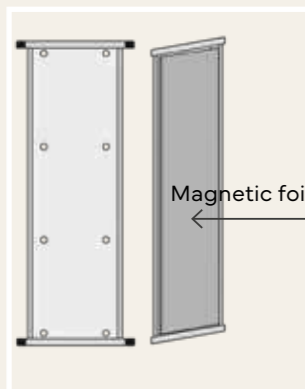

Wall element with magnetic foil on the back			
Version	Order no.	Order no. US	
Basic element with stop	OT415	OT415-US-WS	
Extension unit	OT416	-	

For holding 10 transparent panels each.
Quick, uncomplicated attachment to all ferrous surfaces (e.g. shelf crossbars, steel cabinets) thanks to the highly adhesive magnetic foil on the back.

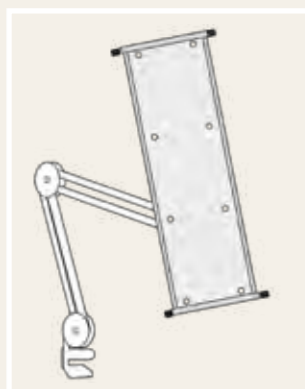

Swivel arm with mounted wall element			
Number transparent panels	Order no.	Order no. US	
10	OT417	OT417-US-WS	

With internal spring, for holding 10 transparent boards.
Easy to mount on a desk with a desk clamp.

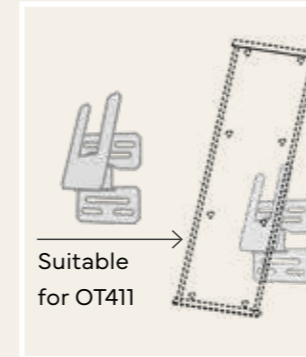

Shelf bracket with swivel support			
Number transparent panels	Order no.	Order no. US	
10	OT418	OT418-US-WS	

The shelf bracket enables wall elements to be attached to any perforated panel or shelf crossbar. Lateral rotation angle 120°, ideal reading angle.

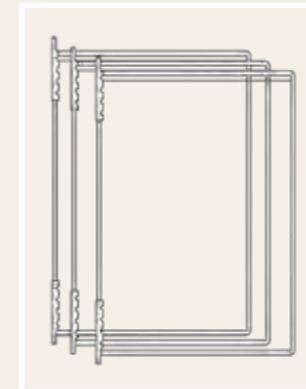

Transparent panels DIN A4 portrait			
Colour	Order no.	Order no. US	Pack
White	OT440	OT440-US-WS	10 Pieces
Red	OT441	OT441-US-WS	10 Pieces
Blue	OT442	OT442-US-WS	10 Pieces
Yellow	OT443	OT443-US-WS	10 Pieces
Green	OT444	OT444-US-WS	10 Pieces

Transparent, made of non-reflective plastic film, framed with plastic-coated steel wire. Easy insertion thanks to pivot pin.

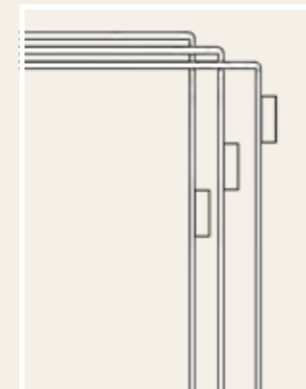

Slip-on tabs for transparent panels			
Order no.	Order no. US	Length (mm)	Pack
OT50	OT50	50	10 Pieces

For clear sheets DIN A4 portrait, 1 cardboard insert (height 12 mm) per tab.

KANBAN-LETTERBOX, TRANSPARENT



The KANBAN letterboxes provide secure storage for your KANBAN cards and have a high filling capacity. Suitable for wall mounting, as a stand-alone solution or magnetic.

- KANBAN letterbox, transparent (KN-BK-35), for KANBAN cards according to VDA standard 4902
- Sufficient for up to 40 KANBAN cards, high filling capacity for all formats

KANBAN Letterbox, transparent

Version	Order no.	Width x Height (mm)	Pack
Transparent, > 35 mm	KN-BK-35	115 x 165	2 Pieces
Transparent, DIN A5 > 35 mm	KN-BK-A5-35	165 x 165	2 Pieces
Transparent, DIN A4 > 35 mm	KN-BK-A4-35	230 x 250	1 Piece
Transparent, DIN A5 square > 40 mm	KN-BK-A5Q-35	217 x 127	2 Pieces
ESD black DIN A6 > 35 mm	KN-BK-35-ESD-06	114 x 153	2 Pieces
Transparent, magnetic, > 35 mm	KN-BKM-35	115 x 165	2 Pieces
Transparent, magnetic, DIN A5 > 35 mm	KN-BKM-A5-35	165 x 165	2 Pieces
Transparent, magnetic, DIN A4 > 35 mm	KN-BKM-A4-35	230 x 250	1 Piece
Transparent, magnetic, DIN A5 square > 40 mm	KN-BKM-A5Q-35	217 x 127	2 Pieces



PRIMUS VISUAL COMPARTMENT SYSTEMS



Whether in the warehouse, workshop, factory or office: Our Primus display compartment systems are suitable for all requirements!

You can create any desired height and width. You can extend or regroup at any time, e.g. form rows of compartments, hang up individual compartments. For extensions, simply pull out the end panel and attach further extension elements or arrange them in any desired position.

All elements can be regrouped, extended or subdivided vertically or horizontally at any time. The individual columns can be stabilised at the bottom edge using the additional bracket.

It's that simple:

Attach wall brackets, hang the required number of shelves one below the other, close the last shelf with a front panel – and the row is complete.

And if you want to expand?

Either pull out the front panel and attach additional viewing compartments or place them anywhere in between.

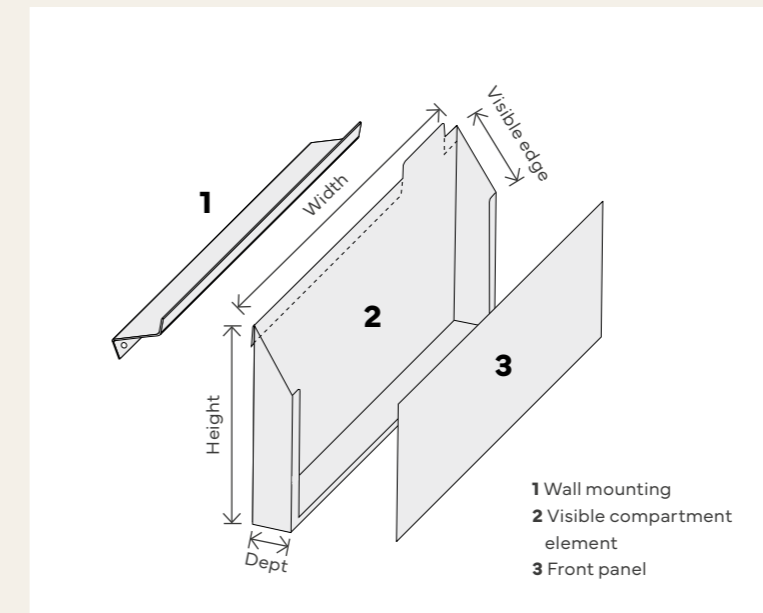

PRIMUS COLUMN OR ROW SYSTEMS/ACCESSORIES



Basic element with grey front panel

For documents in DIN-Format	Format (WxH) (mm)	Order no.	€/Piece	Extension element
DIN A4 landsc./DIN A5 portr.	337 x 210	SBAM103	19,90 €	SER113
DIN A4 portr.	250 x 300	SBAM104	19,65 €	SER114
DIN A5 landsc./DIN A6 portr.	250 x 150	SBAM105	15,15 €	SER115

Basic element, consisting of wall suspension, display compartment element and grey front panel. Extension unit, consisting of display compartment unit.



Basic element with transparent front panel

For documents in DIN-Format	Format (WxH) (mm)	Order no.	€/Piece	Extension element
DIN A4 landsc./DIN A5 portr.	337 x 210	SBAP103	19,90 €	SER113
DIN A4 portr.	250 x 300	SBAP104	19,65 €	SER114
DIN A5 landsc./DIN A6 portr.	250 x 150	SBAP105	15,15 €	SER115

Basic element, consisting of wall suspension, viewing compartment element and **transparent** front panel. Extension unit, consisting of viewing compartment unit.

Wall element with magnetic foil on the back

Designation	Order no.	€/Pack	Order no.
Labelling labels, self-adhesive	SA12 (10 pieces)	4,08 €	SA32 (50 pieces)
Cardboard inserts, white	SA33 (100 pieces)	4,99 €	
Additional bracket for all DIN formats	SZW110 (1 piece)	3,98 €	

PRIMUS SINGLE COMPARTMENTS



Single compartment with grey front panel

For documents in DIN-Format	Format (WxH) (mm)	Order no.
DIN A4 landsc./DIN A5 portr.	337 x 210	SERM103
DIN A4 portr.	250 x 300	SERM104
DIN A5 landsc./DIN A6 portr.	250 x 150	SERM105

Single element to screw on with **grey** front panel. Without wall mounting.



Single compartment with transparent front panel

For documents in DIN-Format	Format (WxH) (mm)	Order no.
DIN A4 landsc./DIN A5 portr.	337 x 210	SERP113
DIN A4 portr.	250 x 300	SERP114
DIN A5 landsc./DIN A6 portr.	250 x 150	SERP115
1/3 DIN	250 x 100	SERP116

Single element to screw on with **transparent** front panel. Without wall mounting.



Single compartment magnetic, with transparent front panel

For documents in DIN-Format	Format (WxH) (mm)	Order no.
DIN A5 landsc.	250 x 150	KNSERM115
1/3 DIN	250 x 100	KNSERM116

- Made of light grey powder-coated sheet steel, particularly robust and durable
- High capacity thanks to compartment depth of 15 mm

WORK DOCUMENT SLEEVE DIN A4



Work document sleeve for documents in A4 format with transparent film sealed on the back. Welded business card pocket at the top left for notes or additional information.

- Documents readable without removal
- High filling capacity
- Scanner-readable QR code/barcode

PRIMUS WORKSHOP SLEEVE



Working papers, drawings etc. can be summarised and protected in Primus workshop sleeves. Primus workshop sleeves can be hung individually from the cords or from the ring-reinforced eyelets and can also be inserted into Primus display compartments.

- 3 ring-reinforced perforations in the head section
- Velcro fastener on the back
- Filling capacity approx. 7 mm



Work document sleeve DIN A4			
Format (WxH) (mm)	Order no.	+ Colour code	Pack
230 x 314	STP420-	01 02 03 04 05 06 08 88	10 Pieces

Primus workshop sleeve DIN A4		
Format (WxH) (mm)	Order no.	Pack
240 x 330	ATP420	10 Pieces



HANGING FRAMES & SIGNS

People are visually orientated and take in 80% of all information with their eyes. This makes visualisation tools at the workplace even more important, for example to mark storage and storage locations or to communicate important information in a clearly visible way.



[katalog.orgatex.com/
poster-frame-schilder](https://katalog.orgatex.com/poster-frame-schilder)

Hanging frame series 100/200

Accessories series 100
Accessories series 100/200
Accessories series 200

From 176

178
182
184

5S suspension

188

Aluminium snap frame

189

ORGATEX® hanging frames are a versatile visualisation tool. They are lighter than conventional frames and are highly resistant thanks to their robust plastic frame. They can therefore also be used in demanding industrial areas. In addition, the non-reflective PVC protective cover can be read by all commercially available scanners. ORGATEX® hanging frames are available in all standard DIN formats and in 8 different colours. They can be used on both sides and in both horizontal and vertical format. With our extensive range of accessories, the frames can be connected or attached, detached and clipped on.

You can attach them in a variety of ways, including to walls and ceilings, containers, crates and/or pallet cages – depending on your individual requirements. This means you are extremely flexible with our hanging frames, as mounting and changing information is quick and easy. Thanks to the patented locking clip, they offer a secure hold.

In addition to the extensive range of hanging frames, ORGATEX® also offers you a complete set for 5S hanging, which facilitates compliance with the 5S method, as well as aluminium snap frames for the secure mounting of signs in DIN format. .



INFOGRAPHIC HANGING SIGN



Extensive range of accessories
We offer various mounting options for the hanging signs. They are specially tailored to your individual needs.

Printing on standard paper (DIN)

Common 5S colours

DIN formats

Anti-reflective protective cover made of PVC
Flexible and fast exchange of information. Scanner readable.

5S suspension
Creates trouble-free processes by adhering to rules. The complete set consists of: Hanging sign, round tube clips, suspension eyelets and round tube.



Quick and easy installation



Low weight



Product only suitable for indoor use!

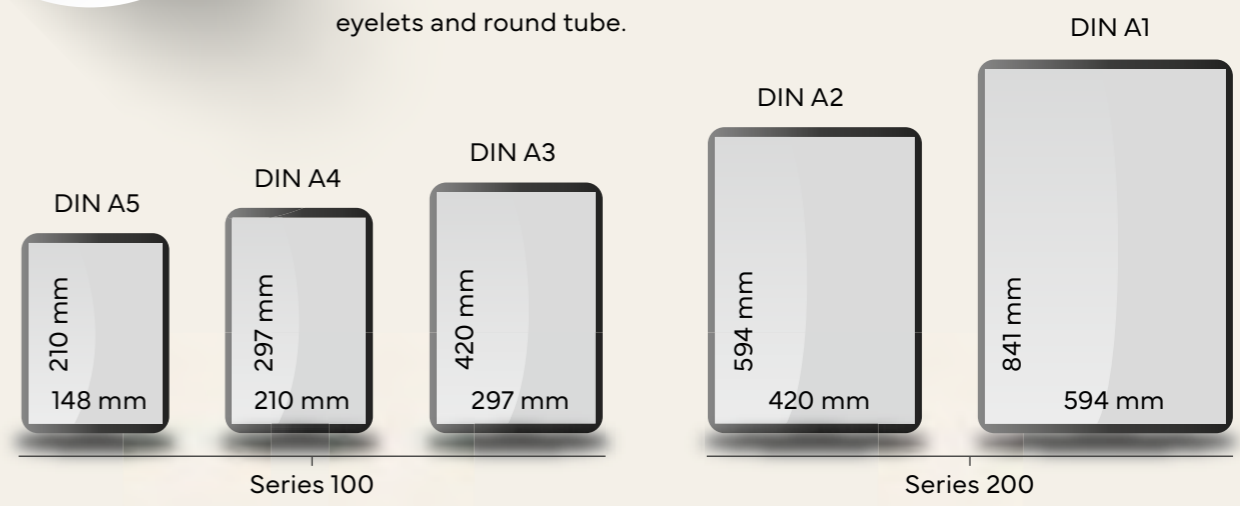
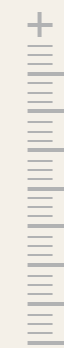



HANGING SIGN SERIES 100/200



- Robust plastic signs (suitable for industrial use)
- Anti-reflective protective covers (scanner-readable)
- All standard DIN formats available
- Can be used in portrait and landscape format

Hanging frame Series 100/200											
Version	Format inside/ outside (W x H) (mm)	Order no.	+ colour code								Pack
			01	02	03	04	05	06	08	88	
DIN A5 (Series 100)	148 x 210 / 153 x 218	PKR-A5-100-	01	02	03	04	05	06	08	88	5 pieces
DIN A4 (Series 100)	210 x 297 / 217 x 305	PKR-A4-100-	01	02	03	04	05	06	08	88	5 pieces
DIN A3 (Series 100)	297 x 420 / 305 x 427	PKR-A3-100-	01	02	03	04	05	06	08	88	5 pieces
DIN A2 (Series 200)	420 x 594 / 430 x 600	PKR-A2-200-	-	-	-	-	-	-	-	88	5 pieces
DIN A1 (Series 200)	594 x 841 / 600 x 846	PKR-A1-200-	-	-	-	-	-	-	-	88	5 pieces





ACCESSORIES SERIES 100



Pipe clamp (counterpart to PKR-CL-AP-100)

Order no.	Series	Pack
PKR-CL-RKW-100	100	10 pieces

- White plastic tube clamp for attaching hanging signs to tubes with a diameter of 23 to 28 mm
- Only in conjunction with adapter PKR-CL-AP-100



Adapter

Order no.	Series	Pack
PKR-CL-AP-100	100	10 pieces

- Parallel for mounting hanging signs of the 100 series in conjunction with tube clamp PKR-CL-RKW-100

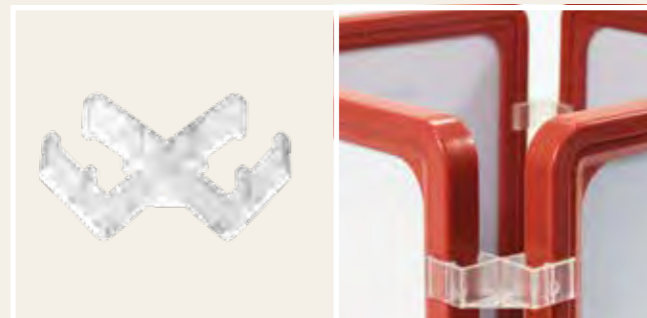

Mounting for hanging frames

Order no.	Series	Pack
PKR-CL-VA-100	100	10 pieces

- Square suspension made of transparent plastic

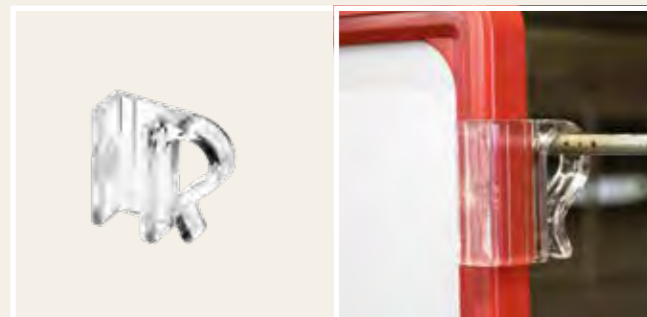

Grid hook

Order no.	Series	Pack
PKR-CL-GH-100	100	10 Paar

- Transparent plastic grid hook for parallel attachment of Series 100 hanging signs to wire grids up to a maximum diameter of 10 mm

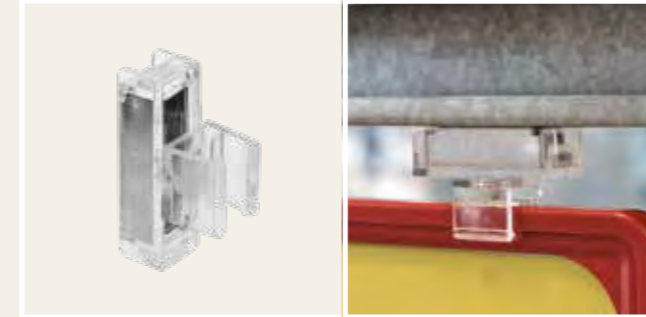

Magnetic holder, rotatable

Order no.	Series	Pack
PKR-CL-MAD-100	100	10 pieces

- Transparent, 360° rotatable plastic magnetic holder with magnetic core
- Holding force up to approx. 2.8 kg



Clamp

Order no.	Series	Pack
PKR-CH-100	100	20 pieces

- For T-piece for clamping to round pipes, mouldings etc.

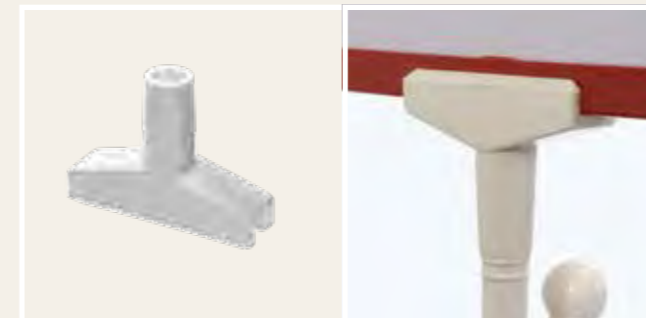

T-piece (counterpart to PKR-CH-100)

Order no.	Series	Pack
PKR-CL-T60-100	100	20 pieces

- White plastic T-piece, 60 mm, only to be used in conjunction with clamp PKR-CH-100



Bracket (for screwing on)

Order no.	Series	Pack
PKR-CL-SHD-100	100	10 pieces

- Transparent, 360° rotatable plastic holder for screwing on

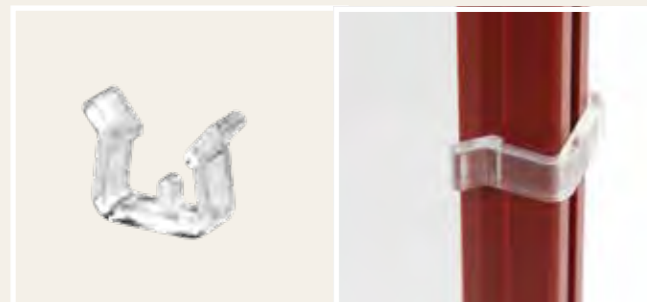

Locking clip

Order no.	Series	Pack
PKR-CL-VS-100	100	10 pieces

- Transparent plastic -Locking clip, prevents the protective cover from falling out of the hanging sign

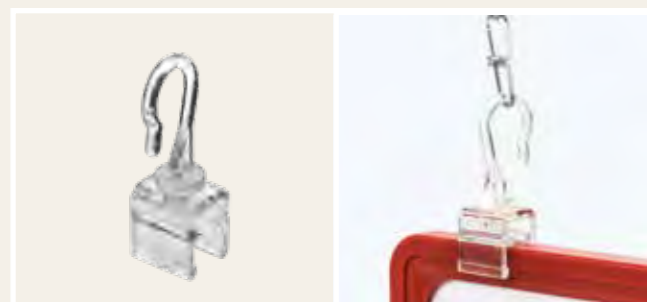

Suspension hook

Order no.	Series	Pack
PKR-CL-HK-100	100	10 pieces

- Transparent plastic suspension hook for hanging sign
- 360° rotatable

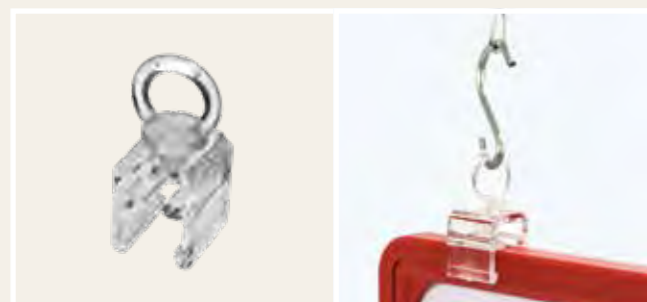

Suspension eye

Order no.	Series	Pack
PKR-CL-OED-100	100	10 pieces

- Transparent plastic hanging loop for hanging the hanging signs
- 360° rotatable



Wall bracket (self-adhesive)

Order no.	Series	Pack
PKR-CL-WH-100	100	10 pieces

- With additional hole for screw fastening
- Transparent plastic wall bracket



Crate clamp (counterpart to PKR-RCL-100)

Order no.	Series	Pack
PKR-CL-KK-100	100	10 pieces

- Transparent plastic crate clamp (rotatable) for attaching hanging signs to crates up to a maximum material thickness of 20 mm

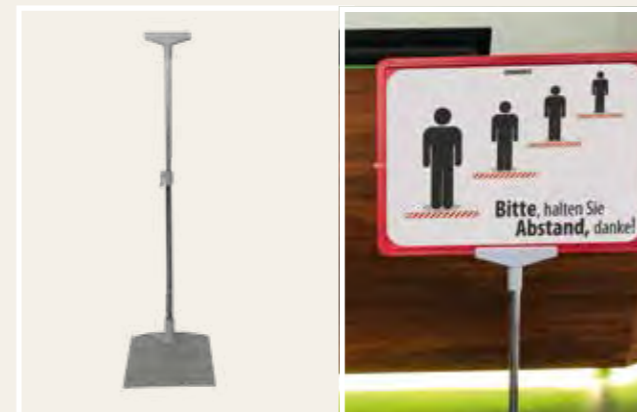

Hanging sign display

Order no.	Series	Colour	Pack
PKR-BST	100	-	5 pieces
PKR-A4-01-SD	100	Red	1 Set

Universal frame stand for holding warning signs in A4 size.
- Rectangular, powder-coated grey metal base plate
- Chrome-plated tubular steel, extendable from 320 to 620 mm, with locking lever and grey tube holder
- DIN A4 hanging frame in ORGATEX® standard colour (only included in the set)

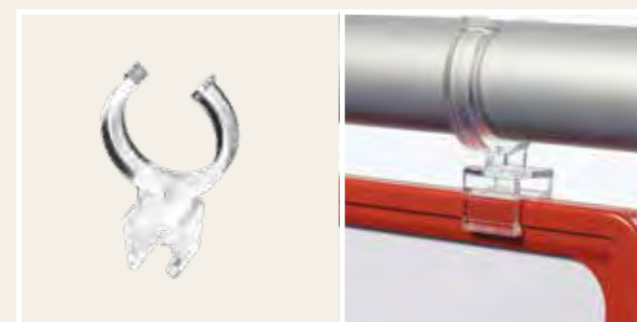

Pipe clamp

Order no.	Series	For pipe-Ø	Pack
PKR-CL-RK-100	100	28 – 30 mm	10 pieces
PKR-CL-RK-35120	100	35 – 38 mm	10 pieces

- Transparent plastic tube clamp for attaching 100 series poster frames to tubes with a diameter of 28 to 38 mm



Frame connector, rotatable

Order no.	Series	Pack
PKR-CL-VB-100	100	10 pieces

- Transparent plastic frame connector for connecting 100 series poster holders



Wall element, rotatable

Order no.	Series
PKR-WHB-100	100

- Can be used in portrait and landscape format
- For sizes in the 100 series
- Holder for scrolling 5 hanging frames



ACCESSORIES SERIES 200



Pipe clamp

Order no.	Series	For pipe-Ø	Pack
PKR-CL-RK-200	200	28 – 33 mm	10 pieces

- Transparent plastic tube clamp for attaching Series 200 hanging frames to tubes with a diameter of 28 to 38 mm



Film hinge

Order no.	Series	Pack
PKR-CL-FS-200	200	10 pieces

- Transparent plastic, for triangular and square connections of Series 200 hanging frames

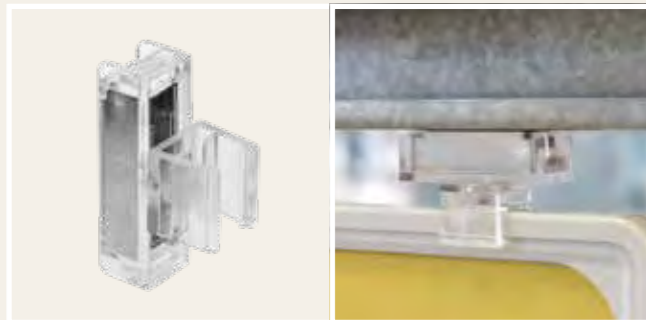

Magnetic holder

Order no.	Series	Pack
PKR-CL-MAD-200	200	10 pieces

- Transparent, 360° rotatable plastic magnetic holder with magnetic core
- Holding force up to approx. 2.8 kg



Wall bracket (self-adhesive)

Order no.	Series	Pack
PKR-CL-WH-200	200	10 pieces

- Transparent plastic wall bracket
- With double-sided adhesive tape



Locking clip

Order no.	Series	Pack
PKR-CL-VS-200	200	10 pieces

- Transparent plastic locking clip, prevents the protective cover from falling out of the poster frame



Suspension eye

Order no.	Series	Pack
PKR-CL-OED-200	200	10 pieces

- Transparent plastic hanging loop for hanging the poster frames
- Infinitely variable rotation for poster insertion at the side



Bracket (for screwing on)

Order no.	Series	Pack
PKR-CL-SHD-200	200	10 pieces

- Transparent, 360° rotatable plastic holder for screwing on



ACCESSORIES SERIES 100/200

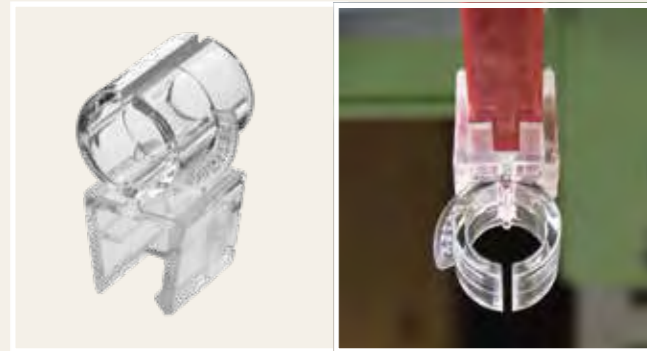

Frame clip (counterpart to PKR-RK-28, PKR-MH, PKR-SKH-30)

Order no.	Series	Pack
PKR-RCL-100	100	10 pieces
PKR-RCL-200	200	10 pieces

- Transparent frame clip with grid for adjusting to the desired angle
- Only in conjunction with PKR-RK-28, PKR-MH or PKR-SKH-30



Frame clip, rotatable by 90° (counterpart to PKR-RK-28, PKR-MH, PKR-SKH-30)

Order no.	Series	Pack
PKR-RCL90-100	100	10 pieces
PKR-RCL90-200	200	10 pieces

- Transparent frame clip with grid for adjusting to the desired angle, rotatable by 90°
- Only in conjunction with PKR-RK-28, PKR-MH or PKR-SKH-30

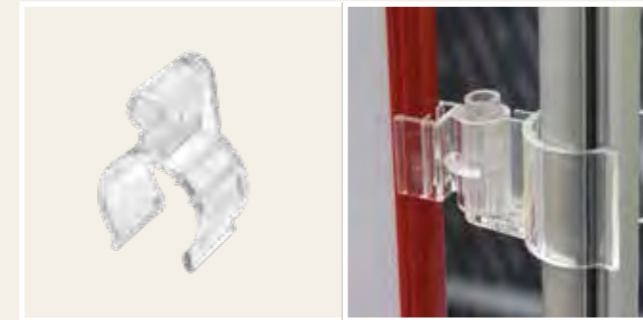

Round tube clip (counterpart to PKR-RCL-100)

Order no.	Series	Pack
PKR-RK-28	100/200	10 pieces

- Transparent round tube clip, can be used in conjunction with frame clip PKR-RCL-100 (rotatable)
- Provides optimum hold on all 28 mm round tubes



Magnetic holder (counterpart to PKR-RCL-100)

Order no.	Series	Pack
PKR-MH	100/200	10 pieces

- Transparent magnetic holder, can be used in conjunction with frame clip PKR-RCL-100 (rotatable)
- Suitable for all magnetic surfaces



Adhesive holder (counterpart to PKR-RCL-100)

Order no.	Series	Pack
PKR-SKH-30	100/200	10 pieces

- Transparent adhesive holder, can be used in conjunction with frame clip PKR-RCL-100 (rotatable)
- Self-adhesive, with excellent adhesive strength on almost all surfaces

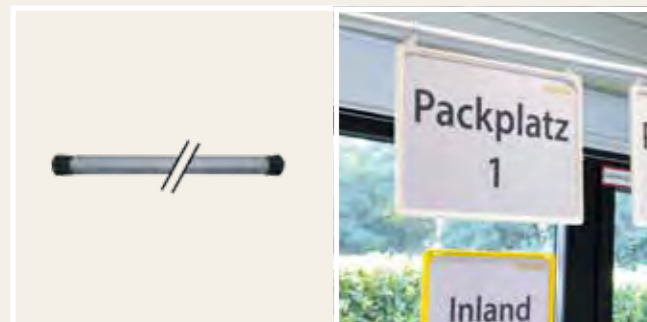

Tubular steel, 2420 mm

Order no.	Series	Format (length)
PKR-R28	100/200	2420 mm

- Tubular steel, silver-grey incl. black PVC end plugs, length 2420 mm, Ø 28 mm

⚠ Recommendation: Ceiling suspension with steel tube should be firmly mounted in the ceiling.



End plug for steel pipe

Order no.	Series	Pack
PKR-RES-28	100/200	10 pieces

- Black PVC end plug for pipe suspension



Tube connector, 100 mm

Order no.	Series
PKR-RV28	100/200

- Tube connector (100 mm) with metal core

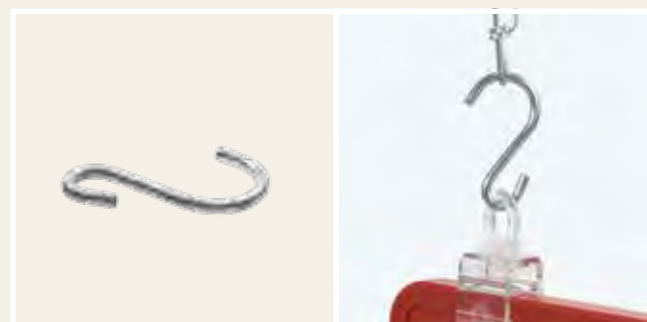

S-Hook, 32 mm

Order no.	Series	Pack
PKR-SHK	100/200	10 pieces

- Made of metal
- For suspending hanging signs using a knotted chain

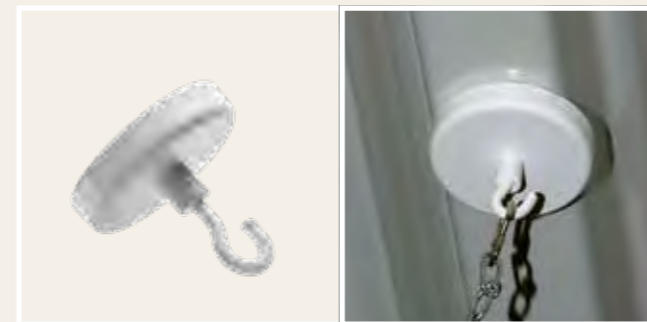

Ceiling magnet with hook

Order no.	Series
PKR-DM50-02	100/200

- White ceiling magnet for attaching hanging signs

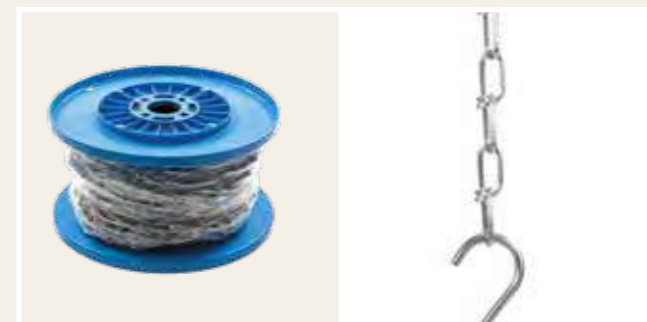

Knotted chain

Order no.	Series	Rolle
PKR-KK	100/200	30 Meter

- Metal knotted chain for attaching hanging signs



Ceiling Clip

Order no.	Series	Pack
PKR-DK	100/200	10 pieces

- White plastic ceiling clip with eyelet, Ø 4 mm



5S-SUSPENSION



The 5S method is used to organise disruption free work processes by observing rules. The 5S suspension system, consisting of a steel tube, hanging signs, and connecting clips, enables compliance with the 5S method and creates a clean and tidy working environment. Consisting of:

- 1 x PKR-R28 (tubular steel, 2420 mm, silver-grey)
- 3 x PKR-A3-100 (white) incl. inlay and clip
- 3 x PKR-A4-100 (yellow, green, red) incl. inlay and clip
- 6 x PKR-CL-RK-100
- 6 x PKR-CL-OED-100
- 6 x PKR-CL-HK-100
- 2 end plugs (black)

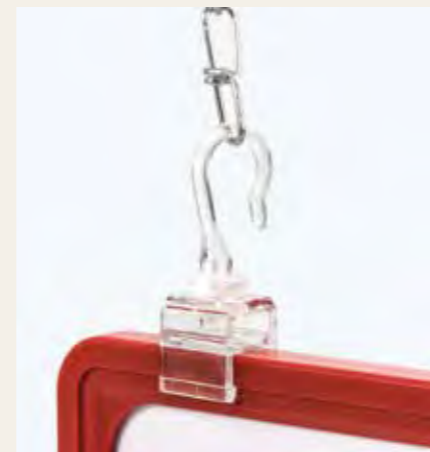

5S Suspension

Order no.

PKR-5S



ALUMINIUM SNAP FRAME



Quick and easy changing of posters in DIN format.

- Available in 5 DIN formats
- Concealed wall mounting holes
- Long-lasting clamping effect thanks to fatigue-free spring steel
- UV-stabilised and anti-reflective cover film



Aluminium snap frame

DIN-Formats	Format (HxB) (mm)	Order no.
DIN A4	343 x 255	KN-ALU-A4
DIN A3	463 x 340	KN-ALU-A3
DIN A2	637 x 463	KN-ALU-A2
DIN A1	884 x 637	KN-ALU-A1
DIN A0	1234 x 882	KN-ALU-A0

VISUAL BOARDS

The quick and uncomplicated provision of information and key figures at central points in the company is an important part of a smooth operating process. Visual boards are the ideal tool for this, as they provide a clear overview of important information at all times. Whether for displaying target and actual statuses, quality indicators or machine running times – visual boards can fulfil a wide variety of functions.



Individual	From 194
Printed Boards	From 196
Info board	198
Theme memory	199
Production meeting	200
SCRUM Board	201
Improvement circle	202
Machine board	203
Wall board	204
Stand-alone board	206
Cube, rotatable	208
Cube	210
Stop	212
Accessories	214



[katalog.orgatex.com/
visual-boards](https://katalog.orgatex.com/visual-boards)

Different board versions are available depending on the area of application: Our wall boards are suitable for permanent use and can be easily attached near machines, for example. Our mobile stand-alone boards, which can also be fitted with shelves or file holders, offer maximum flexibility. Rotatable cubes in central locations allow meetings and team discussions to run more smoothly. Due to their shape, they are also easy to use in places where space is limited. Stops are a clear signpost and stopping point for your milk run. Our entire

visual board portfolio is also available as a whiteboard version for labelling with board markers. A visual board is as individual as the company in which it is used. We design the boards with your company logo and customise them with lettering according to your specifications. We also print customised whiteboards with matrices or tables for you. And if you are looking for a completely customised solution: Our specialist department will design and produce your customised board for you.

INFOGRAPHIC VISUAL BOARDS

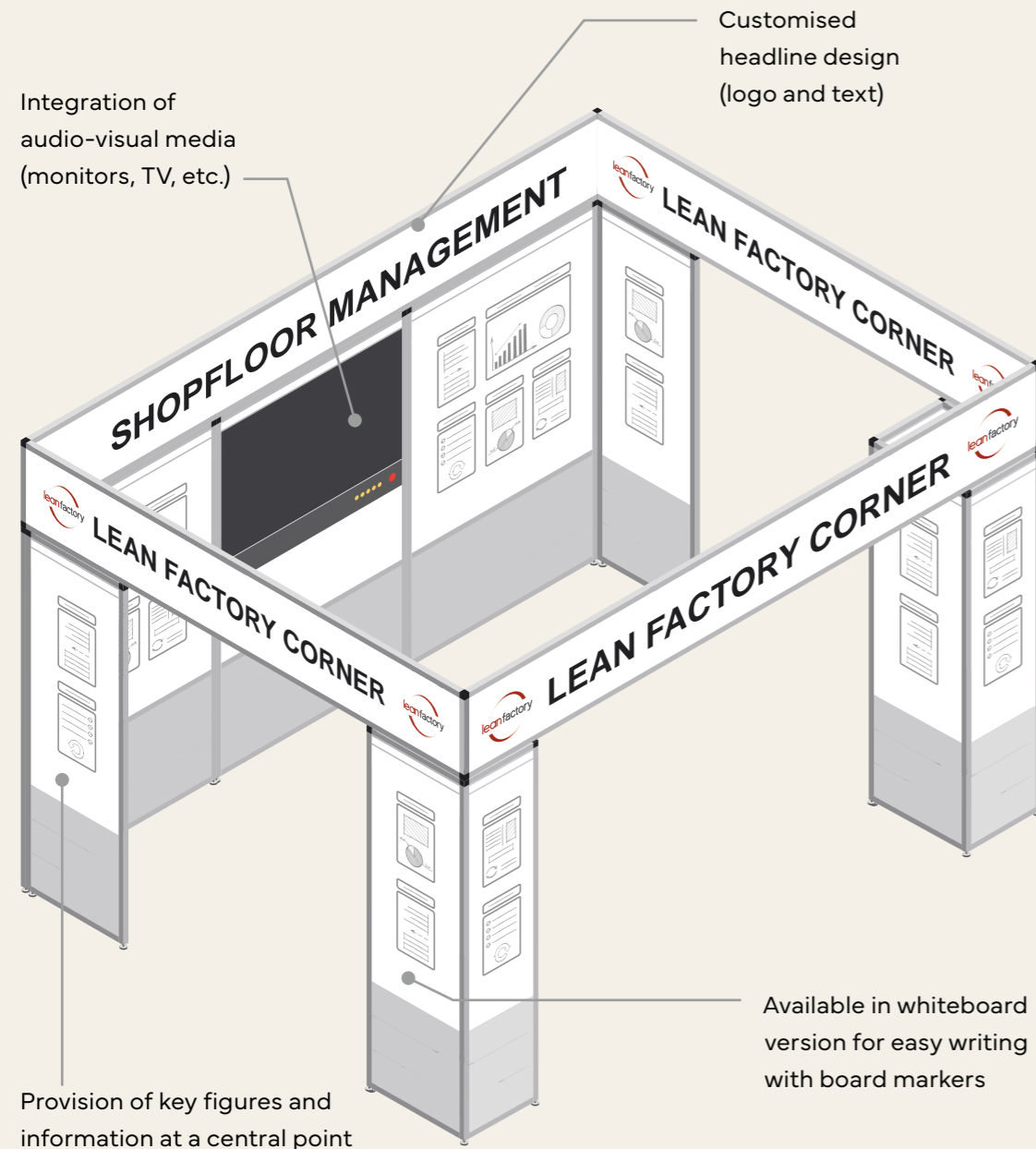

 Production with in-house solutions according to your specifications

 Provision of key figures and information

 Tailored to the needs of your production

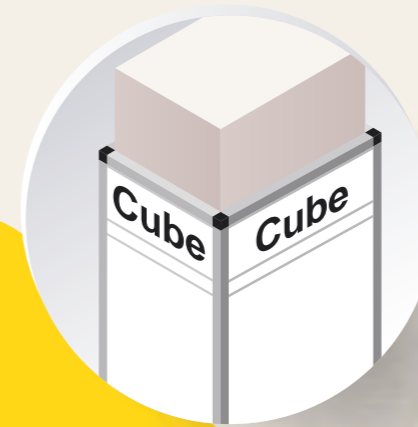

Cube
Our cubes are manufactured from folded sheet metal. The height is set at 2204 mm, the width varies up to 1050 mm as required. Almost limitless combinations are possible. The upper section can also be ordered as a rotatable version.

Inscribable
In whiteboard quality available and can be labelled with a board marker



Media integration
You can integrate all media into our system (aluminium profiles).

Customised specific solutions



Extensive range of accessories



Wall board
The panel widths allow the wall board to be customised in width, only the height is fixed (1444 mm). Wall boards are used wherever mounting options are possible on site, e.g. on walls, machine housings and other permanently installed surfaces.

Stand-alone board
Our stand-alone boards have a standard height of 2170 mm. The board widths allow for customised assembly of the stand-alone board in width. Stand-alone boards can be used flexibly in various locations thanks to a roller stand.

INDIVIDUAL

Design, customised sizes and printing: we design visual boards with in-house solutions entirely according to your specifications. In terms of design, you have the option of adapting the design and size of standard products to your requirements or designing a customised board with our specialist department.



PRINTED BOARDS

Structured whiteboards are the basis of every successful shop floor meeting. We offer a diverse selection of whiteboards with different layouts that have been specially developed by experts for your lean management needs. You can either use proven templates or choose customised layouts according to your preferences. Discover the ideal solution for efficiently organising and visualising your shop floor processes. You will also find useful accessories for structuring the boards in the „document holders“ and „insertion systems“ sections. We use the UV printing process to print on a 0.9 mm thick magnetic sheet, which is characterised by its high quality and scratch resistance. The film can also be used to upgrade existing boards.

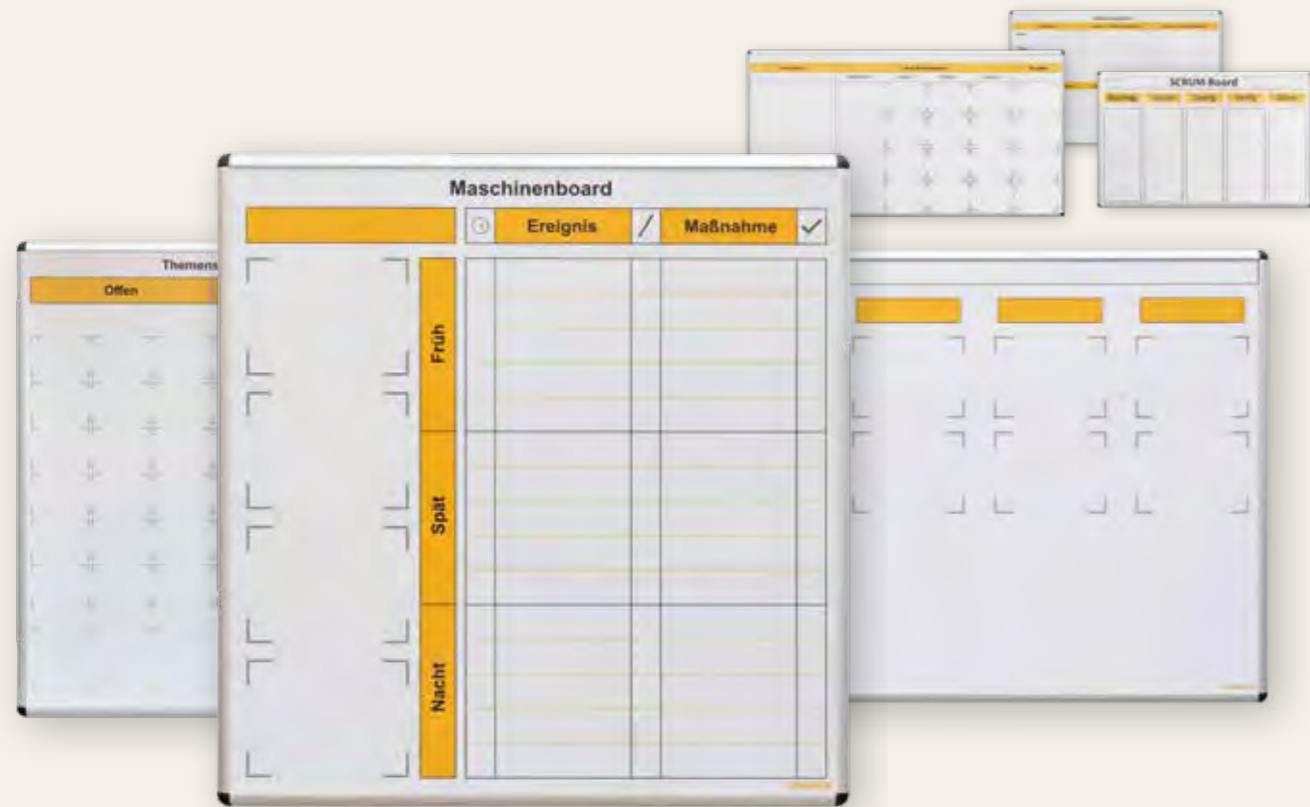

For individual requests

please contact our service team.

Phone: **+49 2173 1064-0**

E-Mail: **sales@orgatex.de**

INFO BOARD



The info board is the central point for regular communication with shop floor employees. Important general information and ongoing projects can be visualised here in a structured manner. However, the overarching and specific key figures that are used to control your operation are of central importance for shop floor management. All employees can thus be actively integrated into your improvement process.

- With magnetic foil, info board layout, scratch resistant and dry-wipeable
- Dimensions (approx.): 1444 mm x 2460 mm x 30 mm (H x W x D)
- Design: Frame made of R-aluminium profiles (30 x 30 mm); 1244 mm x 2400 mm usable area (white edged sheet)



Accessories not included. Please contact our service team.

Info board	
Dimensions (H x W x D)	Order no.
1444 mm x 2460 mm x 30 mm	VB-WA-2400-INFO

TOPIC MEMORY



The topic memory makes the change process palpable and tangible for employees. Problems, challenges and other ideas that are relevant to the working environment can be recorded by employees on topic cards and, with the support of managers, can be recognisably implemented. By categorising the topic cards from „Open“ to „In progress“ to „Completed“, employees can see that concerns are being taken seriously and implemented.

- Visual board with magnetic foil, themed memory layout, scratch resistant and dry-wipeable
- Dimensions (approx.): 1444 mm x 1060 mm x 30 mm (H x W x D)
- Design: Frame made of R-aluminium profiles (30 x 30 mm); 1244 mm x 1000 mm usable area (white edged sheet)

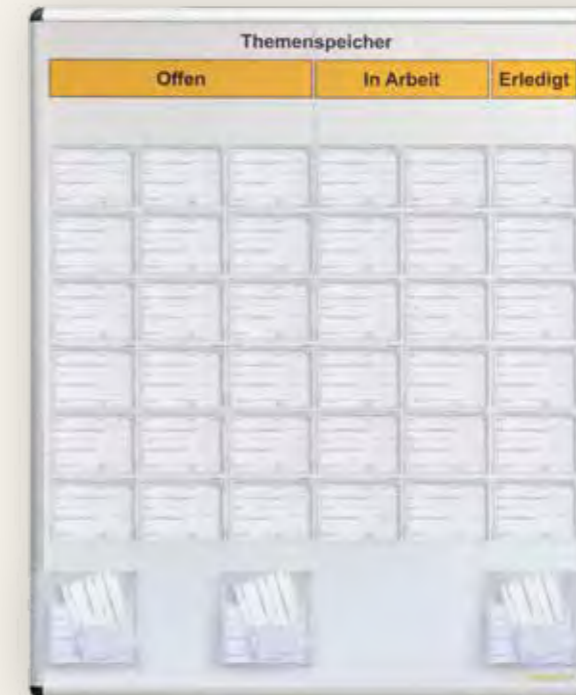

Accessories not included. Please contact our service team.

Info board Topic memory	
Dimensions (H x W x D)	Order no.
1444 mm x 1060 mm x 30 mm	VB-WA-1000-THEM

PRODUCTION MEETING



The aim of an agile production team is to have an early morning/ production phase meeting to make decisions. The events of the last 24 hours and the preview for the next 24 hours are discussed. Key figures over the course of the month as well as daily key figures for the current and previous week provide support. We also recommend the direct allocation and documentation of necessary measures for each system on magnetic strips.

- With magnetic foil, production meeting board layout, scratch-resistant and dry-wipeable
- Dimensions (approx.): 1444 mm x 2060 mm x 30 mm (H x W x D)
- Design: Frame made of R-aluminium profiles (30 x 30 mm); 1244 mm x 2000 mm usable area (white edged sheet)



Accessories not included. Please contact our service team.

Info board Production meeting

Dimensions (H x W x D)	Order no.
1444 mm x 2060 mm x 30 mm	VB-WA-2000-PROD

SCRUM-BOARD



Discover the advantages of the agile project management method SCRUM. Organise your work efficiently, improve team collaboration and increase productivity. With our wall board, you always have an overview of your projects and can lead them to success step by step. Experience a new way of working and be inspired by the flexibility and effectiveness that SCRUM offers you.

- With magnetic foil, SCRUM board layout, scratch-resistant and dry-wipeable
- Dimensions (approx.): 1444 mm x 2060 mm x 30 mm (H x W x D)
- Design: Frame made of R-aluminium profiles (30 x 30 mm); 1244 mm x 2000 mm usable area (white edged sheet)

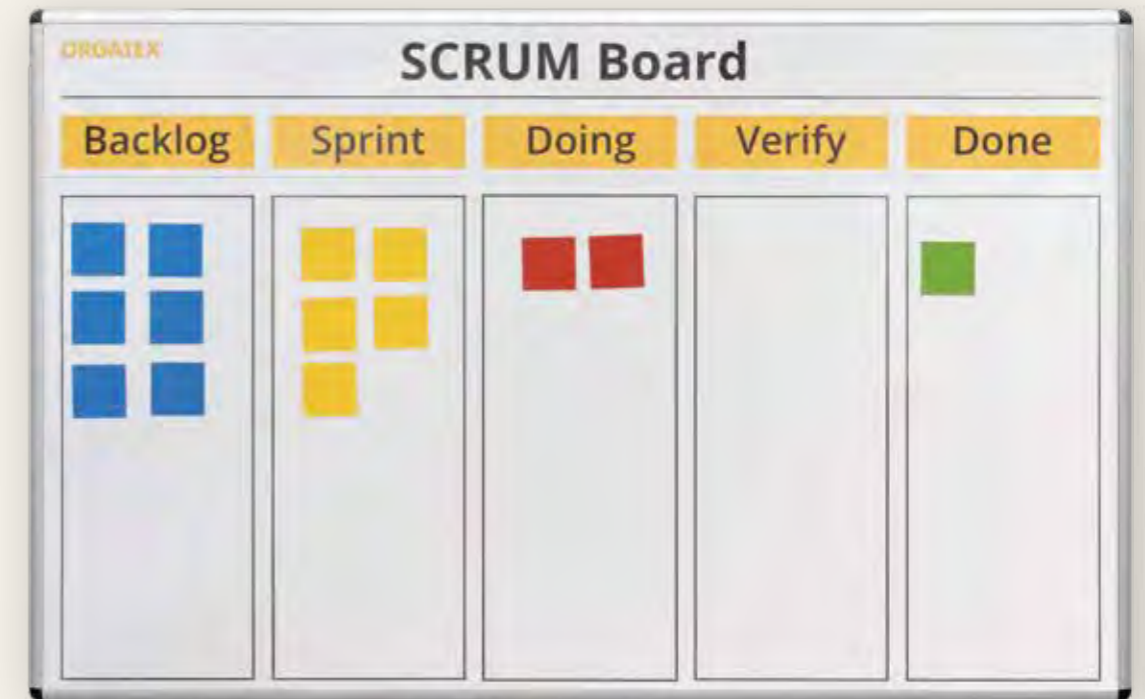

Accessories not included. Please contact our service team.

Info board SCRUM

Dimensions (H x W x D)	Order no.
1444 mm x 2060 mm x 30 mm	VB-WA-2000-SCRUM

IMPROVEMENT CIRCLE



Problems should not be solved at the symptom level, but at the root – the core reason. Our improvement circle board is ideal for efficient and structured problem solving. The procedure is based on the familiar and established DMAIC structure and helps employees to develop sustainable solutions.

- With magnetic foil, improvement circle layout, scratch resistant and dry-wipeable
- Dimensions (approx.): 1444 mm x 2060 mm x 30 mm (H x W x D)
- Version: Frame made of R-aluminium profiles (30 x 30 mm); 1244 mm x 2000 mm usable area (white edged sheet)



Accessories not included. Please contact our service team.

Info board Improvement Circle

Dimensions (H x W x D)	Order no.
1444 mm x 2060 mm x 30 mm	VB-WA-2000-VERB

MACHINE BOARD



What is the current machine performance? What is preventing us from increasing performance or reducing downtimes? Using the machine board, an instrument is provided on the shop floor for each system that makes system-related key figures transparent and is also a medium for cross-shift communication. What has happened in the current shift? What measures have been introduced or still need to be introduced?

- With magnetic foil, machine board layout, scratch resistant and dry-wipeable
- Dimensions (approx.): 1244 mm x 1260 mm x 30 mm (H x W x D)
- Version: Frame made of R-aluminium profiles (30 x 30 mm); 1244 mm x 1260 mm usable area (white edged sheet)



Accessories not included. Please contact our service team.

Info board Machine

Dimensions (H x W x D)	Order no.
1244 mm x 1260 mm x 30 mm	VB-WA-1200-MASCH

WALL BOARD



The wall boards have a standard height of 1444 mm. This height contains:

- Heading 100 mm
- Heading 40 mm
- Whiteboard 1244 mm

- Incl. customised headline
- Whiteboard quality
- Inscrutable with a board marker

Customise the width and headings of your wall board according to your individual requirements.

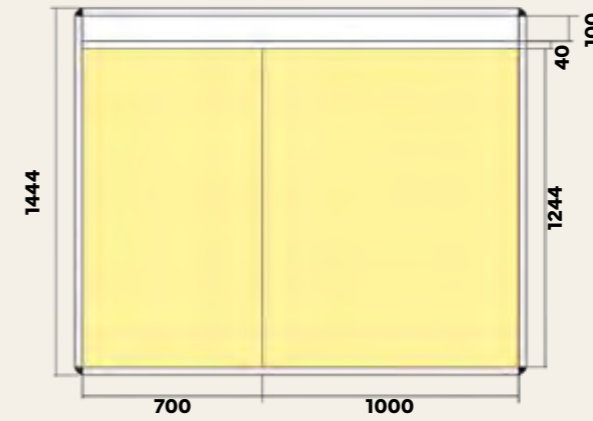

Wall board	
Dimensions (WxH)	Order no.
1060 x 1444 mm	VB-WA-1000-W
1560 x 1444 mm	VB-WA-1500-W
1760 x 1444 mm	VB-WA-1700-W
2060 x 1444 mm	VB-WA-2000-W



STAND-ALONE BOARD



The stand-alone boards have a standard height of 2140 mm.
This height contains:

- Heading 100 mm
- Heading 40 mm
- Whiteboard 1244 mm

- Incl. customised headline
- Whiteboard quality (double-sided)
- Inscrutable with a board marker
- With single-sided shelf (double-sided on request)

Customise the width and headings of your stand-alone board according to your individual requirements.

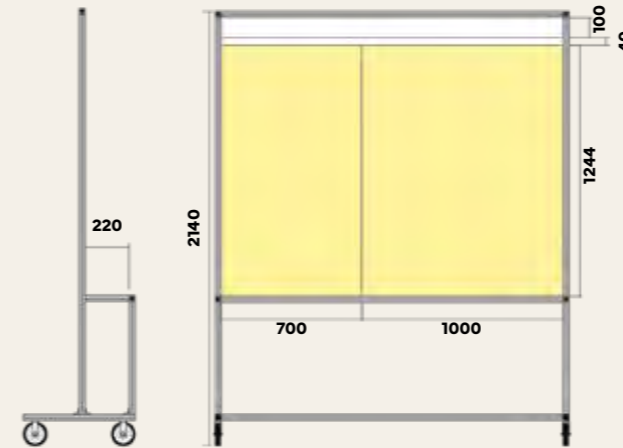

Stand-Alone Board

Dimensions (WxH)	Order no.	Version
1060 x 2140 mm	VB-ST-1000-A	With one-sided shelf
1560 x 2140 mm	VB-ST-1500-A	With one-sided shelf
1760 x 2140 mm	VB-ST-1700-A	With one-sided shelf
2060 x 2140 mm	VB-ST-2000-A	With one-sided shelf



CUBE ROTATABLE



The combination of a fixed lower section and an upper section that can be rotated to 360° gives the cube maximum flexibility. The cubes have a standard height of 2180 mm.

- Heading 100 mm
- Whiteboard 1244 mm

- Incl. customised headline
- Whiteboard quality
- Inscrutable with a board marker
- Height-adjustable disc feet

Customise the width and headings of your cube according to your individual requirements.

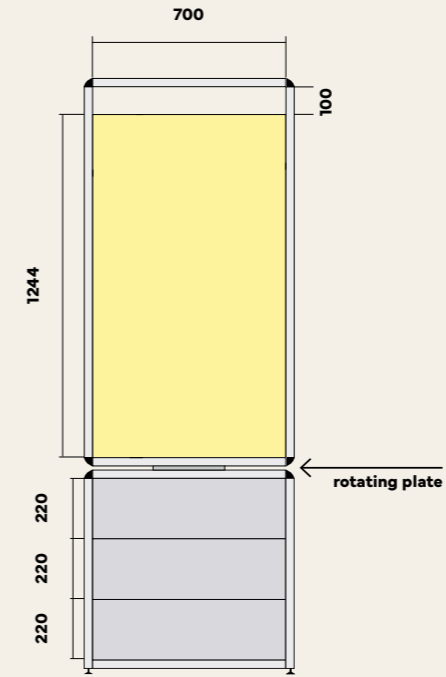

Cube, rotatable	
Dimensions (WxH)	Order no.
500 x 2180 mm	VB-LC360-500
700 x 2180 mm	VB-LC360-700



CUBE



The Cubes have a standard height of 2204 mm. This height contains:

- Heading 100 mm
- Heading 40 mm
- Whiteboard 1244 mm

- Incl. customised headline
- Whiteboard quality
- Inscrutable with a board marker
- Available as column conversion

Customise the width and headings of your cube according to your individual requirements.

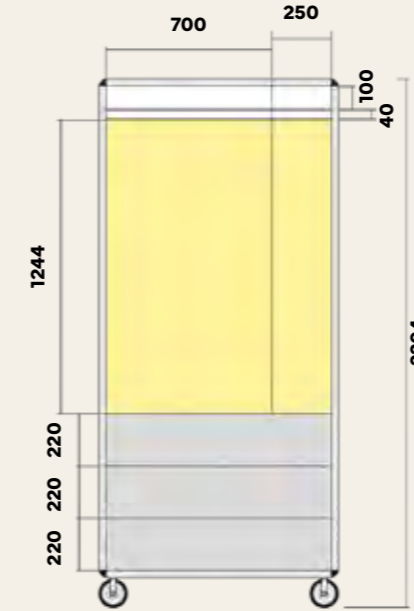

Cube	
Dimensions (WxH)	Order no.
500 x 2204 mm	VB-LC-500
700 x 2204 mm	VB-LC-700



STOP



Collect your KANBAN cards in one place. The stop serves as a clear indication or stopping point for your Milk Run (tugger train).

- Individual stop symbol
- Customised timetable display

Primus viewing compartment (p. 166) is not included in the price.
Optionally available in different sizes.

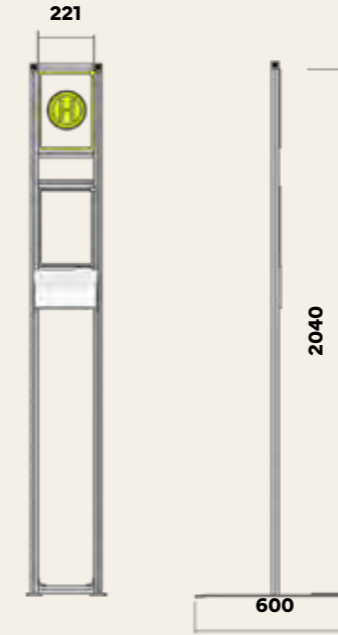

Stop	
Dimensions (WxH)	Order no.
600 x 2040 mm	VB-ST-HALT



ACCESSORIES

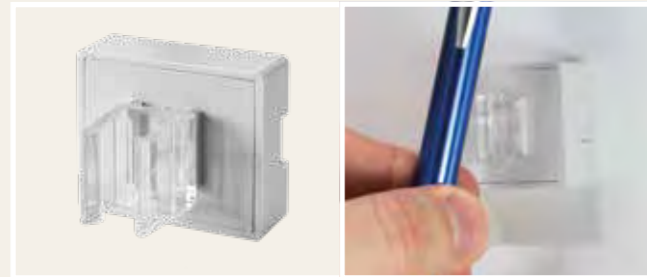

Pen holder, magnetic

Order no.	
VB-SH-MA	
Magnetic holder for pens/board markers with a maximum diameter of 12 mm.	



Magnetic signs for value stream symbols

Designation	Order no.	Dimensions (WxH)	Inlay (ET)	Pack
Large	HE148-105	105 x 148 mm	ET105-148	50 pcs.
Small	HE547-75	75 x 47 mm	ET475	50 pcs.
Inlay (ET), white	ET105-148	105 x 148 mm		40 pcs.
Inlay (ET), white	ET475	75 x 47 mm		120 pcs.

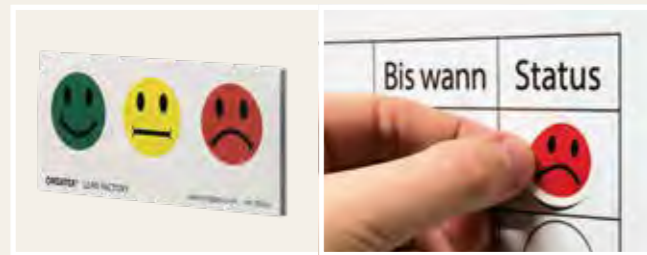

Sticker pad Smiley, self-adhesive

Order no.	Blocks	Pack
VB-ZB001	20 pcs.	1200 pcs.
Smiley sticker for labelling the corresponding status. Sticker diameter 30 mm.		



Smiley magnets, magnetic

Designation	Order no.	Dimensions	Colour	Pack
Sad	VB-HMS-01	Ø 36 mm	Red	10 pcs.
Neutral	VB-HMS-04	Ø 36 mm	Yellow	10 pcs.
Smiling	VB-HMS-05	Ø 36 mm	Green	10 pcs.

Smileys printed on plastic-coated magnets. High adhesive force and a good symbolic effect.

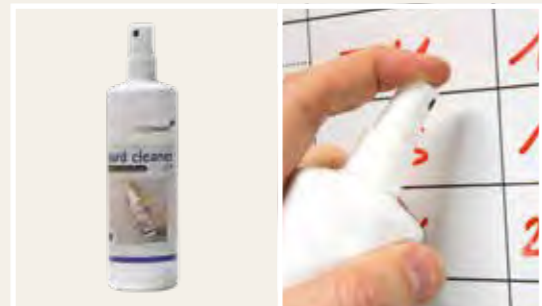

Board Cleaner

Order no.	
VB-WR	
<ul style="list-style-type: none"> - Cleaning spray for whiteboards - Quick drying - For removing dried-on residues - Without propellant - Contents of bottle: 250 ml 	



Board marker

Order no.	Pack
VB-WS4	4 pcs.
<ul style="list-style-type: none"> - Easy to wipe off all whiteboard surfaces - For whiteboards and flipcharts - Case with 4 pre-sorted colours: black, red, blue and green - Neatly refillable 	



Holder for board marker, magnetic

Order no.	
VB-SH4-MA	
<ul style="list-style-type: none"> - For all magnetic whiteboards - Magnetic - Capacity for up to 4 board markers 	



Board Assistant, magnetic

Designation	Order no.	Pack
Board Assistant	VB-BA-MA	1 pc.
Wiper refill pack	VB-LP	100 pcs.
<ul style="list-style-type: none"> - For all magnetic whiteboards - Magnetic storage box - Capacity for up to 7 board markers - Lid serves as a board wiper 		



File storage

Order no.	
VB-ZB002	
<ul style="list-style-type: none"> - For attaching to our aluminium profiles (visual boards) - Suitable for filing folders - Creates space, folders are immediately to hand 	



Whiteboard printing

We print customised whiteboards in-house, z. e.g. with a matrix or tables. Protected behind a coating, these are also protected against daily labelling/wiping or board-cleaning liquids.



DOCU MENT HOLDER

Be it work instructions, machine running times, tigger train schedules or maintenance and inspection logs – all documents that are important for operation must be displayed securely and transparently. Depending on the business and area of application, external influences such as dust, high humidity or oily air must be taken into account and the documents must be protected.



[katalog.orgatex.com/
dokumentenhalter](https://katalog.orgatex.com/dokumentenhalter)

Magnetic Windows	220
Magnetic-Windows-Frame	221
Magnetic-Windows-Headline	222
Multi Windows	223
Clipboard	224
FLIP-MAG	225

At ORGATEX® you will find a wide range of solutions for securely displaying your important documents with minimal effort and replacing them easily. Our document holders adhere to various surfaces, e.g. all smooth surfaces made of metal, glass or plastic. Our Magnetic Windows are available in various formats and colours. They have 3 magnetic and one self-adhesive side and can therefore be fixed permanently. The document windows can be written on so that, for example, machine running times can be noted without removing the document. In combination with our Magnetic Windows Headlines, they provide an overview of the processes. In addition to the magnetic windows, our portfolio also

includes the Multi Windows document holder, which adheres to smooth surfaces and can be used several times.

If several A4 pages are to be displayed in ring binder form, our FLIP-MAG programme with a special neodymium magnet is used. Lastly, the clipboard is an essential part of everyday business life and can also be ideally combined with the Magnetic Windows and placed on boards.



INFOGRAPHIC DOCUMENT HOLDER

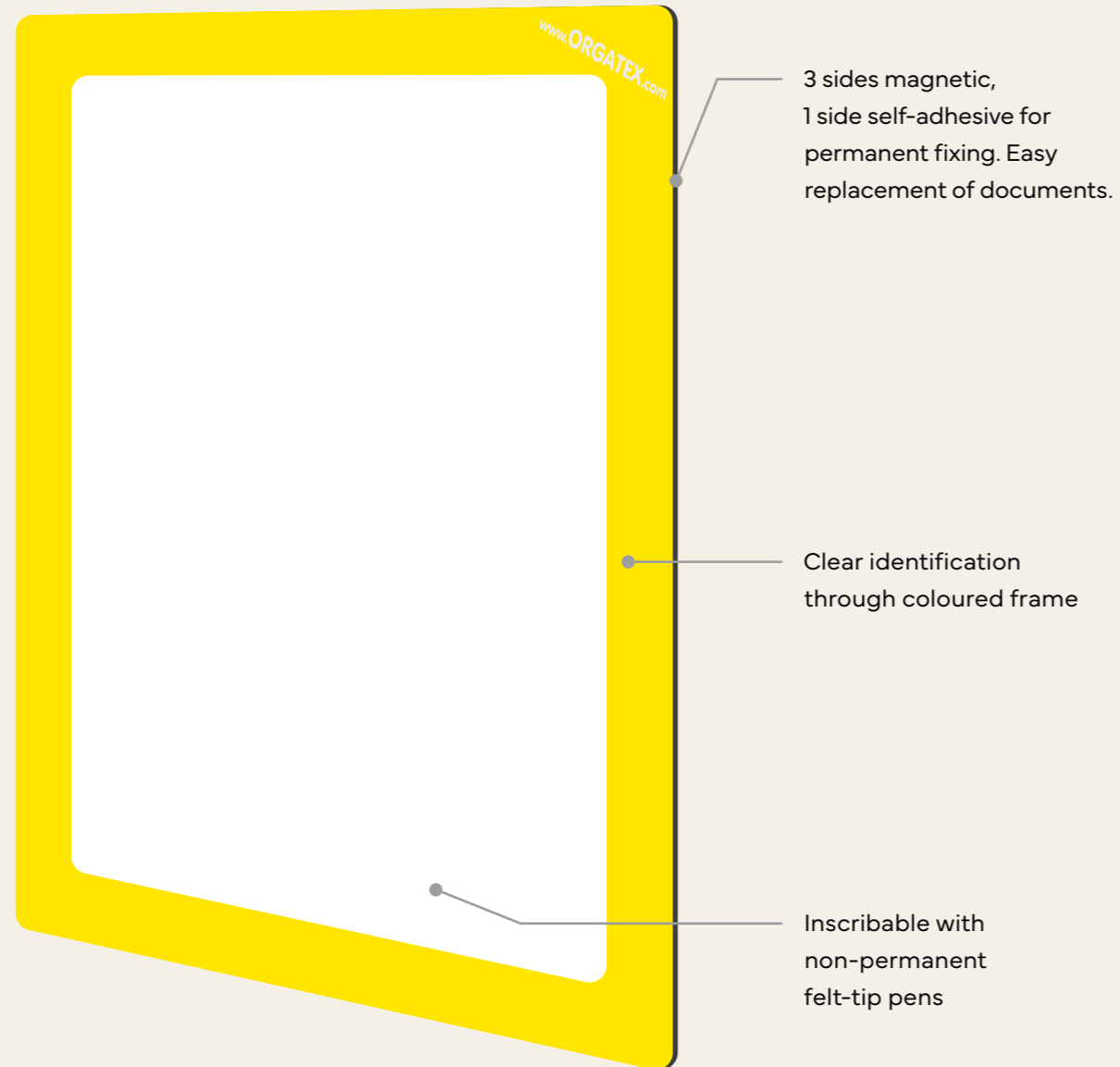

Adheres to
almost all
surfaces



For flexible
or perma-
nent labelling



Documents are
protected from
dirt and weather
conditions



Clipboard

With additional rubber coating on the clamp, provides an optimum hold for all types of documents. The robust metal clamp has a high clamping effect. Up to 60 sheets can be clamped.



MAGNETIC WINDOWS



- Coloured document windows
- Simple replacement of documents
- Permanent fixation possible with adhesive strips
- Inscrutable (with non-permanent felt-tip pens)
- Simple identification with coloured frames

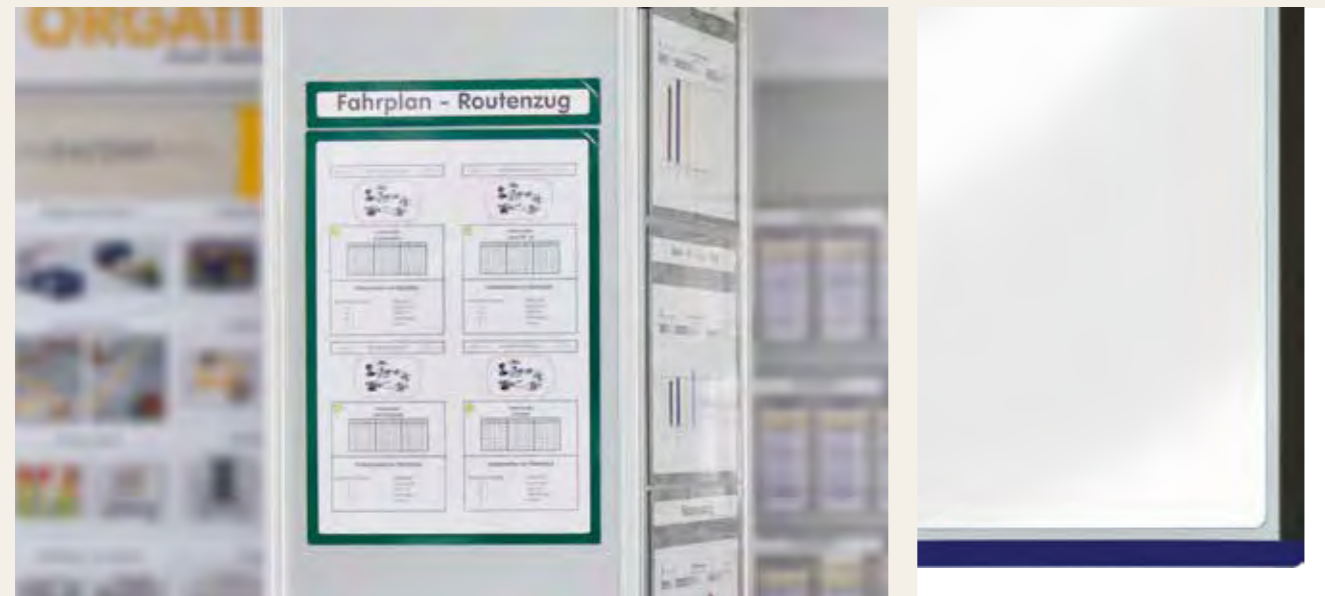

Magnetic Windows

Format	Dimensions inner/outer (W x H) (mm)/(in)	Order no.	+ Colour code	Pack
DIN A5 landsc.	210 x 148/235 x 173	KAN-MW-A5Q-	01 03 04 05 08 88	10 pieces
DIN A4 portr.	210 x 297/235 x 322	KAN-MW-A4H-	01 03 04 05 08 88	10 pieces
DIN A4 landsc.	297 x 210/322 x 235	KAN-MW-A4Q-	01 03 04 05 08 88	10 pieces
DIN A3 portr.	297 x 420/322 x 445	KAN-MW-A3H-	01 03 04 05 08 88	10 pieces
DIN A3 landsc.	420 x 297/445 x 322	KAN-MW-A3Q-	01 03 04 05 08 88	10 pieces
DIN A2 portr.	420 x 594/445 x 620	KAN-MW-A2H-	01 03 04 05 - 88	1 piece
DIN A2 landsc.	594 x 420/620 x 445	KAN-MW-A2Q-	01 03 04 05 - 88	1 piece
DIN A1 landsc.	841 x 594/865 x 620	KAN-MW-A1Q-	01 03 04 05 - 88	1 piece
LETTER portr.	8,50 x 11,00/9,50 x 12,00	KAN-MWEX-A4H-	01 03 04 05 - 88	10 pieces
LETTER landsc.	11,00 x 8,50/12,00 x 9,50	KAN-MWEX-A4Q-	01 03 04 05 08 88	10 pieces
LEDGER landsc.	17,00 x 11,00/18,00 x 12,00	KAN-MWEX-A3Q-	01 03 04 05 - 88	10 pieces
Arch. C landsc.	22,00 x 17,00/23,00 x 18,00	KAN-MWEX-A2Q-	- 03 - - - 88	1 piece



MAGNETIC-WINDOWS-FRAMES



Document holder for direct labelling of documents, e.g. for recording machine running times or creating maintenance and inspection logs.

- Frame for documents to be labelled directly
- Simple replacement of documents
- Permanent fixation possible with adhesive strips
- Simple identification with coloured frames

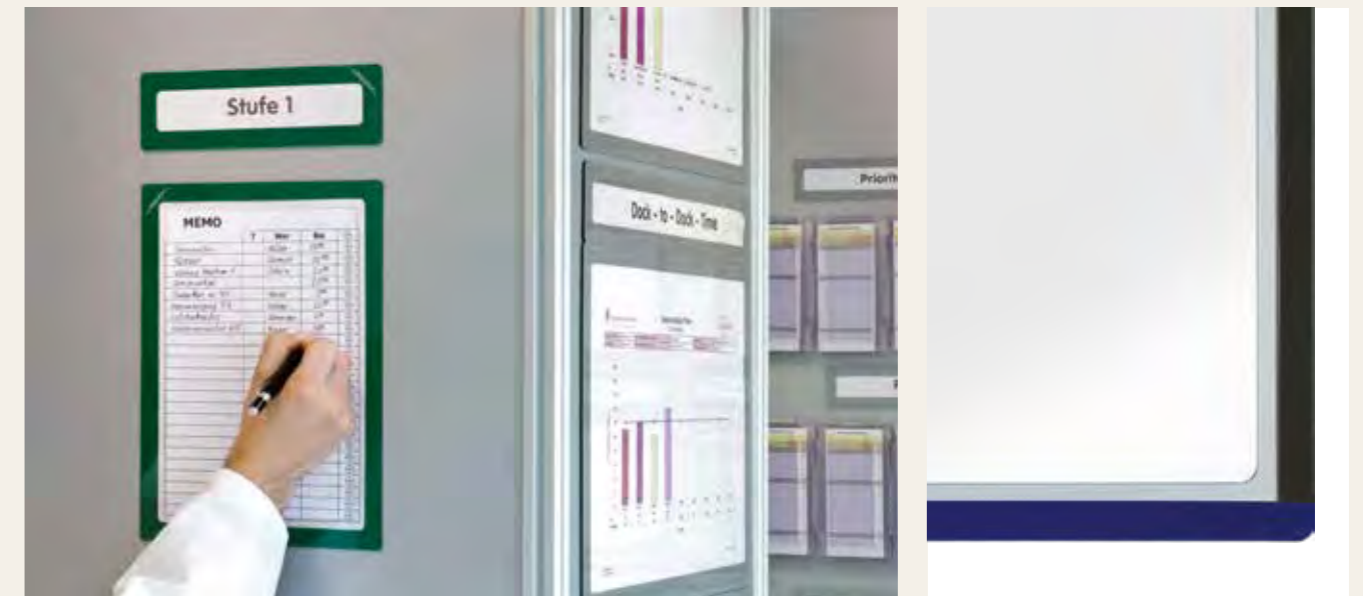

Magnetic-Windows-Frames

Format	Dimensions inner/outer (W x H) (mm)/(in)	Order no.	+ Colour code	Pack
DIN A4 portr.	210 x 297/234 x 321	KAN-MWR-A4H-	01 03 04 05 08 88	10 pieces
DIN A4 landsc.	297 x 210/321 x 234	KAN-MWR-A4Q-	- - - - - 88	10 pieces
DIN A3 portr.	297 x 420/321 x 444	KAN-MWR-A3H-	- - - - - 88	10 pieces
DIN A3 landsc.	420 x 297/444 x 321	KAN-MWR-A3Q-	- - - - - 88	10 pieces
LETTER	205,00 x 268,50/239,00 x 302,50	KAN-MWREX-A4Q-	01 03 04 05 08 88	10 pieces
LEDGER	268,50 x 421,00/302,50 x 455,00	KAN-MWREX-A3Q-	01 03 04 05 08 88	10 pieces



MAGNETIC-WINDOWS-HEADLINE



- Simple replacement of documents
- Permanent fixation possible with adhesive strips
- Inscrutable (with non-permanent felt-tip pens)
- Simple identification with coloured frames



Magnetic-Windows-Headline

Format	Dimensions inner/outer (W x H) (mm)/(in)	Order no.	+ Colour code	Pack
DIN A4 portr.	210 x 48/235 x 70	KAN-MWH-A4H-	01 03 04 05 08 88	10 pcs.
DIN A4 landsc.	297 x 48/322 x 70	KAN-MWH-A4Q-	01 03 04 05 08 88	10 pcs.
DIN A3 landsc.	420 x 48/445 x 70	KAN-MWH-A3Q-	01 03 04 05 08 88	10 pcs.
LETTER portr.	8,50 x 1,80 in/9,50 x 2,80	KAN-MWHEX-A4H-	01 03 04 05 - 88	10 pcs.
LETTER landsc.	11,00 x 1,80 in/12,00 x 2,80	KAN-MWHEX-A4Q-	01 03 04 05 - 88	10 pcs.
LEDGER landsc.	17,00 x 1,80 in/18,00 x 2,80	KAN-MWHEX-A3Q-	01 03 04 05 - 88	10 pcs.

MULTI WINDOWS



- All-round adhesive frame
- Removable without residue
- Repositionable (can be re-glued)
- Multiple use
- Adheres to smooth surfaces (e.g. glass, metal, plastic)
- No electrical charging
- Inscrutable with non-permanent felt-tip pens

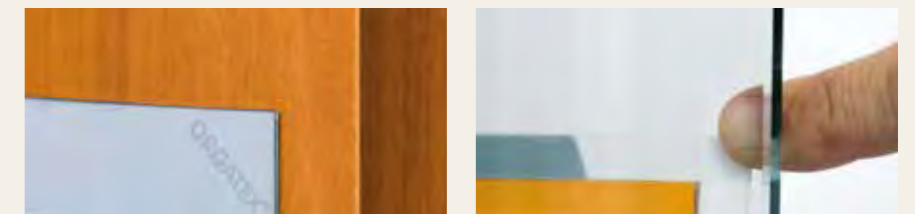
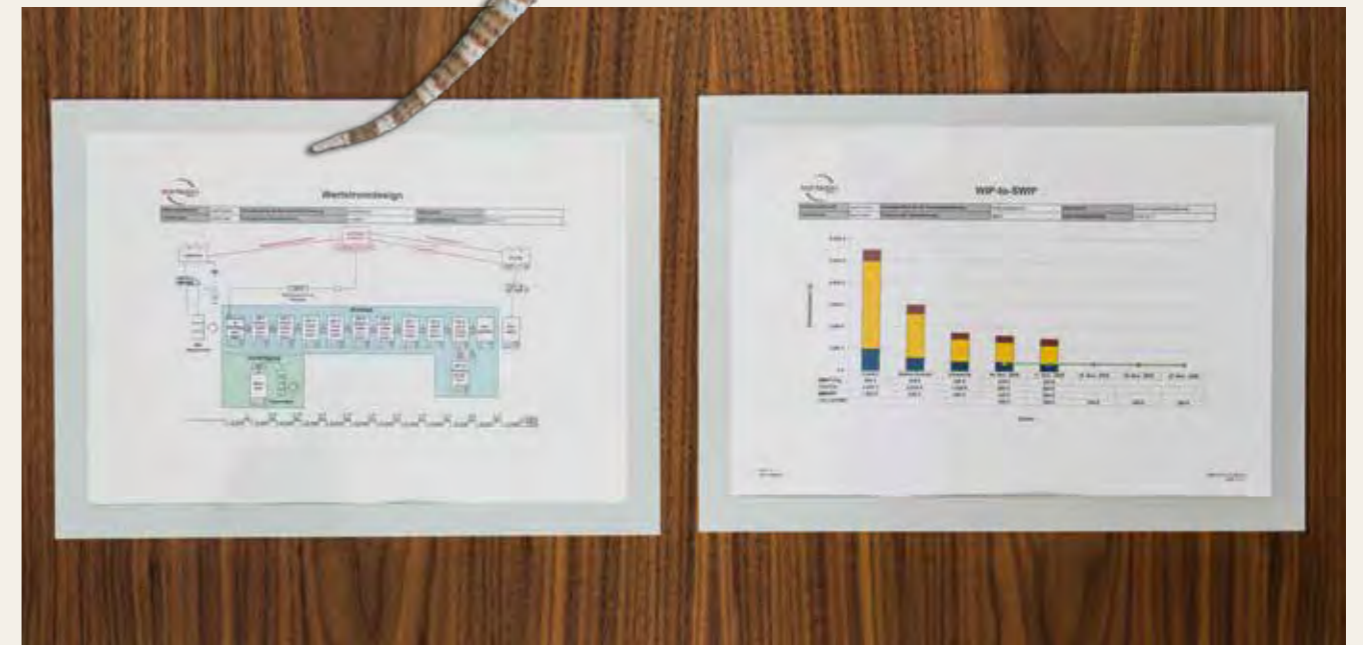

Multi Windows

Format	Dimensions inner/outer (W x H) (mm)	Order no.	+ Colour code	Pack
DIN A4 portr.	212 x 300/ 231 x 318 (mm)	KAN-MU-A4-	01 03 04 05 08 88	10 pieces
DIN A5 portr.	151 x 212/ 169 x 231 (mm)	KAN-MU-A5-	- - - - - 88	10 pieces
DIN A3 portr.	298 x 422/ 318 x 441 (mm)	KAN-MU-A3-	- - - - - 88	10 pieces



CLIPBOARD



The clipboard is the ideal helper when there is no firm writing surface available. The additional rubber grip on the clamp provides an optimum hold for all types of documents. Thanks to its standardised size, it is ideal for combining with the Magnetic Windows and placing on boards.

- Robust metal clamp with high clamping effect
- Up to 60 sheet capacity
- Durable plastic (polystyrene)
- Rubberised clamp for a particularly secure hold

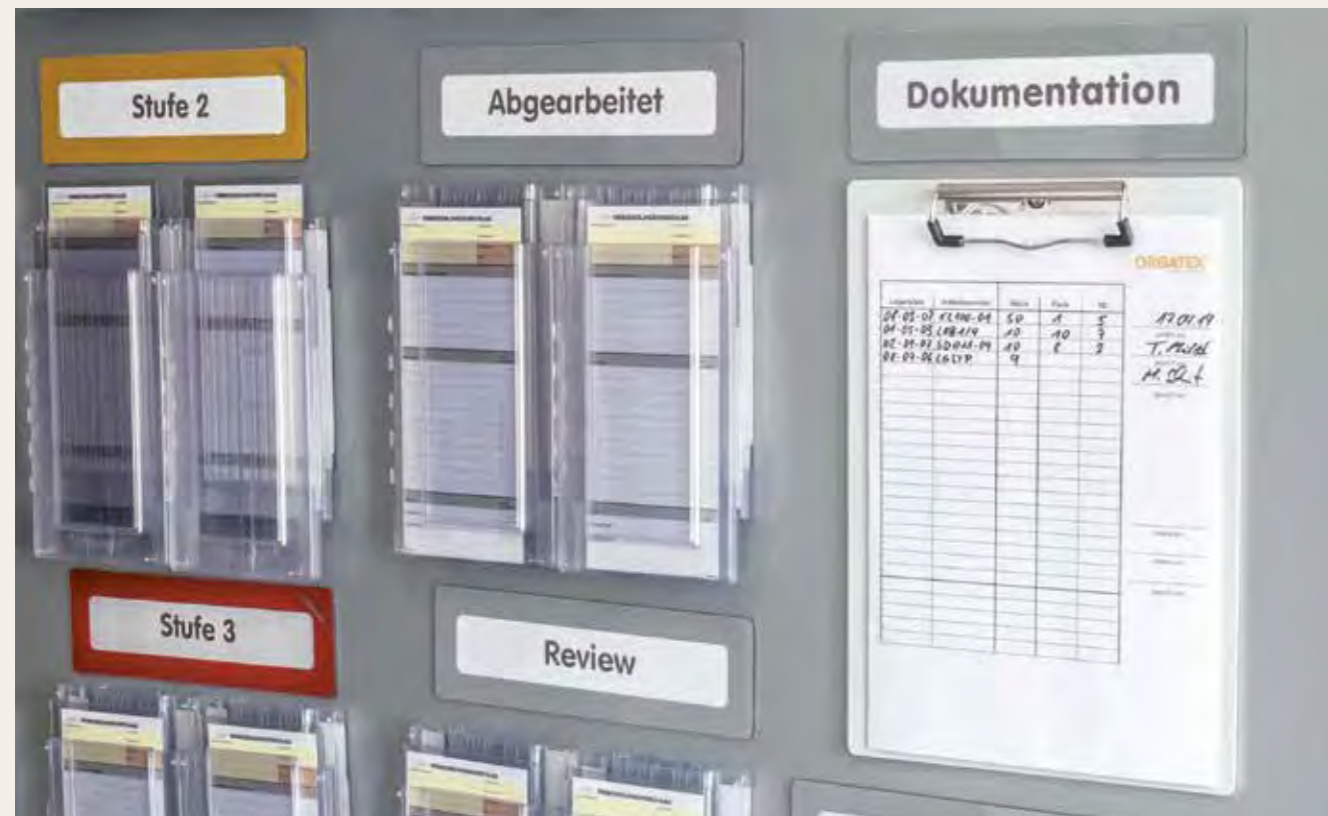

Clipboard

Format	Dimension (W x H) (mm)	Order no.	Pack
DIN A4 portr.	234 x 321	VB-KB-A4H-88	2 pieces
DIN A4 landsc.	321 x 234	VB-KB-A4Q-88	2 pieces
DIN A4 portr., magnetic	234 x 321	VB-KBM-A4H-88	2 pieces
DIN A4 landsc., magnetic	321 x 234	VB-KBM-A4Q-88	2 pieces



FLIP-MAG



Sleeves with filing margin und strong adhesive neodymium magnets for documents in DIN A4 format vertical or horizontal. Double ended document insertion.

- Can be used on both sides
- For use with our ring binder mechanism
- Can be used in landscape and portrait format
- 4 hole perforation



FLIP-MAG

Designation	Order no.	+ Colour code	Pack
FLIP-MAG (sleeves)	FLIP-MAG-	01 03 04 05 07 -	10 pieces
FLIP-MAG-ESD-version	FLIP-MAG-ESD-	- - - - - 20	10 pieces
Ring binder mechanism, magnetic	RBM-MA-35		1 piece



ELEC TRO STATIC DIS CHARGE

Do you work with electrostatically sensitive assemblies or components? In this case, we have developed special versions of our popular products that cannot become electrostatically charged. For example, we work with special PVC films that permanently dissipate any charges that arise. This ensures that none of your products are damaged or completely destroyed during your storage processes.



[katalog.orgatex.com/
esd](https://katalog.orgatex.com/esd)

Visual pockets	From 230
ESD visual pockets for attaching	230
Fasteners for visual pockets	231
Fasteners for visual pockets ESD	231
Visual pockets ESD, super-magnetic	234
Document holder	From 235
KANBAN-Cover ESD for overhanging	235
KAN-Label ESD	236
KLT-Snapper-ESD-KANBAN-sleeves	237
Receipt holder	From 238
FLIP-MAG ESD	238
Work document sleeve ESD, type Primus	239
Insertion systems	From 240
Systembox ESD (low-charging)	240
Accessories Systembox ESD	241
KANBAN-letterbox ESD (low-charging)	242
Floor marking	From 243
Floor identification sign „ESD“	243
LongLife floor marking tape „ESD“	244
Dollies	245
ESD Dollies, 600 x 400 mm	245

Did you know? This is what ESD means!

Electrostatic charges (electrostatic discharge) can be absorbed and released by the human body. These charges are generated by friction and the subsequent separation of two objects. A particularly strong charge

can even cause visible sparks. A discharge that can be felt by humans is approx. 3000 volts, whereas 30 volts is sufficient to destroy an electrostatically sensitive component or an electrostatically sensitive assembly.



INFOGRAPHIC ESD-PRODUCTS

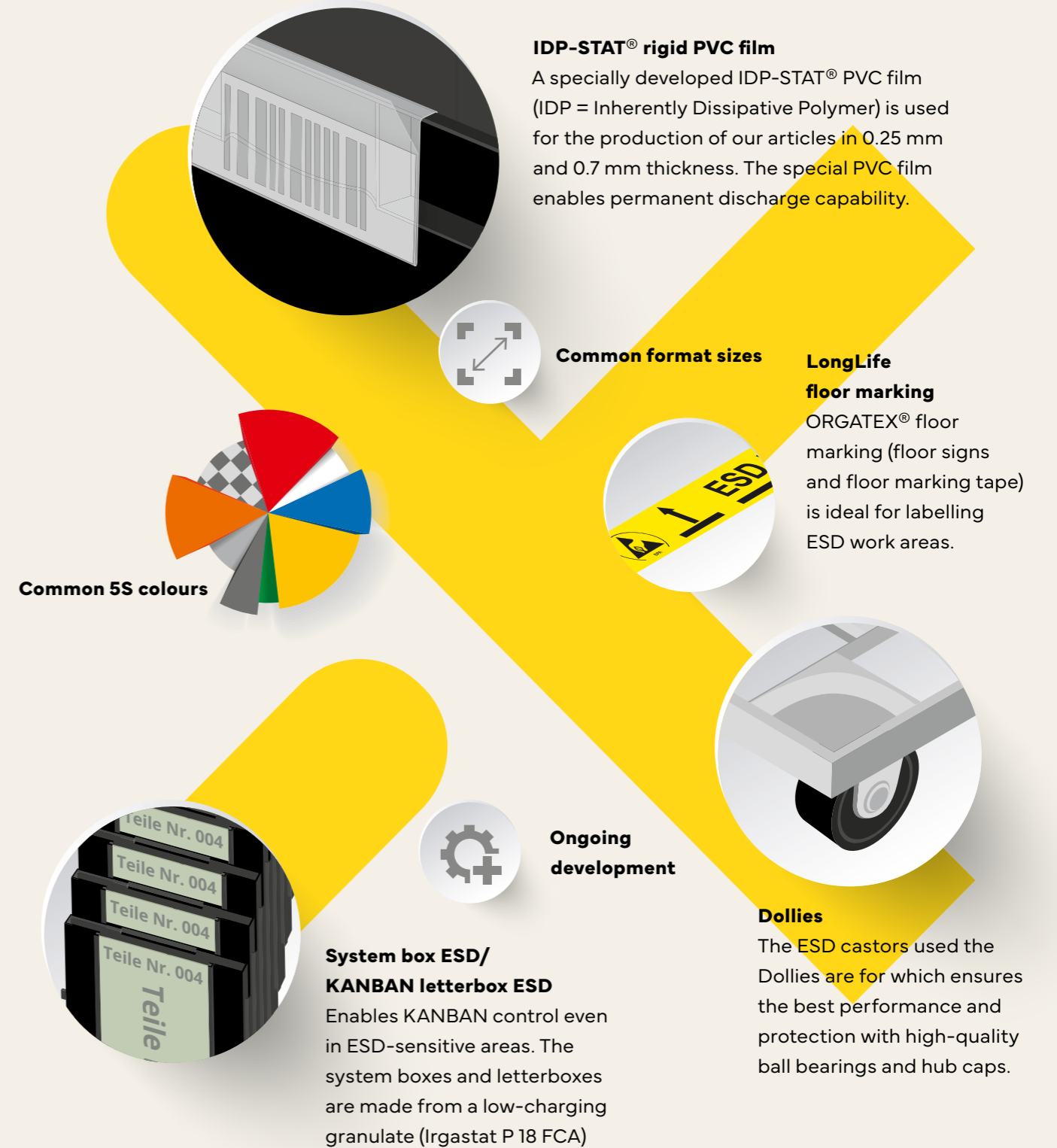
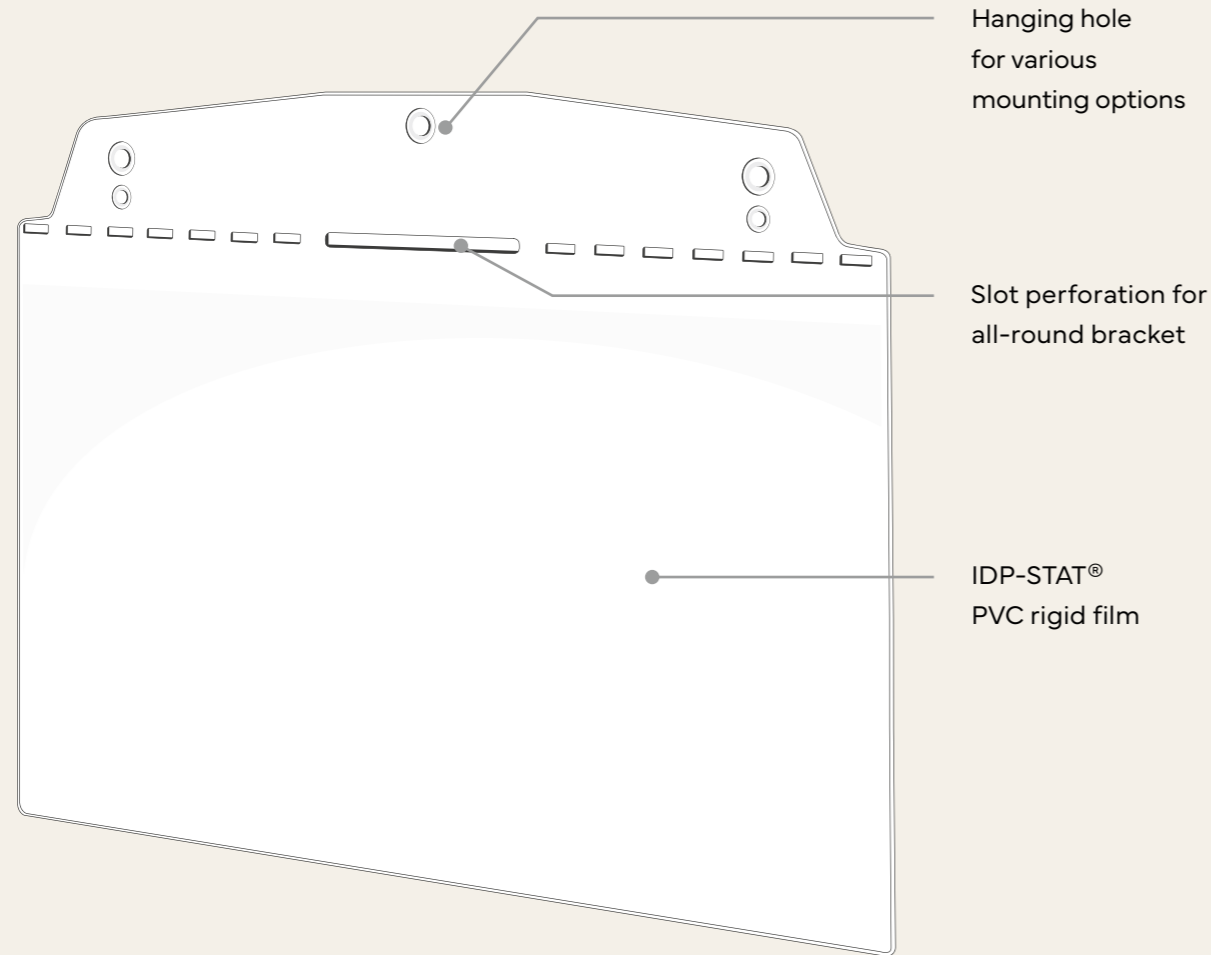

Wide Product range



For working areas with electrostatic discharges



Meets the requirements of DIN EN 61340-5-1



VISUAL POCKETS ESD FOR ATTACHING



In many cases, there is no suitable surface on containers for labelling. This can be remedied with the hanging visual pocket. It consists of hard-wearing plastic, a reinforced top section and a transparent viewing window for documents. Thanks to our extensive range of accessories, labelling is possible on almost any surface.

- Permanently dissipative
- Made from Inherently Dissipative Polymer (IDP)
- Complies with the requirements of DIN EN 61340-5-1
- Film thickness: 0.25 mm
- Recyclable
- Scanner compatible

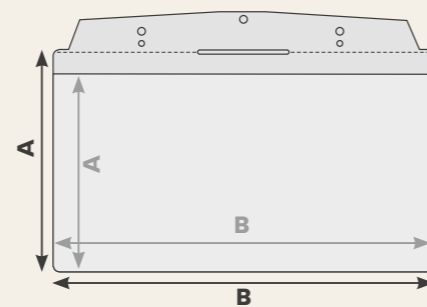

Available formats in mm, outer dimension/inner dimension

	1/3	A7 landsc.	A6 landsc.	A5 landsc.	A5 portr.	A4 landsc.	A4 portr.
A	160/108	112/70	159/111	205/152	264/217	268/217	335/328
B	230/225	115/112	159/156	230/225	160/153	325/322	229/225



ESD visual pockets for attaching

Format	Order no.	+ Colour code	Pack
DIN A7 landsc.	SD011-ESD-	01 02 03 04 05 06 07 08 20	10 pieces
DIN A6 landsc.	SD012-ESD-	01 02 03 04 05 06 07 08 20	10 pieces
1/3 DIN	SD016-ESD-	01 02 03 04 05 06 07 08 20	10 pieces
DIN A5 landsc.	SD013-ESD-	01 02 03 04 05 06 07 08 20	10 pieces
DIN A5 portr.	SD015-ESD-	01 02 03 04 05 06 07 08 20	10 pieces
DIN A4 portr.	SD018-ESD-	01 02 03 04 05 06 07 08 20	10 pieces
DIN A4 landsc.	SD020-ESD-	01 02 03 04 05 06 07 08 20	10 pieces



FASTENERS FOR VISUAL POCKETS ESD



All-round bracket (patented)

Order no.	Pack
KTB3000	10 pieces

The patented all-round bracket for quick insertion into our pockets with slot perforation in the top section. Designed for pallet cages and/or thick-walled containers up to 4 cm. Dimensions (WxH): 215 x 125 mm.

The all-round bar **cannot be used** with:

- Pocket design with protective flap
- DIN A7, DIN A4 landscape



Special retaining bracket

Order no.	Pack
MA2000	10 pieces

Made of black coated spring steel wire with rounded ends. The special retaining bracket is pulled through the two outer suspension holes of the visual pocket. Thanks to the spring steel design, it sits firmly between rods or cardboard boxes, on wire pallet cages etc. This bracket can be slipped over, inserted and attached in between by turning.

Dimensions (WxH): 320 x 100 mm.

Particularly suitable for DIN A4 landscape, cannot be used for DIN A6 landscape and DIN A5 portrait.

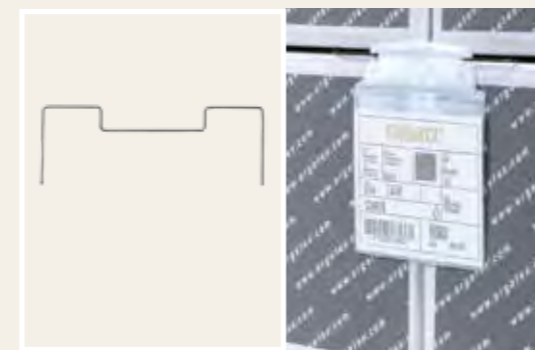

Mini special bracket

Order no.	Pack
MA2080	10 pieces

The mini special bracket made of spring steel wire was designed for fastening smaller pocket formats (DIN A6 horizontal, DIN A5 vertical). Secure hold on cardboard boxes, containers, pallet cages etc. This bracket can be slipped over, inserted and attached in between by turning. Dimensions (WxH): 230 x 80 mm.

Only suitable for DIN A6 landscape and DIN A5 portrait.



Container bracket

Order no.	Pack
MA2090	10 pieces

Made of black coated spring steel wire with rounded ends. This flexible attachment is particularly recommended for thick-walled containers with a wall thickness of up to 2 cm. Dimensions (WxHxD): 170 x 65 x 21 mm.

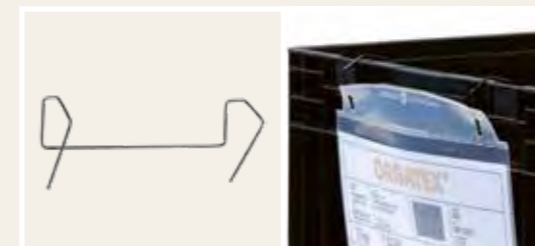

Container bracket

Order no.	Pack
MA2100	10 pieces

Made of black coated spring steel wire with rounded ends. This flexible attachment is particularly recommended for thick-walled containers with a wall thickness of up to 5 cm. Dimensions (WxHxD): 170 x 65 x 45 mm.



FIXTURES FOR VISUAL POCKETS ESD



U-clamps (patented)

Order no.	Pack
MA2030	50 pieces

For attaching pockets/sleeves to all types of pallet cages. The special bending enables easy removal.
Dimensions (WxH): 28 x 55 mm.



U-clamps

Order no.	Pack
MA2020	50 pieces

For piercing cardboard, film and other outer packaging and when using small pocket formats (DIN A7/DIN A6).
Dimensions (WxH): 15 x 38 mm.



Plastic spike

Order no.	Pack
MA2060	50 pieces

For piercing soft materials such as cardboard, film, plastic bags, textiles, etc. Length: 12 mm.

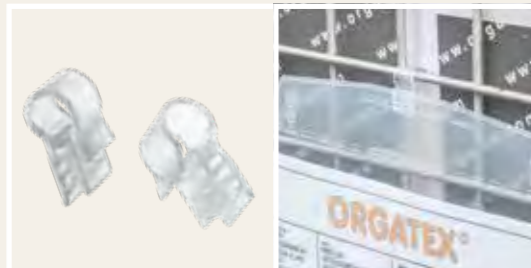

Gripper

Order no.	Pack
KAN-GRIPPER	100 pieces

For hanging on pallet cages, the bag clamps in the holder.



U-Gripper

Order no.	Pack
KAN-U-GRIPPER	100 pieces

For overhanging, e.g. on pallet cages, with 2 parallel hooks and wide pocket clip.



FIXTURES FOR VISUAL POCKETS ESD



Plastic binder

Order no.	Pack
MA2050	50 pieces

Plastic ties are highly recommended if the bags are to be permanently attached or, for example, attached to profiles, cables or similar. The special fastener allows multiple use. Length: 320 mm.



VST-Gripper

Order no.	Pack
VST-GRIPPER	50 pieces

The round tube label holder makes it easy to flexibly attach visible pockets or label holders to round tubes with a diameter of 28 - 30 mm. The grip points on the inside prevent slipping when fitting or removing the labelling.

The toothed mount provides a secure hold even in the event of vibration.

For the development of an ESD control programme and the establishment of ESD protection zones (Electrostatic Discharge Protected Area, EPA), it is recommended that the following international standards be used as a guide:

DIN EN 61340-5-1

Electrostatics - Part 5-1: Protection of electronic components against electrostatic phenomena - general requirements (2008-07)

DIN EN 61340-5-1 Supplement 1

Electrostatics - Part 5-2: Protection of electronic components against electrostatic phenomena - user manual (2009-09)

DIN EN 61340-5-3 NEW

Electrostatics - Part 5-3: Protection of electronic components against electrostatic phenomena - characteristics and requirements for the classification of packaging used for components sensitive to electrostatic discharge. (2011-05)

IDP-STAT®-PVC-Film

- Permanently dissipative
- Made from Inherently Dissipative Polymer (IDP)
- Complies with the requirements of DIN EN 61340-5-1
- Colour: transparent
- Film thickness: 0.25 mm and 0.7 mm
- Recyclable

Product qualification according to DIN EN 61340-5-1 (2008-07):

	Test method	Limit values	Typical values
Surface resistance R_s	DIN EN 61340-2-3	$1 \times 10^5 \leq R_s < 1 \times 10^{11} \Omega$	109 - 1010 Ω
Ambient conditions: 12 ± 3 % relative humidity and 23 ± 2 °C (conditioning > 48 hours)			



VISUAL POCKETS ESD SUPER-MAGNETIC



The high-quality, super-magnetic ESD visual pockets are the ideal solution in the event of strong shocks or vibrations during transport. With 2 super-strong, welded-in neodymium magnets, this pocket has been specially developed for attaching to ferrous surfaces or curved and uneven surfaces. They are made of IDP-STAT® rigid PVC film with a reinforced head section.

- Permanently dissipative
- Made from Inherently Dissipative Polymer (IDP)
- Complies with the requirements of DIN EN 61340-5-1
- Film thickness: 0.25 mm
- Recyclable
- Scanner compatible

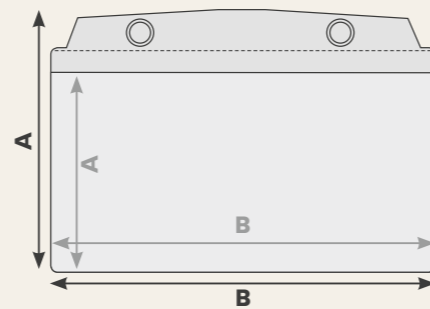

Existing formats in mm Outer dimension/inner dimension

	A6 landsc.	A5 landsc.	A4 landsc.	A4 portr.
A	159/111	205/152	268/217	335/328
B	159/156	230/225	325/322	229/225

ESD visual pockets, super-magnetic

Format	Order no.	+ Colour code	Pack
DIN A6 landsc.	MU2260-ESD-	01 02 03 04 05 06 07 08 20	10 pieces
DIN A5 landsc.	MU2250-ESD-	01 02 03 04 05 06 07 08 20	10 pieces
DIN A4 portr.	MU2240-ESD-	01 02 03 04 05 06 07 08 20	10 pieces
DIN A4 landsc.	MU2230-ESD-	01 02 03 04 05 06 07 08 20	10 pieces



KANBAN-COVER ESD FOR OVERHANGING



The high-quality KANBAN cover made of IDP-STAT® rigid PVC film is ideal for labelling different load carriers in the ESD area. It can be used both for standard containers and as a customised solution.

- Permanently dissipative
- Made from Inherently Dissipative Polymer (IDP)
- Complies with the requirements of DIN EN 61340-5-1
- Colour: milky, transparent
- Film thickness: 0.7 mm
- Recyclable



Order no.	Format	Outer dimension (WxHxT) (mm)	Pack
KAN-COW1/4DIN-ESD	1/4 DIN	215 x 80 x 16	10 pieces



KAN-LABEL ESD

The ESD-KANBAN sleeves have been developed to fit KLT containers and Euroboxes perfectly. They are made of IDP-STAT® rigid PVC film and ensure a secure hold, even under load. Their size makes them ideal for use in ORGATEX® KANBAN boards.



- VDA standard 4902
- Permanently dissipative
- Made from Inherently Dissipative Polymer (IDP)
- Complies with the requirements of DIN EN 61340-5-1
- Colour: slightly milky, transparent
- Film thickness: 0.25 mm
- Recyclable
- Scanner compatible
- Closed on 3 sides, side insert



KAN-Label ESD

Order no.	Dimension inner/outer (WxH) (mm)	Inlay	Pack
KL100-ESD-20	200 x 67/209 x 80	ET670	50 pieces
KAN-LABEL1/3DIN-ESD-20	200 x 85/209 x 99	ET85	50 pieces
KAN-LABELA5-ESD-20	200 x 135/209 x 147	ET135	50 pieces

Cardboard inserts (inlays) Page 83



KLT-SNAPPER-ESD-KANBAN-SLEEVES

The ESD-KANBAN sleeves have been developed to fit KLT containers and Euroboxes perfectly. They are made of IDP-STAT® rigid PVC film and ensure a secure hold, even under load. Their size makes them ideal for use in ORGATEX® KANBAN boards.



- VDA standard 4902
- Permanently dissipative
- Made from Inherently Dissipative Polymer (IDP)
- Complies with the requirements of DIN EN 61340-5-1
- Colour: slightly milky, transparent
- Film thickness: 0.25 mm
- Recyclable
- Scanner compatible
- Closed on 3 sides, top insert



KLT-Snapper-ESD-KANBAN sleeves

Order no.	Dimension inner/outer (WxH) (mm)	Inlay	Pack
KLT-SNAP-ESD/20	200 x 67/209 x 80	ET670	50 pieces
KLT-SNAP-1/3DIN-ESD/20	200 x 85/209 x 99	ET85	50 pieces
KLT-SNAP-DINA5-ESD/20	200 x 135/209 x 147	ET135	50 pieces

Cardboard inserts (inlays) Page 83



FLIP-MAG ESD



Due to the viewing window on the front and back the specially reinforced IDP-STAT® rigid PVC film can be used on both sides. It is suitable for use in ring binder mechanisms with special neodymium magnets for horizontal and vertical page turning. FLIP-MAG is designed for documents in DIN A4 format vertical or horizontal and ensures secure hold.

- Can be used on both sides
- Especially for use with the ring binder mechanism
- Permanently dissipative
- Made from Inherently Dissipative Polymer (IDP)
- Complies with the requirements of DIN EN 61340-5-1
- Colour: slightly milky, transparent
- Film thickness: 0.25 mm
- Recyclable
- Scanner compatible



FLIP-MAG ESD

Order no.	Format	Dimension inner/outer (W x H) (mm)	Pack
FLIP-MAG-ESD-20	DIN A4	297 x 210/315 x 255	10 pieces
RBM-MA-35	Ring binder mechanism, magnetic		1 piece



WORK DOCUMENT SLEEVE ESD TYPE PRIMUS



Whether order documents or test reports. The ESD work document sleeve protects your documents from soiling.

- Permanently dissipative
- Made from Inherently Dissipative Polymer (IDP)
- Complies with the requirements of DIN EN 61340-5-1
- Colour: slightly milky, transparent
- Film thickness: back 0.7 mm, front 0.25 mm
- Side insert
- With welded-on business card pocket
- Recyclable
- Scanner compatible



Work Document Sleeve ESD, type Primus

Order no.	Format	Dimension inner/outer (WxH) (mm)	Pack
ATP660-ESD-20	DIN A4	215 x 305/240 x 316	10 pieces



SYSTEMBOX ESD (LOW-CHARGING)



The ESD system box is used to hold KANBAN cards. The structure can be slotted or in a block, so it can be extended as required.

- Material: ABS
- Low-charging
- Use in ESD-KANBAN boards



Systembox ESD (low-charging)

Order no.	Dimension inner/outer (W x H) (mm)	Pack
SYSB-ESD-06	118 x 190 x 6/122 x 192 x 10	10 pieces



ACCESSORIES SYSTEMBOX ESD

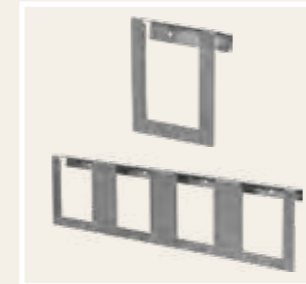

Bracket (stainless steel)

Order no.	Version	Format (WxH) (mm)
SYSB-WH-1	Bracket, single (stainless steel)	111 x 166
SYSB-WH-4	Bracket, 4-way (stainless steel)	486 x 166

- Equipped with holes for wall mounting or attachment to our greyboards
- The system boxes are stacked in columns of 1 or 4 on the wall bracket
- Incl. mounting material



Additional bracket (stainless steel)

Order no.	
SYSB-WH-U	

- The penultimate system box of a column can be fixed in place using the additional bracket



Adjustable base for system box

Order no.	Pack
SYSB-FH	50 pieces

- Adjustable in 5 mm increments
- System box can be adjusted to individual card size



Insert label, transparent, small

Order no.	Matching cardboard insert	Pack
SYSB-HE-35-ESD	ET33-75K	10 pieces
SYSB-HE-169-ESD	ET75-168K	10 pieces



Cardboard inserts

Order no.	+ Colour code	Suitable for	Cardboard inserts/Pack	Sheets DIN A4
ET33-75K-	01 02 04 05	SYSB-HE-35-ESD	160	10
ET75-168K-	01 02 04 05	SYSB-HE-169-ESD	30	10



KANBAN LETTERBOX ESD (LOW-CHARGING)



KANBAN letterbox supports the use of KANBAN cards and has a high filling capacity.

- High filling capacity (35 mm)
- Sufficient for up to 40 KANBAN cards
- For KANBAN cards according to VDA standard 4902
- Material: ABS
- Low-charging
- Wall mounting with 2 screws (not included)



KANBAN letterbox ESD (low-charging)

Order no.	Outer Dimension (WxHxD) (mm)	Pack
KN-BK-35-ESD-06	115 x 155 x 38	2 pieces



FLOOR MARKING SIGN „ESD“



ORGATEX® floor markings (signs) are ideal for labelling ESD work areas. Thanks to the newly developed plastic surface, the floor markings are slip-resistant, extremely hard-wearing, and wear-resistant.

- Made from PVC
- Full-surface self-adhesive backing
- Increases occupational safety
- Simple attachment
- Excellent adhesion
- High slip resistance (non-slip)
- Trafficable
- High warning and information effect



Floor Marking Sign „ESD“

Order no.	Outer Dimension (W x H) (mm)
LG-SCHILD-001-04	450 x 300



LONGLIFE FLOOR MARKING TAPE „ESD“



ORGATEX® floor markings are ideal for labelling ESD work areas. Due to the newly developed plastic surface, the floor markings are extremely hard-wearing and wear resistant.

- Simple attachment
- Forklift proof and scratch resistant
- High abrasion resistance
- Excellent adhesion
- Reference to ESD areas



LongLife Floor Marking Tape „ESD“

Order no.	Format (W x L) (mm)	Roll
LG50-ESD	50 x 50.000	1 Roll
LG75-ESD	75 x 50.000	1 Roll



DOLLIES ESD 600 X 400 MM



MAT-BORO-1/ESD
2 swivel- / 2 fixed castors (plastic)

MAT-BORO-2-ESD
4 swivel castors (plastic)

MAT-BORO-7B-ESD
2 swivel- / 2 fixed castors (plastic)
with drawbar

The solution along the logistics chain.
From the delivery of goods to dispatch.

- Compatible with Euro-size containers
- Suitable for tugger trains (drawbar depending on model)
- Extremely true to track
- Stackable
- With Easy-Lock system
- Manufactured in accordance with DIN ISO 9001/14001
- Suitable for transport on an adapter pallet

Further variants from page 251



Dollies ESD, 600 x 400 mm

Order no.	Designation	Swivel-/fixed castors	Width (mm)	Length (mm)
MAT-BORO-1/ESD	Dollies without drawbar	2/2	400	600
MAT-BORO-2-ESD4	Dollies without drawbar	4/-	400	600
MAT-BORO-7B-ESD	Dollies with drawbar	2/2	400	600

MATERIAL TRANSPORT

In order to save costs and remain competitive, in-house material supply must be organised as efficiently as possible. Tugger trains are becoming increasingly important due to the growing demand for flexible material supply. Containers of different sizes must be able to be transported at the same time to ensure that materials are available on demand. ORGATEX® offers you the optimum aids for this: floor rollers, shelf wagons, taxi wagons and adapter pallets.





[katalog.orgatex.com/
materialtransport](https://katalog.orgatex.com/materialtransport)

Dollies	From 250
Dollies, 400x400 mm	250
Dollies, 400x600 mm	ab 252
Dollies, 800x600 mm	258
Dollies, 800x1200 mm	260
Pallet dollies	From 262
Pallet dolly, 600 x 800 mm	262
Pallet dolly, 800 x 1200 mm	263
Pallet dolly accessories	264
Shelf wagon, 800 x 1200 mm	266
Taxi wagon for dollies	268
Adapter pallet for dollies	269
Lid	From 270
Lid with integrated belt system	270
Lid, lashing strap	271

Due to their size and flexibility, ORGATEX® dollies made of galvanised steel can be used in a much more space-saving manner than pallets and can also be replaced more quickly. They are available in various sizes, with different types of castors, both with and without a drawbar and also as pallet dollies – depending on your requirements. Our portfolio is rounded off by the adapter pallet, which has been specially developed for holding, storing and transporting dollies.

Our shelf wagon suitable for tugger trains has a frame with perforations, which makes it possible to allow the shelves to be adjusted or removed as required. Our taxi wagon is particularly useful for longer distances. Thanks to it, no further aids such as forklift trucks or pallet trucks are required for handling between the logistics train and the assembly site.

Discover our solutions and ensure synchronised material supply, reduced traffic, lower inventories and high supply reliability in your company!

INFOGRAPHIC MATERIAL TRANSPORT

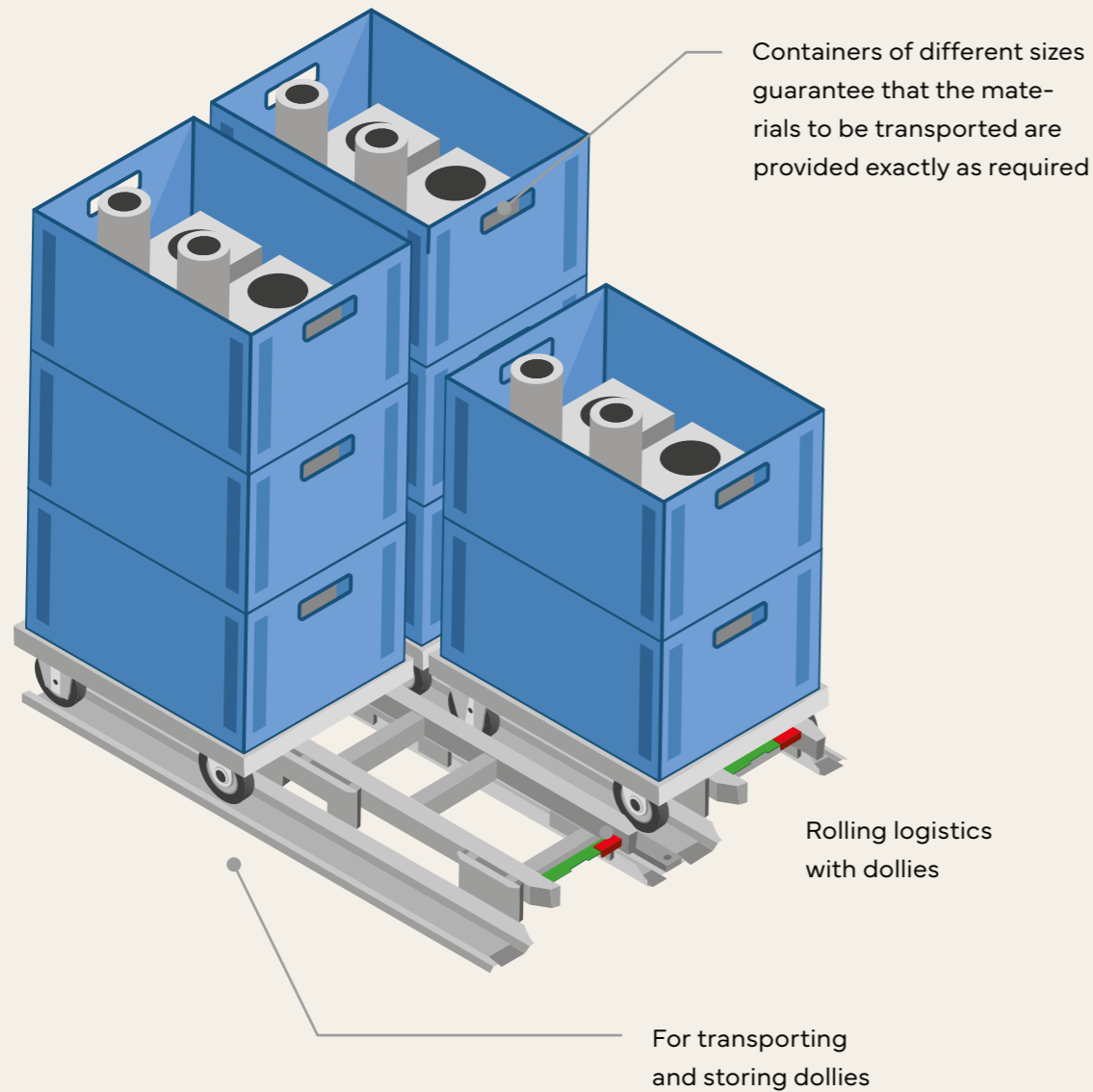

Flexible material supply



Transport of containers of various sizes



Supply with trolley train

Dollies
Dollies have 2 or 4 swivel castors, are compatible with Euro-sized containers and suitable for trolley trains. They are extremely directionally stable. Suitable for transport on an adapter pallet.

Adapter pallet
For picking up, storing and transporting dollies. Dollies can be stored on the adapter pallet. Forklift trucks can pick up the adapter pallet crosswise or lengthwise from all 4 sides.

Pallet Dollies
Standard normed Euro pallet. Suitable for trolley trains, the drawbar on this dolly is completely retractable – this allows forklift trucks to pick up the pallet floor dolly from 3 sides. Optional lashing straps for securing the load are already installed in the frame.

Extensive range of accessories

Taxi wagon
Transport of up to 3 400 x 600 mm dollies at the same time. Self-locking interlock system for additional safety. Low drive-on height – dollies are protected against unintentional rolling out. Suitable for trolley trains.

DOLLIES 400 X 400 MM



Polyamide castors

- The all-roander made from durable plastic
- Suitable for most industrial purposes
- No tilting in monorail stations

Rubber castors

- Recommended for use in tugger trains
- High tracking accuracy
- For low-noise rolling

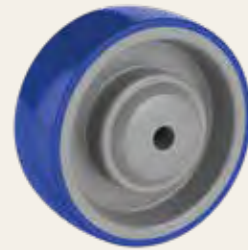

Polyurethane castors

- Convenient transport
- For low-noise rolling
- Harder than rubber rollers

Polyurethane ESD castors

- The all-rounder made from durable plastic
- Suitable for applications in ESD areas
- No tilting in monorail stations



Non-marking polyamide ESD castors

- Made from durable plastic
- Suitable for applications in ESD areas
- Leaves no marks on the floor

ESD rubber castors

- Recommended for use in tugger trains
- High tracking accuracy
- For low-noise rolling

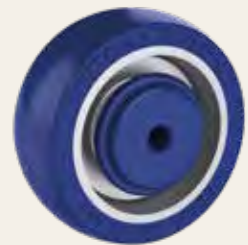

„Clean Wheel“ castors

- For use in cleanrooms
- Do not generate abrasion
- No absorption of dirt



- Dimensions: 179 x 405 x 405 mm (H x W x L)
- Own weight: 6 kg
- Maximum load: 160 kg
- Roller diameter: 100 mm
- Material: Steel
- Stackable
- Castors for different applications
- ESD version available
- Manufactured in accordance with DIN ISO 9001/14001
- With locking corners for smooth container bases
- 2 swivel castors/2 fixed castors

Dollies, 400x400 mm							
	MAT-BORO-3	MAT-BORO-3-PU	MAT-BORO-3-Rubber	MAT-BORO-3-ESD/NM	MAT-BORO-3-ESD/Rubber	MAT-BORO-3-ESD/PU	MAT-BORO-3-CLEAN
Load capacity (kg)	160	160	160	160	160	160	160
Stackable	Yes	Yes	Yes	Yes	Yes	Yes	Yes
Drawbar	No	No	No	No	No	No	No
Locking corners	standard	standard	standard	standard	standard	standard	standard
Range of adapters	Yes	Yes	Yes	Yes	Yes	Yes	Yes
Taxi wagon	No	No	No	No	No	No	No
Roll width/diameter (mm)	35/100	35/100	35/100	35/100	35/100	35/100	35/100
Polyurethane castors	-	standard	-	-	-	-	-
Polyamide castors	standard	-	-	-	-	-	-
Rubber castors	-	-	standard	-	-	-	-
ESD castors	-	-	-	ESD-Non-Marking	ESD-Rubber	ESD-PU	-
Clean Wheel	-	-	-	-	-	-	standard

Price fluctuates greatly.
Please contact us for the current price.

DOLLIES 400 X 600 MM



- Outer dimensions: 600 x 400 x 173 mm (L x W x H)
- Inner dimensions: 580 x 380 x 8 mm (L x W x H)
- Own weight: 6 kg
- Maximum load: 250 kg
- Roller diameter: 100 mm
- Material: Plastic
- Compatible with Euro-size containers
- Stackable
- NOT suitable for transport on an adapter pallet
- 2 swivel castors / 2 fixed castors

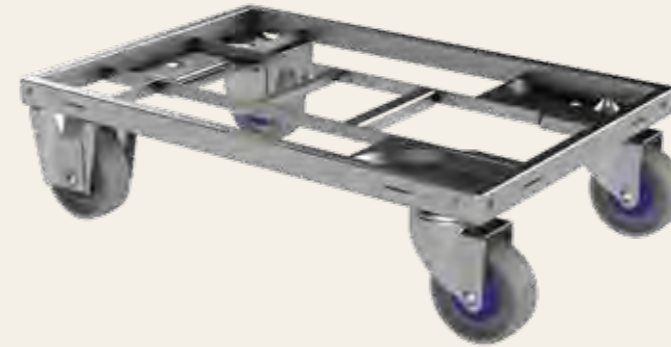

- Dimensions: 162 x 400 x 600 mm (H x W x L)
- Own weight: 6.5 kg
- Maximum load: 250 kg
- Roller diameter: 100 mm
- Material: Steel
- Stackable
- Castors for different applications
- ESD version available
- Manufactured in accordance with DIN ISO 9001/14001
- Suitable for transport on an adapter pallet
- Compatible with Euro-size containers
- Also available with locking corners for smooth container bases
- Extremely true to track
- Suitable for tugger trains (drawbar depending on model)
- 2 swivel castors/2 fixed castors

Dolly, 400 x 600 mm	
	MAT-BORO-KU-2
Load capacity (kg)	250
Stackable	Yes
Drawbar	No
Locking corners	No
Range of adapters	No
Taxi wagon	Yes
Roll width/diameter (mm)	35/100
Polyurethane castors	-
Polyamide castors	standard
Rubber castors	-
ESD castors	-
Clean Wheel	-

Price fluctuates greatly.
Please contact us for the current price.

Dollies, 400 x 600 mm							
	MAT-BORO-1	MAT-BORO-1-PU	MAT-BORO-1-Rubber	MAT-BORO-1-ESD/NM	MAT-BORO-1-ESD/Rubber	MAT-BORO-1-ESD/PU	MAT-BORO-1-CLEAN
Load Capacity (kg)	250	250	250	250	250	250	250
Stackable	Yes	Yes	Yes	Yes	Yes	Yes	Yes
Drawbar	No	No	No	No	No	No	No
Locking corners	Optional	Optional	Optional	Optional	Optional	Optional	Optional
Range of adapters	Yes	Yes	Yes	Yes	Yes	Yes	Yes
Taxi wagon	Yes	Yes	Yes	Yes	Yes	Yes	Yes
Roll width/diameter (mm)	35/100	35/100	35/100	35/100	35/100	35/100	35/100
Polyurethane castors	-	standard	-	-	-	-	-
Polyamide castors	standard	-	-	-	-	-	-
Rubber castors	-	-	standard	-	-	-	-
ESD castors	-	-	-	ESD-Non-Marking	ESD-Rubber	ESD-PU	-
Clean Wheel	-	-	-	-	-	-	standard

Price fluctuates greatly.
Please contact us for the current price.

DOLLIES 400 X 600 MM

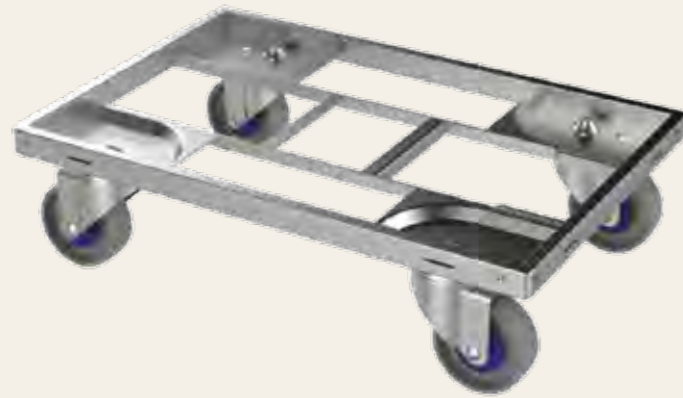

- Dimensions: 162 x 400 x 600 mm (H x W x L)
- Own weight: 7 kg
- Maximum load: 250 kg
- Roller diameter: 100 mm
- Material: Steel
- Stackable
- Castors for different applications
- ESD version available
- Manufactured in accordance with DIN ISO 9001/14001
- Suitable for transport on an adapter pallet
- Compatible with Euro-size containers
- Also available with locking corners for smooth container bases
- 4 swivel castors

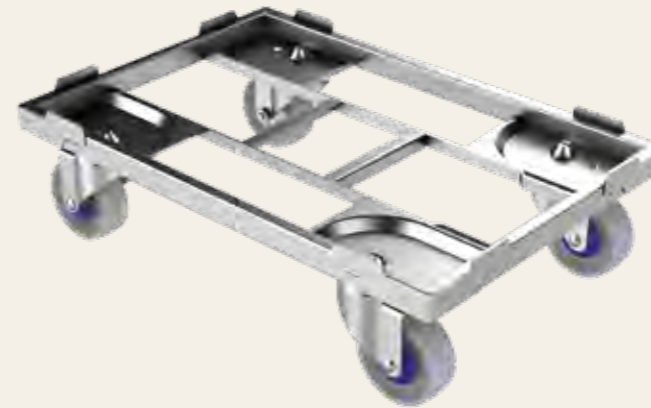

- Dimensions: 157 x 404 x 604 mm (H x W x L)
- Own weight: 7.5 kg
- Maximum load: 250 kg
- Roller diameter: 100 mm
- Material: Steel
- Stackable
- Castors for different applications
- ESD version available
- Manufactured in accordance with DIN ISO 9001/14001
- Suitable for transport on an adapter pallet
- Compatible with Euro-size containers
- With locking corners
- High manoeuvrability
- 4 swivel castors

Dollies 400 x 600 mm

	MAT-BORO-2	MAT-BORO-2-PU	MAT-BORO-2-Rubber	MAT-BORO-2-ESD/NM	MAT-BORO-2-ESD/Rubber	MAT-BORO-2-ESD/PU	MAT-BORO-2-CLEAN
Load capacity (kg)	250	250	250	250	250	250	250
Stackable	Yes	Yes	Yes	Yes	Yes	Yes	Yes
Drawbar	No	No	No	No	No	No	No
Locking corners	Optional	Optional	Optional	Optional	Optional	Optional	Optional
Range of adapters	Yes	Yes	Yes	Yes	Yes	Yes	Yes
Taxi wagon	Yes	Yes	Yes	Yes	Yes	Yes	Yes
Roll width/diameter (mm)	35/100	35/100	35/100	35/100	35/100	35/100	35/100
Polyurethane castors	-	standard	-	-	-	-	-
Polyamide castors	standard	-	-	-	-	-	-
Rubber castors	-	-	standard	-	-	-	-
ESD castors	-	-	-	ESD-Non-Marking	ESD-Rubber	ESD-PU	-
Clean Wheel	-	-	-	-	-	-	standard

Price fluctuates greatly.
Please contact us for the current price.

Dollies, 400 x 600 mm

	MAT-BORO-5-NG	MAT-BORO-5-PU	MAT-BORO-5-Rubber	MAT-BORO-5-ESD/NM	MAT-BORO-5-ESD/Rubber	MAT-BORO-5-ESD/PU	MAT-BORO-5-CLEAN
Load capacity (kg)	250	250	250	250	250	250	250
Stackable	Yes	Yes	Yes	Yes	Yes	Yes	Yes
Drawbar	No	No	No	No	No	No	No
Locking corners	standard	standard	standard	standard	standard	standard	standard
Range of adapters	Yes	Yes	Yes	Yes	Yes	Yes	Yes
Taxi wagon	Yes	Yes	Yes	Yes	Yes	Yes	Yes
Roll width/diameter (mm)	35/100	35/100	35/100	35/100	35/100	35/100	35/100
Polyurethane castors	-	standard	-	-	-	-	-
Polyamide castors	standard	-	-	-	-	-	-
Rubber castors	-	-	standard	-	-	-	-
ESD castors	-	-	-	ESD Non Marking	ESD Rubber	ESD PU	-
Clean Wheel	-	-	-	-	-	-	standard

Price fluctuates greatly.
Please contact us for the current price.

DOLLIES 400 X 600 MM

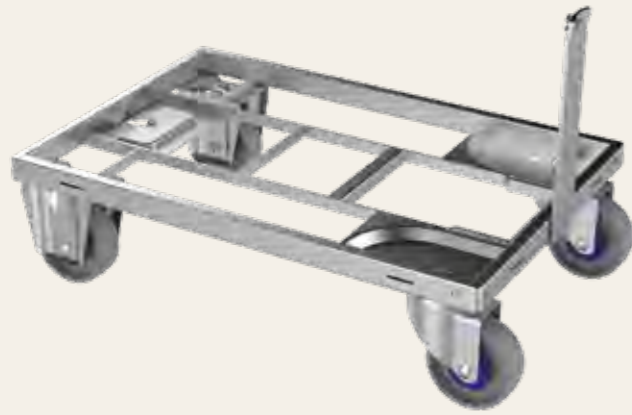

- Dimensions: 162 x 400 x 600 mm (H x W x L)
- Own weight: 7 kg
- Maximum load: 250 kg
- Roller diameter: 100 mm
- Material: Steel
- Stackable
- Castors for different applications
- ESD version available
- Manufactured in accordance with DIN ISO 9001/14001
- Suitable for transport on an adapter pallet
- Compatible with Euro-size containers
- Also available with locking corners for smooth container bases
- Extremely true to track
- Suitable for tugger trains (drawbar depending on model)
- 2 swivel castors/2 fixed castors (swivel castors polyamide, fixed castors rubber)
- With drawbar

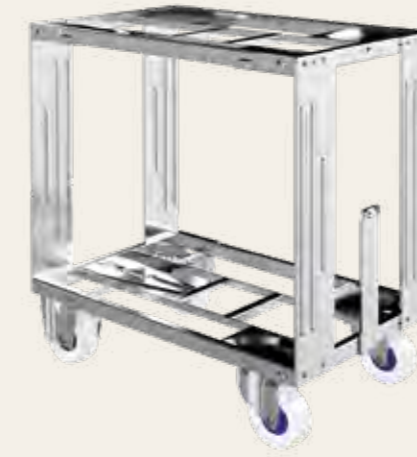

- Dimensions: 612 x 404 x 683 mm (L x W x H)
- Own weight: 18 kg
- Maximum load: 70 kg
- Roller diameter: 100 mm
- Material: Steel
- Castors for different applications
- ESD version available
- Manufactured in accordance with DIN ISO 9001/14001
- Suitable for transport on an adapter pallet
- Compatible with Euro-size containers
- Extremely true to track
- Suitable for tugger trains (drawbar depending on model)
- Ergonomic transport (raised deck)
- 2 swivel castors/2 fixed castors
- With drawbar

Dollies, 400 x 600 mm

	MAT-BORO-7B/ COMBI	MAT-BORO-7B- Rubber	MAT-BORO-7B- ESD/COMBI	MAT-BORO-7B- ESD/NM	MAT-BORO-7B- ESD/Rubber	MAT-BORO-7B- CLEAN
Load capacity (kg)	250	250	250	250	250	250
Stackable	Yes	Yes	Yes	Yes	Yes	Yes
Drawbar	standard	standard	standard	standard	standard	standard
Locking corners	Optional	Optional	Optional	Optional	Optional	Optional
Range of adapters	Yes	Yes	Yes	Yes	Yes	Yes
Taxi wagon	Yes	Yes	Yes	Yes	Yes	Yes
Roll width/diameter (mm)	35/100	35/100	35/100	35/100	35/100	35/100
Polyurethane castors	-	-	-	-	-	-
Polyamide castors	standard	-	ESD-PA	ESD-Non-Marking	-	-
Rubber castors	standard	standard	standard	standard	ESD-Rubber	-
Clean Wheel	-	-	-	-	-	standard

Price fluctuates greatly.
Please contact us for the current price.

Dollies, 400 x 600 mm

	MAT-BORO-7C	MAT-BORO-7C- Rubber	MAT-BORO-7C- ESD/COMBI	MAT-BORO-7C- ESD/NM	MAT-BORO-7C- ESD/Rubber	MAT-BORO-7C- CLEAN
Load capacity (kg)	70	70	70	70	70	70
Stackable	No	No	No	No	No	No
Drawbar	standard	standard	standard	standard	standard	standard
Locking corners	No	No	No	No	No	No
Range of adapters	Yes	Yes	Yes	Yes	Yes	Yes
Taxi wagon	Yes	Yes	Yes	Yes	Yes	Yes
Roll width/diameter (mm)	35/100	35/100	35/100	35/100	35/100	35/100
Polyurethane castors	-	-	-	-	-	-
Polyamide castors	standard	-	ESD-PA	ESD-Non-Marking	-	-
Rubber castors	standard	standard	standard	standard	ESD-Rubber	-
Clean Wheel	-	-	-	-	-	standard

Price fluctuates greatly.
Please contact us for the current price.

DOLLIES 800 X 600 MM

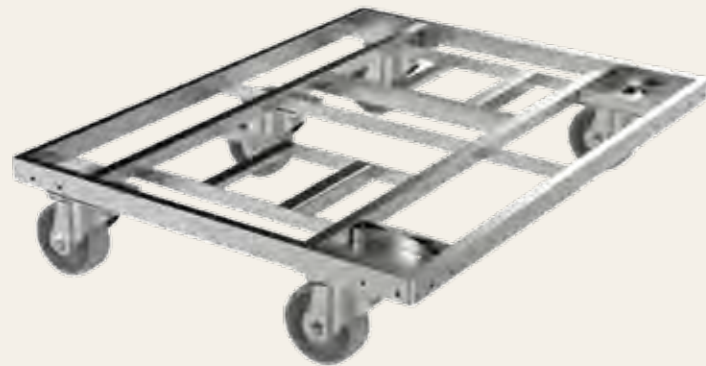

- Dimensions: 158 x 800 x 600 mm (H x W x L)
- Own weight: 12 kg
- Maximum load: 500 kg
- Roller diameter: 100 mm
- Material: Steel
- Stackable
- Castors for different applications
- ESD version available
- Manufactured in accordance with DIN ISO 9001/14001
- Suitable for transport on an adapter pallet
- Compatible with Euro-size containers
- Also available with locking corners for smooth container bases
- Suitable for tugger trains (drawbar depending on model)
- High manoeuvrability
- 5 swivel castors

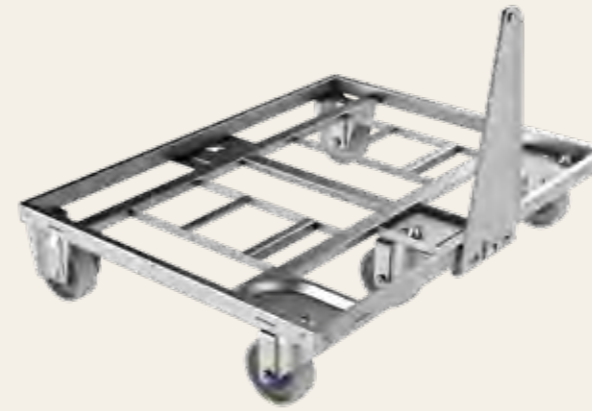

- Dimensions: 495 x 800 x 600 mm (H x W x L)
- Own weight: 12 kg
- Maximum load: 500 kg
- Roller diameter: 100 mm
- Material: Steel
- Stackable
- Castors for different applications
- ESD version available
- Manufactured in accordance with DIN ISO 9001/14001
- Suitable for transport on an adapter pallet
- Compatible with Euro-size containers
- Also available with locking corners for smooth container bases
- Extremely true to track
- Suitable for tugger trains (drawbar depending on model)
- Ergonomic transport
- 3 swivel castors/2 fixed castors
- With drawbar

Dollies, 800 x 600 mm

	MAT-BORO-800-5L	MAT-BORO-800-5L-Rubber	MAT-BORO-800-5L-ESD/NM	MAT-BORO-800-5L-ESD/Rubber	MAT-BORO-800-5L-CLEAN
Load capacity (kg)	500	500	500	500	500
Stackable	Yes	Yes	Yes	Yes	Yes
Drawbar	No	No	No	No	No
Locking corners	Optional	Optional	Optional	Optional	Optional
Range of adapters	Yes	Yes	Yes	Yes	Yes
Taxi wagon	Yes	Yes	Yes	Yes	Yes
Roll width/diameter (mm)	35/100	35/100	35/100	35/100	35/100
Polyurethane castors	-	-	-	-	-
Polyamide castors	standard	-	-	-	-
Rubber castors	-	standard	-	-	-
ESD castors	-	-	ESD-Non-Marking	ESD-Rubber	-
Clean Wheel	-	-	-	-	standard

Price fluctuates greatly.
Please contact us for the current price.

Dollies, 800 x 600 mm

	MAT-BORO-800D-2-COMBI	MAT-BORO-800D-2-PU	MAT-BORO-800D-2-Rubber	MAT-BORO-800D-2-ESD/NM	MAT-BORO-800D-2-ESD/Rubber	MAT-BORO-800D-2-ESD-COMBI	MAT-BORO-800D-2-CLEAN
Load capacity (kg)	500	500	500	500	500	500	500
Stackable	Yes	Yes	Yes	Yes	Yes	Yes	Yes
Drawbar	standard	standard	standard	standard	standard	standard	standard
Locking corners	Optional	Optional	Optional	Optional	Optional	Optional	Optional
Range of adapters	Yes	Yes	Yes	Yes	Yes	Yes	Yes
Taxi wagon	Yes	Yes	Yes	Yes	Yes	Yes	Yes
Roll width/diameter (mm)	35/100	35/100	35/100	35/100	35/100	35/100	35/100
Polyurethane castors	-	standard	-	-	-	-	-
Polyamide castors	standard	-	-	ESD-Non-Marking	-	ESD-PA	-
Rubber castors	standard	standard	standard	ESD-Rubber	ESD-Rubber	ESD-Rubber	-
Clean Wheel	-	-	-	-	-	-	standard

Price fluctuates greatly.
Please contact us for the current price.

DOLLIES 800 X 1200 MM



- Dimensions: 318 x 840 x 1240 mm (H x W x L)
- Own weight: 29 kg
- Maximum load: 1000 kg
- Roller diameter: 200 mm
- External dimensions: 1240 x 840 x 318 mm
- Material: Steel
- Stackable
- Manufactured in accordance with DIN ISO 9001/14001
- Also available with locking corners for smooth container bases
- 4 swivel castors (optionally with 2 swivel castors/2 fixed castors)

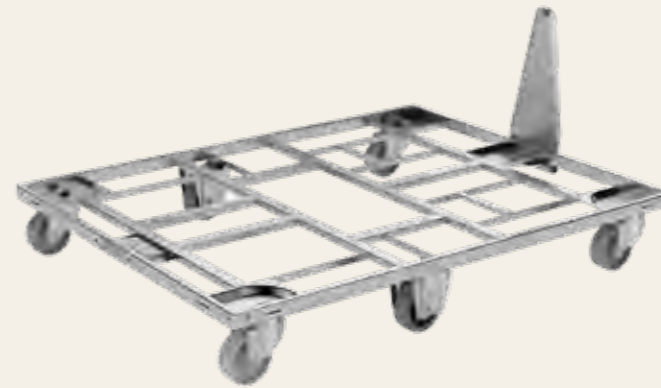

- Dimensions: 502 x 800 x 1212 mm (H x W x L)
- Own weight: 19 kg
- Maximum load: 300 kg
- Roller diameter: 100 mm
- Material: Steel
- Stackable
- Castors for different applications
- ESD version available
- Manufactured in accordance with DIN ISO 9001/14001
- Suitable for transport on an adapter pallet
- Also available with locking corners for smooth container bases
- 4 swivel castors/2 fixed castors

Dolly, 800 x 1200 mm	
	MAT-BORO-1200x800-DC
Load capacity (kg)	1000
Stackable	Yes
Drawbar	No
Locking corners	standard
Range of adapters	No
Taxi wagon	No
Roll width/diameter (mm)	40/200
Polyurethane castors	-
Polyamide castors	standard
Rubber castors	-
ESD castors	-
Clean Wheel	-

Price fluctuates greatly.
Please contact us for the current price.

Dollies, 800 x 1200 mm							
	MAT-BORO-1200x800-A	MAT-BORO-1200x800-A-PU	MAT-BORO-1200x800-A-Rubber	MAT-BORO-1200x800-A-ESD/NM	MAT-BORO-1200x800-A-ESD/Rubber	MAT-BORO-1200x800-A-ESD/PU	MAT-BORO-1200x800-A-CLEAN
Load capacity (kg)	300	300	300	300	300	300	300
Stackable	Yes	Yes	Yes	Yes	Yes	Yes	Yes
Drawbar	standard	standard	standard	standard	standard	standard	standard
Locking corners	Optional	Optional	Optional	Optional	Optional	Optional	Optional
Range of adapters	Yes	Yes	Yes	Yes	Yes	Yes	Yes
Taxi wagon	No	No	No	No	No	No	No
Roll width/diameter (mm)	35/100	35/100	35/100	35/100	35/100	35/100	35/100
Polyurethane castors	-	standard	-	-	-	ESD PU	-
Polyamide castors	standard	-	-	ESD-Non-Marking	-	-	-
Rubber castors	standard	standard	standard	ESD-Rubber	ESD-Rubber	ESD-Rubber	-
Clean Wheel	-	-	-	-	-	-	standard

Price fluctuates greatly.
Please contact us for the current price.

PALLET DOLLY 600 X 800 MM



- Polyurethane castors: 160 mm
- Swivel castors with brakes
- Load capacity: maximum 1000 kg
- Lashing system: 1 strap (optional)
- Surface galvanised
- Loading from 3 sides possible due to retractable drawbar
- Suitable for tugger trains (drawbar depending on model)



Pallet-Dolly, 600x800 mm

Order no.	Swivel-/fixed castors	Version	Width (mm)	Length (mm)
MAT-BORO-800x600	2/2 (polyurethane)	Wooden deck	600	800
MAT-BORO-800x600-1	2/2 (polyurethane)	Open	600	800
MAT-BORO-800x600V	2/2 (polyurethane)	Wooden deck (lashing system: 1 belt)	600	800
MAT-BORO-800x600V1	2/2 (polyurethane)	Open (lashing system: 1 belt)	600	800

Price fluctuates greatly.
Please contact us for the current price.

PALLET-DOLLY 800 X 1200 MM



- Polyurethane castors: 160 mm
- Swivel castors with brakes
- Load capacity: maximum 1000 kg
- Lashing system: 2 straps (optional)
- Surface galvanised
- Loading from 3 sides possible due to retractable drawbar
- Suitable for tugger trains (drawbar depending on model)



Pallet Dolly, 800x1200 mm

Order no.	Swivel-/fixed castors	Version	Width (mm)	Length (mm)
MAT-BORO-1200x800	2/2 (polyurethane)	Wooden deck	800	1200
MAT-BORO-1200x800-1	2/2 (polyurethane)	Open	800	1200
MAT-BORO-1200x800V	2/2 (polyurethane)	Wooden deck (lashing system: 2 belts)	800	1200
MAT-BORO-1200x800V1	2/2 (polyurethane)	Open (lashing system: 2 belts)	800	1200

Price fluctuates greatly.
Please contact us for the current price.

ACCESSORIES



Produced by:
K.HARTWALL
Logistics Efficiency through Innovation

Push bar for dollies

Order no.

MAT-STANGE

The ergonomically designed push bar is the ideal aid, especially for dollies with a low loading height. It is easy to attach and can be used immediately as a pushing or pulling aid. Can be used for all K.Hartwall Dolly types.



Oil pan for dolly, galvanised, anodised

Order no.

Version

MAT-BORO-ZB001 for dolly, 400 x 600 mm

MAT-BORO-ZB002 for dolly, 800 x 600 mm

Drip-tight and impact-resistant oil pan made of anodised steel.



Produced by:
K.HARTWALL
Logistics Efficiency through Innovation

Oil pan for dolly, plastic

Order no.

Version

MAT-BORO-ZB004 for dolly, 400 x 600 mm

Drip-tight oil pan made of deep-drawn plastic.



Produced by:
K.HARTWALL
Logistics Efficiency through Innovation

Wooden lid for dolly

Order no.

Version

MAT-BORO-ZB003 for dolly, 800 x 600 mm

Wooden top deck for transporting non-form-fit containers.

Price fluctuates greatly.
Please contact us for the current price.



Produced by:
K.HARTWALL
Logistics Efficiency through Innovation

Drawbar for taxi wagons

Order no.

MAT-SD

- Depending on tractor type
- Maximum towing weight: 6 tonnes (drawbar), 2 tonnes (pivot)
- Sturdy, welded steel construction
- Development under consideration of ergonomic aspects
- Quick and easy foot operation
- High-quality design with gas pressure cylinder
- Suitable for the most common tractor types
- Compatible with all dolly types, shelf wagon and the MAT-TAXI002 taxi wagon model



SHELF WAGON 800 X 1200 MM



- Total load capacity: 450 kg
- Levels adjustable at a distance of 50 mm
- Load volume: 4 x KLT 400 x 600 mm per level
- 2 swivel and 2 fixed castors
- 160 mm polyurethane castors
- Standard equipment: 3 shelves and base plate
- With cover, route train capable
- Internal dimensions (L x W x H): 1200 x 800 x 1367 mm
- External dimensions (L x W x H): 1260 x 808 x 1675 mm



- Dimensions: 1810 x 820 x 1220 mm (H x W x L)
- Own weight: 65 kg
- Maximum load: 1000 kg
- Roller diameter: 200 mm
- Material: hard-wearing plastic
- 4 levels
- Levels at a distance of 365 mm
- 2 swivel castors/2 fixed castors with rear brake



Shelf wagon, 800x1200 mm

Order no.	Swivel-/fixed castors	Designation	Width (mm)	Length (mm)
MAT-RW12X8-001	2/2 (polyurethane)	Shelf wagon	808	1260
MAT-RW-ZB001	-	Cover for shelf wagon	-	-

Price fluctuates greatly.
Please contact us for the current price.

Produced by:
 

Shelf wagon, 800x1200 mm

Order no.	Swivel-/fixed castors	Designation	Width (mm)	Length (mm)
MAT-BORO-1200x800-EB	2/2 (Polyamid)	Shelf wagon	820	1220

Price fluctuates greatly.
Please contact us for the current price.

Produced by:
 

TAXI WAGON FOR DOLLIES



- Transport of dollies over long distances
- Loading and unloading on both sides
- Maximum load: 750 kg
- Extremely low loading height
- Operation of the drive-on ramps by hand lever (interlock system)



Taxi wagon for dollies

Order no.	Swivel-/fixed castors	Version	Width (mm)	Length (mm)
MAT-TAXI001	4/- (polyurethane)	for 3 Dollies, 400 mm	726	2480
MAT-TAXI002	2/2 (polyurethane)	for 3 Dollies, 400 mm	726	2287
MAT-TAXI003	4/- (polyurethane)	for 4 Dollies, 400 mm	726	3161

Price fluctuates greatly.
Please contact us for the current price.



ADAPTER PALLET FOR DOLLIES

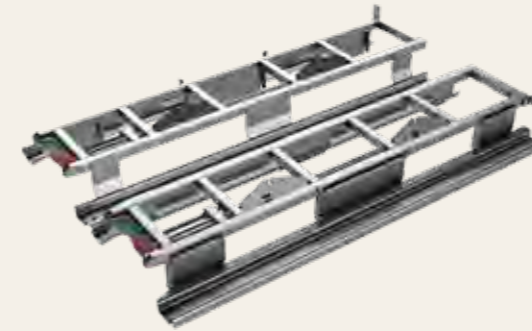

Adapter range for:

- 6 Dollies each 400 x 400 mm
- 4 Dollies each 400 x 600 mm
- 2 Dollies each 800 x 600 mm
- 2 Dollies à 400 x 600 mm
- 1 Dolly à 800 x 600 mm

- Material: Steel
- Own weight: 39 kg
- Load capacity: 1000 kg
- Galvanised
- Suitable for lorry transport
- Storage in heavy-duty racking possible
- Stackable loaded and unloaded
- Increased stability
- Low weight
- Savings on transport costs



Adapter pallet for Dollies

Order no.	Width (mm)	Length (mm)
MAT-ADAP-5	800	1200

Price fluctuates greatly.
Please contact us for the current price.



Produced by:

K.HARTWALL
Logistics Efficiency through Innovation



LIDS WITH INTEGRATED BELT SYSTEM



- Material: Polypropylene
- Own weight: 8 kg
- Version with 6 handles
- For internal transport only
- Maximum load capacity: 2000 kg
- With integrated belt system suitable for plastic, wooden and adapter pallets
- Also available as an ESD version



LID, LASHING STRAP

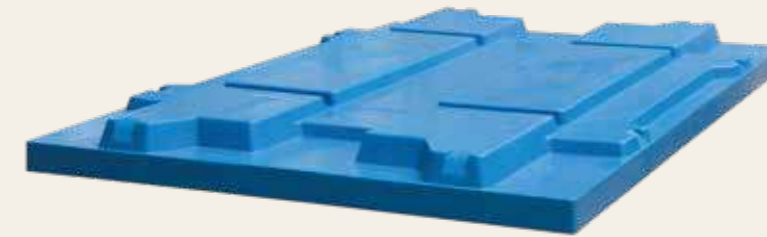

- Material: Polypropylene
- Own weight: 1 kg
- Version with 4 strapping grooves
- For internal transport only
- Maximum load capacity: 1000 kg



Lids with integrated belt system

Order no.	Designation	Version
MAT-PD1	Pallet lid with integrated belt	for plastic and wooden pallets
MAT-PD1-ESD	ESD pallet support lid with integrated strap	for plastic and wooden pallets
MAT-PD2	Pallet support lid with integrated belt	for adapter pallets
MAT-PD2-ESD	ESD pallet support lid with integrated strap	for adapter pallets

Price fluctuates greatly.
Please contact us for the current price.

Lid, Lashing strap

Order no.	Designation
MAT-ADAP-ZB002	Pallet support lid
MAT-ADAP-ZB001	Lashing strap

Price fluctuates greatly.
Please contact us for the current price.



MATERIAL SUPPLY

Given the wide range of variants in today's productions, a reliable supply of materials is essential. Modern production companies rely on station systems, also known as supermarkets. These systems are based on the „first in – first out“ principle, FiFo for short, which prevents damage caused by excessive storage and ensures easy traceability in the event of material errors or malfunctions.



[katalog.orgatex.com/
materialbereitstellung](https://katalog.orgatex.com/materialbereitstellung)

FiFo-Monorail	From 276
FiFo-Monorail, 40 mm – 5S	276
FiFo-Monorail, 55 mm – 5S	277
FiFo-Monorail, individual	278
eOX-Monomover	279
eOX-Station	280
FiFo-Monorail Signage 5S	282
Accessories FiFo-Monorail	From 283
Accessories FiFo-Monorail, 40 mm	283
Accessories FiFo-Monorail, 55 mm	284
Accessories FiFo-Monorail, 40 mm and 55 mm	286
FiFo-station system for all roll widths	From 287
FiFo-station system	288
Flatrail for commission areas	290
Parking slot, aluminium	291
Parking slot, aluminium, combination options	292
Parking slot, plastic	294
Crate lifter KLT-Lifter	296
Workstation systems	From 298
Workstation systems, static	300
Workstation systems, height-adjustable	301

Station systems work in a similar way to a flow rack: because fill levels are immediately visible, the goods can be replenished and made available with pinpoint accuracy and the required quantity can be pre-picked. The individual lanes of the station are labelled and ensure that different products are clearly separated, eliminating the risk of mix-ups when picking. The system therefore ensures an optimised material flow with increased efficiency, reduced stock levels and minimised space requirements. ORGATEX® offers you both monorail rail systems with a wide range of options for your individual material supply requirements.

We offer parking bays with the highest possible flexibility as well as systems for permanent installation, each suitable for different roller widths. In addition, our portfolio includes aluminium or plastic parking bays that prevent dollies from rolling away: this allows products to be positioned precisely and, for example, made available at the workplace in a space-saving manner.

Rely on precise rolling material supply as part of modern logistics in your company – we have the right solutions for you.



INFOGRAPHIC MATERIAL SUPPLY

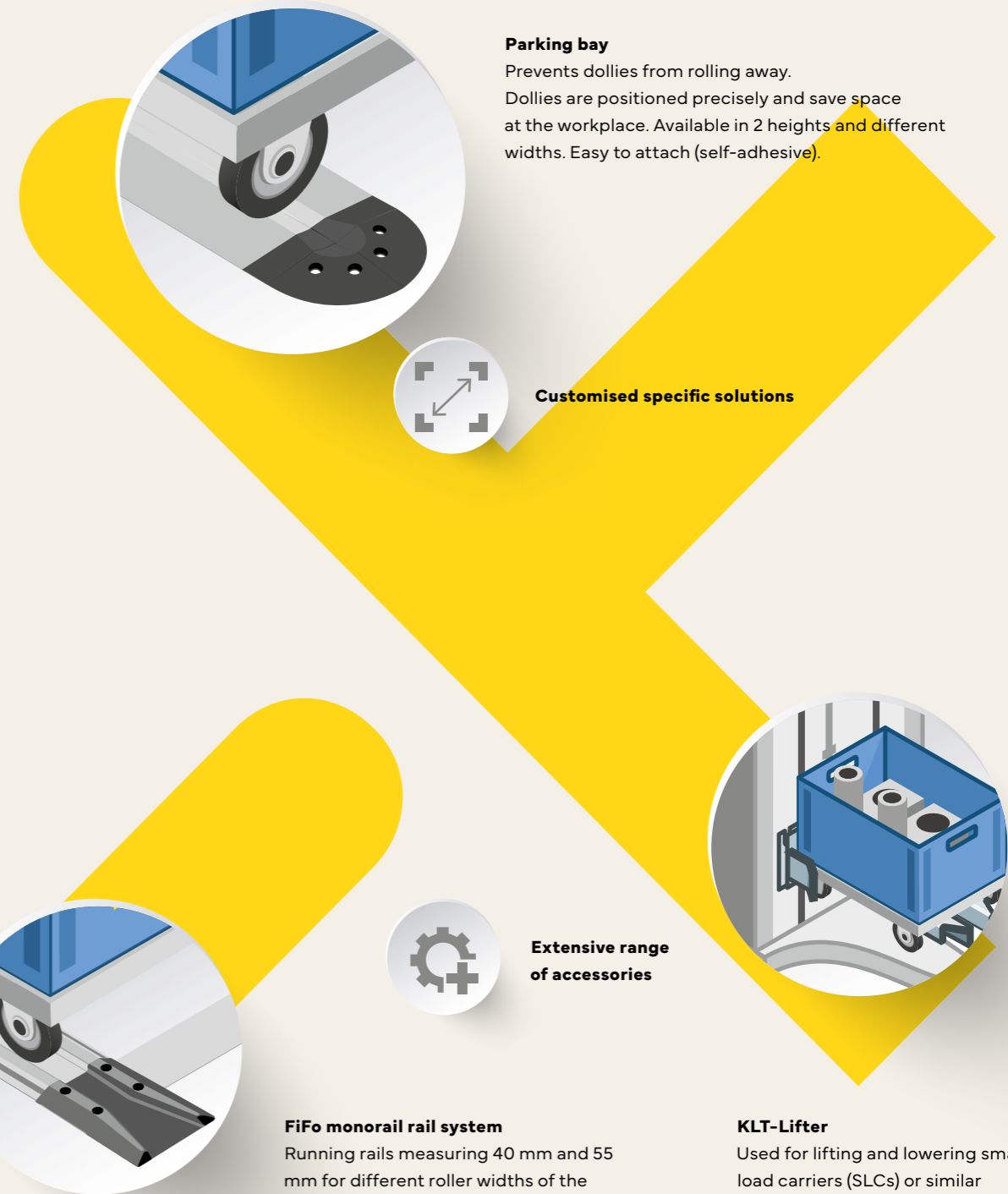
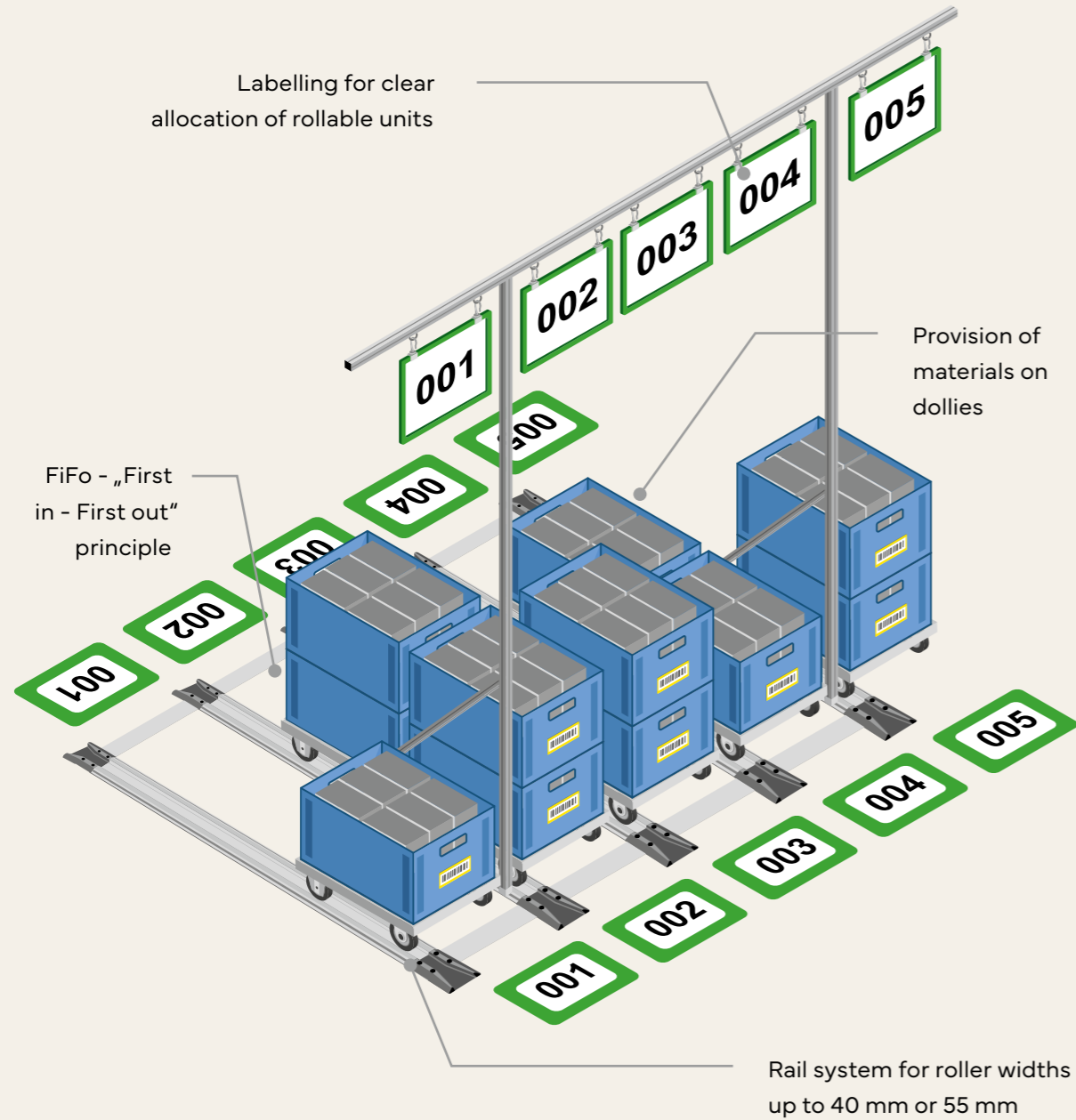

Parking bay
Prevents dollies from rolling away. Dollies are positioned precisely and save space at the workplace. Available in 2 heights and different widths. Easy to attach (self-adhesive).

Customised specific solutions

Extensive range of accessories

FiFo monorail rail system
Running rails measuring 40 mm and 55 mm for different roller widths of the dollies. Flexible lengths and widths mean that the system can be extended as required, even after installation. The standardised labelling of station systems ensures clear allocation of rollable units.

KLT-Lifter
Used for lifting and lowering small load carriers (SLCs) or similar containers to an ergonomic working height.



For different roll widths



Ergonomic workplace



For tidiness and cleanliness



FIFO-MONORAIL 40 MM – 5S

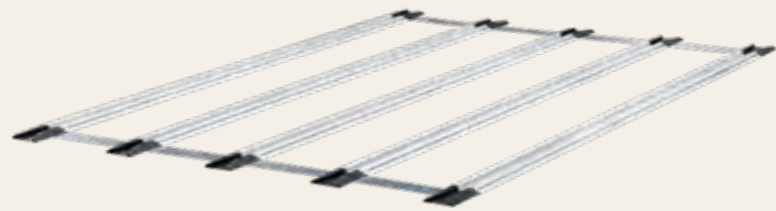

- Consists of:
- 5 FiFo monorail tracks
 - 10 FiFo monorail end caps
 - 20 grub screws
 - 8 FiFo monorail connecting plates
 - 32 Sleeve nuts

- Rail system for roll widths up to 40 mm.
- Clear allocation of the material
 - Easy insertion of the dollies
 - Quick assembly
 - Extendable in length and width



FiFo-Monorail, 40 mm – 5S		
Order no.	Version	Track width (mm)
MONO-5S-1200	FiFo-Monorail-station, 1200 mm	400
MONO-5S-1800	FiFo-Monorail-station, 1800 mm	400
MONO-5S-2400	FiFo-Monorail-station, 2400 mm	400
MONO-5SVB8-1200	FiFo-Monorail-station, 1200 mm	800
MONO-5SVB8-1800	FiFo-Monorail-station, 1800 mm	800
MONO-5SVB8-2400	FiFo-Monorail-station, 2400 mm	800

Price fluctuates greatly.
Please contact us for the current price.



FIFO-MONORAIL 55 MM – 5S



- Consists of:
- 5 FiFo monorail tracks
 - 10 FiFo monorail end caps
 - 20 grub screws
 - 8 FiFo monorail connecting plates
 - 32 Sleeve nuts

- Rail system for roll widths up to 55 mm.
- Clear allocation of the material
 - Easy insertion of the dollies
 - Quick assembly
 - Extendable in length and width



FiFo-Monorail, 55 mm – 5S		
Order no.	Version	Track width (mm)
MONO-5S-1200-55	FiFo-Monorail-pcs.tion , 1200 mm	400
MONO-5S-1800-55	FiFo-Monorail-pcs.tion , 1800 mm	400
MONO-5S-2400-55	FiFo-Monorail-pcs.tion , 2400 mm	400
MONO-5SVB8-1200-55	FiFo-Monorail-pcs.tion , 1200 mm	800
MONO-5SVB8-1800-55	FiFo-Monorail-pcs.tion , 1800 mm	800
MONO-5SVB8-2400-55	FiFo-Monorail-pcs.tion , 2400 mm	800

Price fluctuates greatly.
Please contact us for the current price.



FIFO-MONORAIL INDIVIDUAL



Rail system for customised roller widths. The dollies can be guided on one or both sides at the outer edges. Must be installed in the floor.

- Clear allocation of the material
- Easy insertion of the dollies
- Quick assembly
- Extendable in length and width



FiFo-Monorail, individual

Order no.	Designation	Version	Consisting of	Pack
MONO-SP-1200-V	Monorail flank	1200 mm	2 flanks, 4 fixing brackets, incl. fixing material	2 flanks
MONO-SP-1800-V	Monorail flank	1800 mm	2 flanks, 4 fixing brackets, incl. fixing material	2 flanks
MONO-SP-2400-V	Monorail flank	2400 mm	2 flanks, 6 fixing brackets, incl. fixing material	2 flanks
MONO-SP-EK-V	End cap set	-	2 left and 2 right end caps, incl. fixing material	2 left, 2 right
MONO-HB-SET	Mounting bracket	-	2 mounting brackets, incl. mounting material	2 pieces

Price fluctuates greatly.
Please contact us for the current price.



EOX-MONOMOVER



More efficiency for your FiFo station:

Recognise goods removal and allow replenishment to advance

The modular design of the feed unit allows any number of dollies to be conveyed simultaneously. This allows the system to grow dynamically with your requirements. The integrated bristle belts transport individual dollies independently from A to B. The length of the track is unlimited and is also compatible with existing IoT ecosystems. Thanks to its compact design, the eOX-Monomover also ensures an automatic and seamless flow of goods. Rely on a secure system with an intelligent core – and save time and money!

- Light barriers at the module ends
- Bristle belt from synthetic leather
- Lift can be integrated
- Unlimited track length



eOX-Monomover

Order no.	Designation
EOX-MONOMOVER	Feed unit for dolly

Price fluctuates greatly.
Please contact us for the current price.



EOX-STATION



How to configure your FiFo tracks digitally

A FiFo railway station with a digital extension – that is the eOX station! Digitally link up to 120 tracks to a central calculation unit that is connected directly to the station. You can configure the individual tracks as required via the so-called eOX gateway and assign different track groups, for example. Sensors directly on the tracks then automatically recognise when dollies are pushed into a track or pulled out of a track. Practical: The sensor technology corresponds to the signalling lights above the station. Red or green? The colour tells your employees which

status the lane is currently in! This means you always know whether dollies can already be removed or should remain in the station.

- Classic FiFo station, digitally enhanced
- Up to 120 tracks can be linked together
- Sensors register dollies when retracting and extending
- High level of safety: system operates with 24 V DC (direct current)

eOX-Station

Order no.	Designation
EOX-STATION	Digital railway station





FIFO-MONORAIL LABELLING 5S

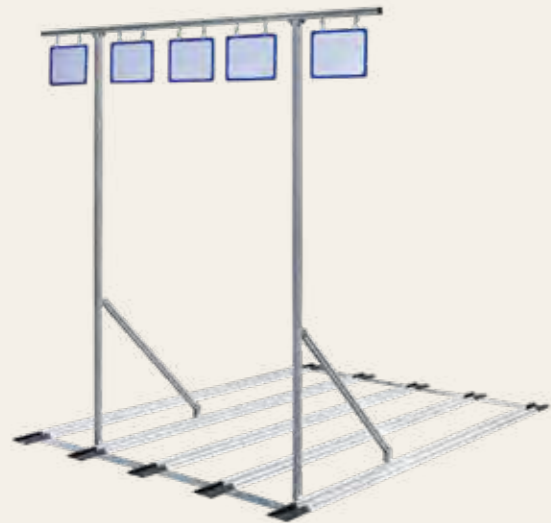

Standardised labelling for station systems ensures clear allocation of rollable units. Incorrect loading can be ruled out and loading and unloading is significantly simplified.



FiFo-Monorail, Labelling 5S

Order no.	+ colour code	Designation	Pack
MONO-SB5S	—	Labelling, track width 400 mm incl. fastening material	1 piece
MONO-SB5SVB8	—	Labelling, track width 800 mm incl. fastening material	1 piece
PKR-A4-100-	01 02 03 04 05 06 08 88	Hanging sign, DIN A4 (optionally available)	5 pieces

Price fluctuates greatly.
Please contact us for the current price.



ACCESSORIES FIFO-MONORAIL 40 MM



FiFo-Monorail end caps, 40 mm

Order no.	Pack
MONO-EK	10 pcs.

The V-shaped base element allows easy loading and unloading of dollies.
The integrated mounting plates enable connection to the 40 mm monorail track system.



FiFo-Monorail end caps HD, 40 mm

Order no.
MONO-EK-HD-40

The V-shaped, **extremely robust** base element allows easy loading and unloading of dollies.
The integrated mounting plates enable connection to the 40 mm monorail track system.

Incl. mounting material.



FiFo-Monorail end caps, 40 mm splayed

Order no.
MONO-EKGS-V2

The splayed retraction element is used on the loading side and makes it easier to fill the monorail station, especially with large/convoluted load carriers. With integrated collision protection, suitable for a roll width of up to 40 mm.

Incl. 2 screw connectors with 8 grub screws.



FiFo-Monorail tracks, 40 mm

Order no.	Version	Pack
MONO-BP-1200	40 x 1200 mm	5 pcs.
MONO-BP-1800	40 x 1800 mm	5 pcs.
MONO-BP-2400	40 x 2400 mm	5 pcs.

Rail system for single-sided guidance of dollies with a roller width of up to 40 mm. The 8 mm grooves on both sides are used for additional mounting of signage and enable integration into existing workstation systems, for example. Aluminium profile with anodised surface.

Price fluctuates greatly.
Please contact us for the current price.



ACCESSORIES FIFO-MONORAIL 55 MM



FiFo-Monorail end caps, 55 mm

Order no.	Pack
MONO-BP-55-EK	10 pcs.

The V-shaped base element allows easy loading and unloading of dollies. The integrated mounting plates enable connection to the 55 mm monorail rail system.



FiFo-Monorail end caps HD, 55 mm

Order no.	Pack
MONO-EK-HD-55	

The V-shaped, extremely robust base element allows easy loading and unloading of dollies. The integrated mounting plates enable connection to the 55 mm monorail track system.

Incl. mounting material.



FiFo-Monorail end caps, 55 mm, splayed

Order no.	Pack
MONO-BP-55-EKGS-V2	

The spread infeed element is used on the loading side and makes it easier to fill the monorail station, especially with large/cluttered load carriers. With integrated collision protection, suitable for a roll width of up to 55 mm.

Incl. 2 screw connectors with 8 grub screws.



FiFo-Monorail rails, 55 mm

Order no.	Version	Pack
MONO-BP-55-1200	55 x 1200 mm	5 pcs.
MONO-BP-55-1800	55 x 1800 mm	5 pcs.
MONO-BP-55-2400	55 x 2400 mm	5 pcs.

Rail system for single-sided guidance of dollies with a roller width of up to 55 mm. The 8 mm grooves on both sides are used for additional mounting of signage and enable integration into existing workstation systems, for example. Aluminium profile with anodised surface.

Price fluctuates greatly.
Please contact us for the current price.



FiFo-Monorail collision protection

Order no.	Pack
MONO-EK-AS	1 set

A solid steel bracket protects the end cap from impact. Complete set incl. fixing material. 1 set = collision protection left and right, incl. 2 hammer nuts and 2 half-round bolts.



FiFo-Monorail angle

Order no.	Pack
MONO-HB	2 pcs.

Mounting bracket for stabilising/screwing long monorail tracks.

Complete set incl. fixing anchor.



FiFo-Monorail connecting element

Order no.	Pack
MONO-SV-100	10 pcs.

Screw connector for easy extension of monorail tracks in the 8 mm groove system. Incl. 40 grub screws.



FiFo-Monorail slot cover, 2000 mm

Order no.	+ colour code	Pack
MONO-NA-2000-	04 06 88	10 pcs.

Groove covers prevent soiling of the side grooves. Precisely fitting, easy to retrofit, available in 3 colours and suitable for cleanrooms.

Length: 2000 mm.

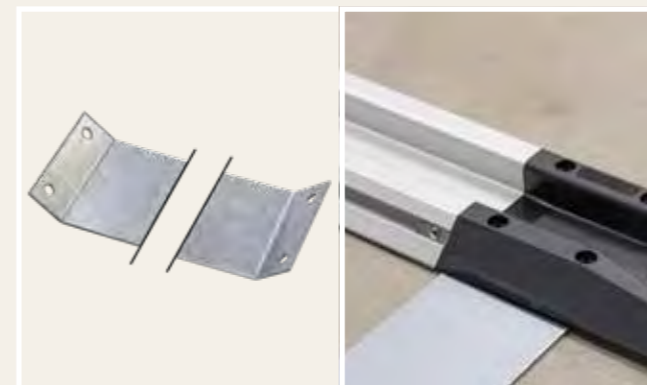

FiFo-Monorail 40 mm connecting plates

Order no.	Version	Pack
MONO-VB-2	400-mm-plate for 40-mm-track	2 pcs.
MONO-VB-800	800-mm plate for 40-mm-track	2 pcs.

Connecting plate for coupling individual monorail tracks next to each other. Assembly takes place in the end cap. The modular system means that it does not need to be screwed into the floor. Suitable for monorail, 40 mm. Complete set incl. mounting material.

Price fluctuates greatly.
Please contact us for the current price.



ACCESSORIES FIFO-MONORAIL 40 MM AND 55 MM

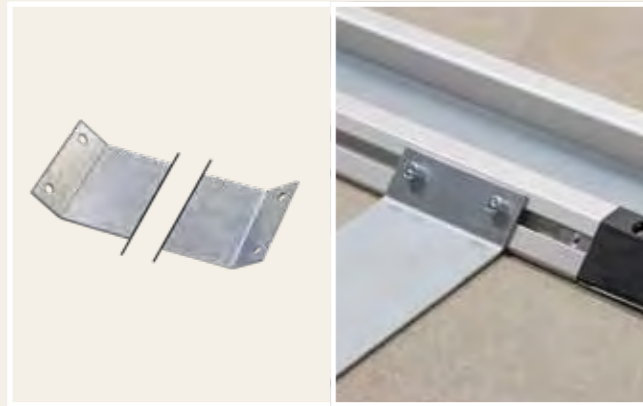

FiFo-Monorail-55 mm-connecting plates

Order no.	Version	Pack
MONO-VB-W45D	400-mm-sheet for 55-mm-track	2 pcs.
MONO-VB-800-W45D	800-mm-sheet for 55-mm-track	2 pcs.

The angled connecting plate on both sides enables the installation of tracks of different lengths. Installation takes place in the monorail track. Suitable for monorail, 40 mm and 55 mm.

Complete set incl. mounting material.



FiFo-Monorail brake

Order no.
MONO-BBR-200

The brush brake prevents dollies from rolling out automatically, e.g. into driveways/walkways or production areas.

Complete set incl. mounting material.

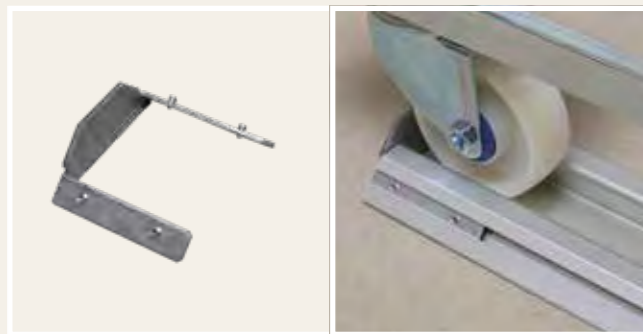

LiFo-Monorail stop

Order no.	Version
MONO-STOP	40 mm
MONO-STOP-55	55 mm

The monorail stop prevents the dollies from rolling out. Is generally used with the LiFo principle (last in - first out).

Incl. 4 grub screws.



Monorail-Backstop

Order no.
MONO-RLS

The monorail backstop ensures that the dollies can no longer run back off the rails.

Incl. 2 half-round bolts M6x12, 2 hammer nuts M6.

Price fluctuates greatly.
Please contact us for the current price.



FIFO-STATION SYSTEM FOR ALL CASTOR WIDTHS



Due to its flexibility, the system can be used for almost all roller-guided material carriers.

- Suitable for all roller diameters and track widths
- Simple assembly
- Rail colour with signal effect

By integrating an aluminium profile into the guide rail, individual applications can be created, e.g. enclosures or information provision, can be easily realised. The height of the permitted number of containers on the staging lanes can be restricted by installing gates.

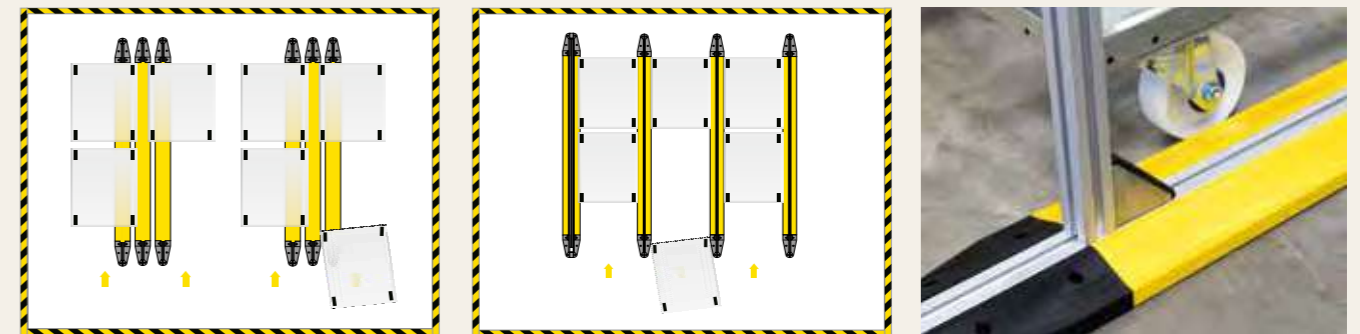



FIFO-STATION SYSTEM



End cap, left and right, self-adhesive

Order no.	Version	Length (mm)	Pack
FIFO-EK-2L	End cap, left	225	1 pc.
FIFO-EK-2R	End cap, right	225	1 pc.
FIFO-SCHR-K	Screw set for caps and connectors		20 pcs.

- Drive-in aid for dollies
- With 3 holes for mounting
- Self-adhesive



End cap, double, self-adhesive

Order no.	Execution	Length x width (mm)	Pack
FIFO-EK-1	End cap, double	225 x 130	1 pc.
FIFO-SCHR-K	Screw set for caps and connectors		20 pcs.

- Drive-in aid for dollies for the integration of 30 x 30 mm profiles
- With 6 holes for mounting
- Self-adhesive

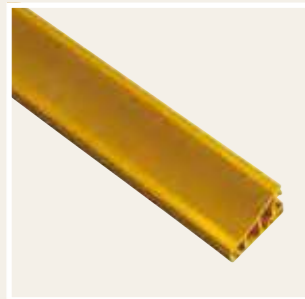

Floor profile

Order no.	Version	Length (mm)
FIFO-BP-1200	Floor profile 1200 mm	1200 mm
FIFO-BP-1800	Floor profile 1800 mm	1800 mm
FIFO-BP-2400	Floor profile 2400 mm	2400 mm
FIFO-BP-3000	Floor profile 3000 mm	3000 mm

- Other lengths up to a maximum of 3 m available on request



Adapter for floor rails

Order no.	Length (mm)	Pack
FIFO-ADAPTER	250	5 pcs.

- Simple connection of the floor profile halves using the adapter



Profile end caps, left and right

Order no.	Version	Length x width x height	Pack
FIFO-PAK-L	Profile end cap, left	45 x 50 x 30 mm	10 pcs.
FIFO-PAK-R	Profile end cap, right	45 x 50 x 30 mm	10 pcs.
FIFO-SCHR-K	Screw set for caps and connectors		20 pcs.

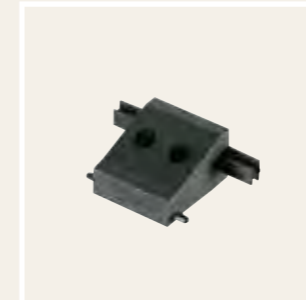

Profile connector

Order no.	Version	Length x width x height	Pack
FIFO-PV	Profile connector	45 x 50 x 30 mm	10 pcs.
FIFO-SCHR-K	Screw set for caps and connectors		20 pcs.

- For additional fixation on long railway tracks



End cap connector

Order no.	Version	Length x width x height	Pack
FIFO-EKV	End cap connector	45 x 50 x 30 mm	10 pcs.
FIFO-SCHR-K	Screw set for caps and connectors		20 pcs.

- Simple connection of the floor profiles to accommodate profiles measuring 45 x 30 mm





FLATRAIL FOR ORDER PICKING AREAS



PVC profile with integrated texture for easy guidance of dollies.

- Self-adhesive
- Robust PVC for heavy-duty use
- Signal colour: Yellow
- Roller set available for use with flatrail



Flatrail for order picking areas

Order no.	Designation	width x height (mm)	Pack
KN-FLAT-04	Flatrail, self-adhesive	75 x 4	By the metre
KN-FLAT-EK	Flatrail-End cap, self-adhesive		2 pcs.
KN-FLAT-ROLLENSET	Roll set		2 pcs.



PARKING BAY ALUMINIUM

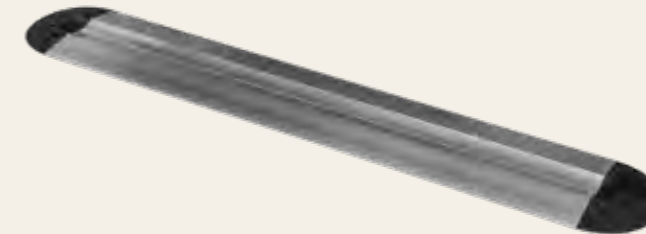

Available in 2 heights and different widths.

- Self-adhesive/screwable
- Targeted provision of the material
- Extremely robust
- Simple attachment
- Clear allocation
- No rolling of the dolly when filling or removing material

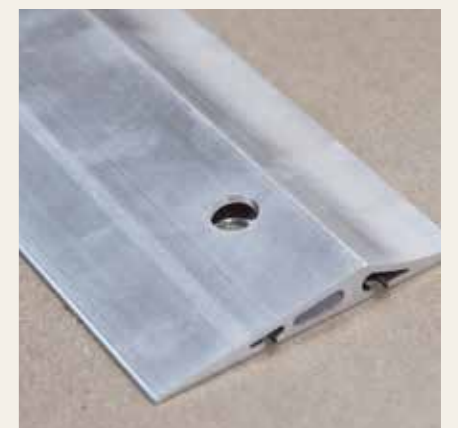
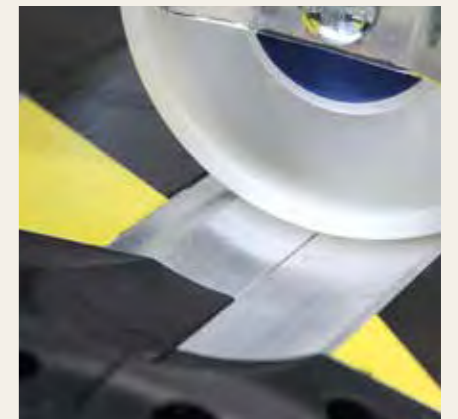
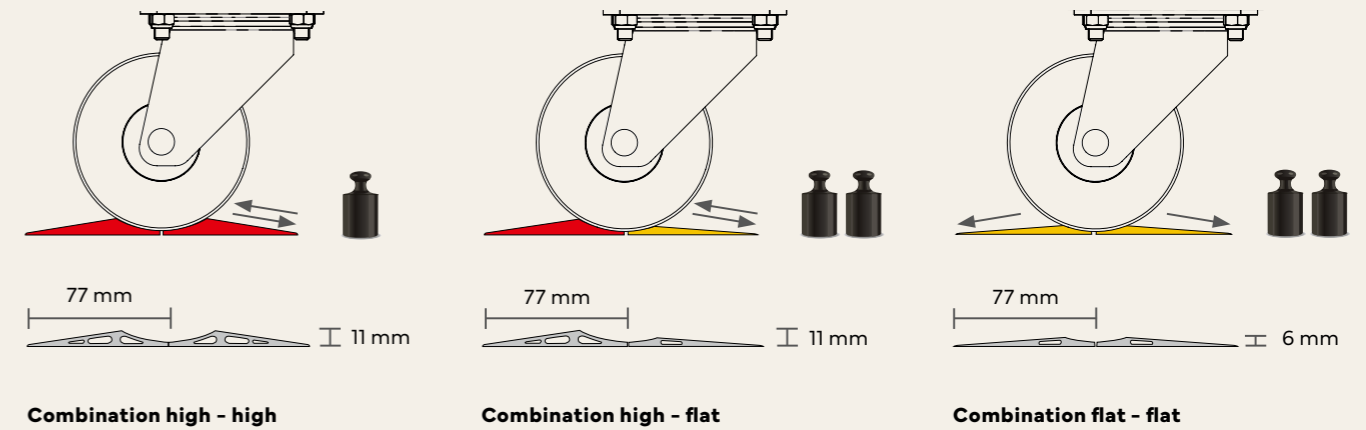



PARKING BAY ALUMINIUM, COMBINATION OPTIONS



Parking bay rail, aluminium, high - high

Order no.	Execution	Length (mm)	Pack
PAB-400	Self-adhesive, aluminium, high - high	400	2 pcs.
PAB-800	Self-adhesive, aluminium, high - high	800	2 pcs.
PAB-1200	Self-adhesive, aluminium, high - high	1200	2 pcs.
PAB-2400	Self-adhesive, aluminium, high - high	2400	2 pcs.
PAB-400-V	Screwable, aluminium, high - high	400	2 pcs.
PAB-800-V	Screwable, aluminium, high - high	800	2 pcs.
PAB-1200-V	Screwable, aluminium, high - high	1200	2 pcs.
PAB-2400-V	Screwable, aluminium, high - high	2400	2 pcs.

- Parking bay for dollies with a roller diameter of **up to 100 mm**



Parking bay rail, aluminium, flat - high

Order no.	Execution	Length (mm)	Pack
PAB-FH-400	Self-adhesive, aluminium, flat - high	400	2 pcs.
PAB-FH-800	Self-adhesive, aluminium, flat - high	800	2 pcs.
PAB-FH-1200	Self-adhesive, aluminium, flat - high	1200	2 pcs.
PAB-FH-2400	Self-adhesive, aluminium, flat - high	2400	2 pcs.
PAB-FH-400-V	Screwable, aluminium, flat - high	400	2 pcs.
PAB-FH-800-V	Screwable, aluminium, flat - high	800	2 pcs.
PAB-FH-1200-V	Screwable, aluminium, flat - high	1200	2 pcs.
PAB-FH-2400-V	Screwable, aluminium, flat - high	2400	2 pcs.

- Parking bay for dollies with a roller diameter of **up to 100 mm**

- Price incl. 2 transition pieces, **1 x left and 1 x right**



Parking bay rail aluminium, flat - flat

Order no.	Execution	Length (mm)	Pack
PAB-F-400	Self-adhesive, aluminium, flat - flat	400	2 pcs.
PAB-F-800	Self-adhesive, aluminium, flat - flat	800	2 pcs.
PAB-F-1200	Self-adhesive, aluminium, flat - flat	1200	2 pcs.
PAB-F-2400	Self-adhesive, aluminium, flat - flat	2400	2 pcs.
PAB-F-400-V	Screwable, aluminium, flat - flat	400	2 pcs.
PAB-F-800-V	Screwable, aluminium, flat - flat	800	2 pcs.
PAB-F-1200-V	Screwable, aluminium, flat - flat	1200	2 pcs.
PAB-F-2400-V	Screwable, aluminium, flat - flat	2400	2 pcs.

- Parking bay for dollies with a roller diameter of **up to 100 mm**

- Price incl. 4 transition pieces, **2 x left and 2 x right**

Price fluctuates greatly.
Please contact us for the current price.



Parking bay service sign, coloured

Order no.	+ colour code	width (mm)	Roll length (m)
PAB-SERVICE-	SG BW GW RW SW	50	50



End caps for parking bay, self-adhesive

Order no.	set
PAB-EK1	4 St

- With 2 perforations for mounting
- Can optionally be fixed with impact dowels
- 1 set = 4 pieces (for 1 x parking bay)



Spacer for end caps

Order no.	Version	width	Roll diameter	Pack
PAB-ZW2	Aluminium spacer	20 mm	101 - 150 mm	2 pcs.
PAB-ZW3	Aluminium spacer	30 mm	150 - 180 mm	2 pcs.
PAB-ZW4	Aluminium spacer	40 mm	From 180 mm	2 pcs.

- Self-adhesive parking bay for dollies with a roller diameter of over **100 mm**

Price fluctuates greatly.
Please contact us for the current price.

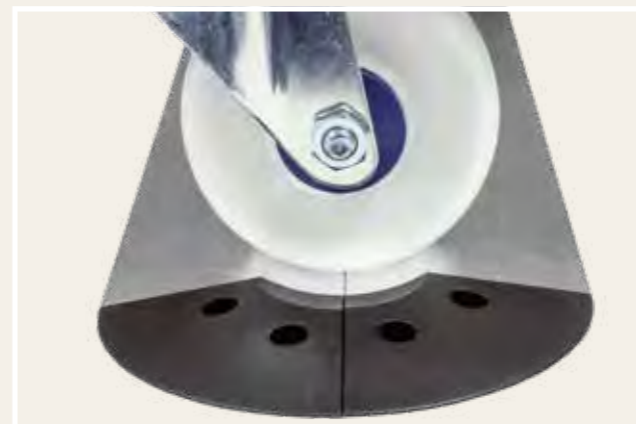

For Roll diameter up to 100 mm



For Roll diameter over 100 mm
(with intermediate piece)



PARKING BAY PLASTIC

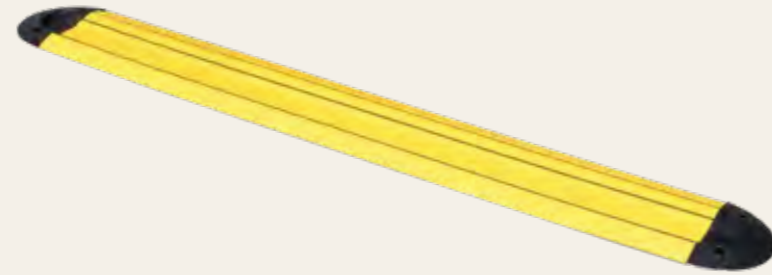

Rollable units should be provided safely and organised in production and logistics. The newly developed KU parking bay is a simple aid for positioning dollies, for example, to save space and prevent them from rolling away on their own without brakes.

- Maximum load: 150 kg
- Can be used simultaneously for different roller diameters
- Can be used immediately due to strong industrial adhesive
- Visual warning effect due to signal colour
- Easy to shorten



Parking bay, Plastic

Order no.	Version	Minimum purchase quantity	Length x width (mm)
PAB-KU-400	Parking bay rail, Plastic, 400 mm	5 pieces per Length	400 x 135
PAB-KU-800	Parking bay rail, Plastic, 800 mm	5 pieces per Length	800 x 135
PAB-KU-1200	Parking bay rail, Plastic, 1200 mm	5 pieces per Length	1200 x 135
PAB-KU-2400	Parking bay rail, Plastic, 2400 mm	5 pieces per Length	2400 x 135
PAB-KU-EK	End cap, self-adhesive, for Parking bay KU	5 pair	





CRATE LIFTER KLT-LIFTER



The electric crate lifter is used for ergonomic positioning of work materials.

- Electric geared motor with brake
- Powder-coated or galvanised surface
- Magnetic control panel with emergency stop switch
- Light sensor infinitely adjustable to working height
- Electrically conductive
- Ready for connection with Schuko plug
- CE labelling



Crate lifter KLT-Lifter

Technical data (model)	KLT-LIFT-2000	KLT-LIFT-2300	KLT-LIFT-3000	KLT-LIFT-3300
Dimensions (without cable) (W x H x D) mm	600 x 1216 x 290	600 x 1516 x 290	700 x 1286 x 290	700 x 1586 x 290
Lifting height (mm)	95 – 1000	95 – 1300	95 – 1000	95 – 1300
Max. Load capacity (N)	2000	2000	3000	3000
Supply	230 V/50 Hz, 16 A	230 V/50 Hz, 16 A	230 V/50 Hz, 16 A	230 V/50 Hz, 16 A
Protection class	IP 54 IEC 529	IP 54 IEC 529	IP 54 IEC 529	IP 54 IEC 529
ESD version	Yes	Yes	Yes	Yes





WORKPLACE SYSTEMS

In today's business world, where precision and efficiency are crucial to a company's success, the optimal design of assembly workstations is of great importance. As time and resources are valuable, we have put together a selection of workstations that not only meet the highest standards of quality and functionality but can also be integrated into your production environment with minimal planning effort.

We offer 2 different profile types, depending on the requirements of your working environment. In addition, we offer a variety of widths and depths to ensure you can choose the right size for your needs. Whether you prefer a static workstation version or need the flexibility of a height-adjustable version, we have the right solution for every requirement.

Another advantage of our assembly workstations is their seamless integration into the rest of the ORGATEX® product portfolio in the area of visual management. By using proven 5S standards, you can equip your workstations in such a way that you not only optimise the production process, but also increase order, cleanliness and efficiency in the workplace.

Advantages

- Fast availability and low planning effort
- Robust and durable product
- Long-term investment security thanks to the modular design of the system
- Expandable with a comprehensive portfolio of intelligent accessories
- Integration of OEE sensors
- Integration of conveyor belts, lifting devices and individual components possible

Facts about workplace design



Working height depends on body size
Working height and body size are directly related to each other



Sitting correctly
Adjustment of work equipment to ensure an upright and natural posture



Standing correctly
Variable adjustable workstation to avoid tension and ensure an upright posture.



Reaching and parts provision
All materials/tools must be easily accessible and within a range of motion



Viewing area and illumination
Unnecessary head and eye movements should be avoided. Optimal lighting conditions support you while working.





WORKPLACE SYSTEMS STATIC



- Work surface height: 750 mm
- Total height of the workstation: 2200 mm
- Depth of the cantilever: 520 mm
- Foot type: Articulated feet
- Table top: melanin resin coated - light grey
- Suspension: C-profile rail, trolley
- Light: LED system light, 39.5 W
- Socket outlet: Multiple socket outlet
- 4 x Schuko socket outlet
- 1 x USB

Workplace systems, static

Order number	Width (mm)	Depth (mm)	Profile type
MASB-1000-600	1000	600	B45
MASB-1200-600	1200	600	B45
MASB-1400-600	1400	600	B45
MASB-1000-700	1000	700	B45
MASB-1200-700	1200	700	B45
MASB-1400-700	1400	700	B45
MASI-1000-600	1000	600	I40
MASI-1200-600	1200	600	I40
MASI-1400-600	1400	600	I40
MASI-1000-700	1000	700	I40
MASI-1200-700	1200	700	I40
MASI-1400-700	1400	700	I40



WORKPLACE SYSTEMS HEIGHT-ADJUSTABLE

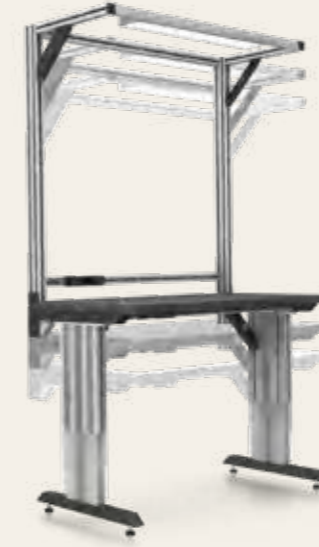

- Work surface height: 700 - 1000 mm
- Total height of the AP: 2200 - 2500 mm
- Depth of the cantilever: 520 mm
- Foot type: Articulated feet
- Table top: melanin resin coated - light grey
- Suspension: C-profile rail, trolley
- Lifting unit: SL 2430 EU 2
- Light: LED system light, 39.5 W
- Socket outlet: Multiple socket outlet
- 4 x Schuko socket outlet
- 1 x USB

Workplace systems height-adjustable

Item number	Width (mm)	Depth (mm)	Profile type
MASB-V-1000-600	1000	600	B45
MASB-V-1200-600	1200	600	B45
MASB-V-1400-600	1400	600	B45
MASB-V-1000-700	1000	700	B45
MASB-V-1200-700	1200	700	B45
MASB-V-1400-700	1400	700	B45
MASI-V-1000-600	1000	600	I40
MASI-V-1200-600	1200	600	I40
MASI-V-1400-600	1400	600	I40
MASI-V-1000-700	1000	700	I40
MASI-V-1200-700	1200	700	I40
MASI-V-1400-700	1400	700	I40



SAFETY

It doesn't take a lot of bad luck for an industrial accident to turn into a cascade of further disasters. Production comes to a standstill, ordered goods cannot be delivered, customers become angry, insist on contract fulfilment or, in the worst case, terminate the cooperation. It's just as well that you can achieve a lot for the well-being of your employees and the safety of your company with a few simple measures. And of course we offer them.



[katalog.orgatex.com/
sicherheit](https://katalog.orgatex.com/sicherheit)

Anti-slip products

Anti-slip-Tape UniversalGrip	306
Anti-slip-Tape ProGrip	307
Anti-slip-Tape FlexGrip	308
Anti-slip-Tape NanoGrip	309
Anti-slip-Tape LongLifeGrip	310

Stair nosing profiles

Stair nosing profile – Slim	312
Stair nosing profile – Universal	314
Stair nosing profile – Heavy Duty	315

Photoluminescent marking

Photoluminescent tapes	318
------------------------	-----

Safety and Information signs

Norms and standards	322
Escape signs	324
Flag and angle signs	326
Fire safety signs and angle signs	328
Information signs	330
LongLife floor signs 600 mm	332
Half and quarter circles 900 mm	336
LongLife crosswalk	338

Customised printing

339

Warning signs

LongLife fabric tape	342
----------------------	-----

From 340

Safety is about the same thing as efficient work processes: awareness. Your employees must always be aware of possible risks, even in the hustle and bustle of everyday work life and despite focussing on their tasks. It is also about visual management and you are in good hands with us.

We have greatly expanded our range in this key area. From high-strength, durable anti-slip tape that prevents tripping accidents to safety signs that are clearly visible from afar – we offer a wide range of safety products.

You can easily find effective solutions to minimise the risk of accidents and injuries in the workplace.

We have channelled all our experience with a range of different companies from the most diverse industries in order to offer you a wide range of solutions that not only cover practically all hazard areas but have also proven themselves in day-to-day operations. And if you are missing something – just contact us. We will find a solution.



ANTI-SLIP-PRODUCTS

On the following pages, you will find the right anti-slip solutions to help prevent accidents and falls at the workplace and in other areas. Tripping, falling and slipping are among the most common causes of accidents in companies. Floors should therefore be slip-resistant. This is specified in ASR A1.5. Anti-slip tapes are categorised into 5 R classes, with R9 being the lowest and R13 the highest slip resistance.

Our anti-slip tapes have been carefully developed to make slippery surfaces more slip-resistant and ensure the safety of your employees and customers. Whether it is for high frequencies, rough surfaces or clean rooms, you will find the right products here. They are characterised by reliability, durability and simple use. Create a non-slip environment with our anti-slip tapes and help to reduce accidents and promote the safety of everyone involved.

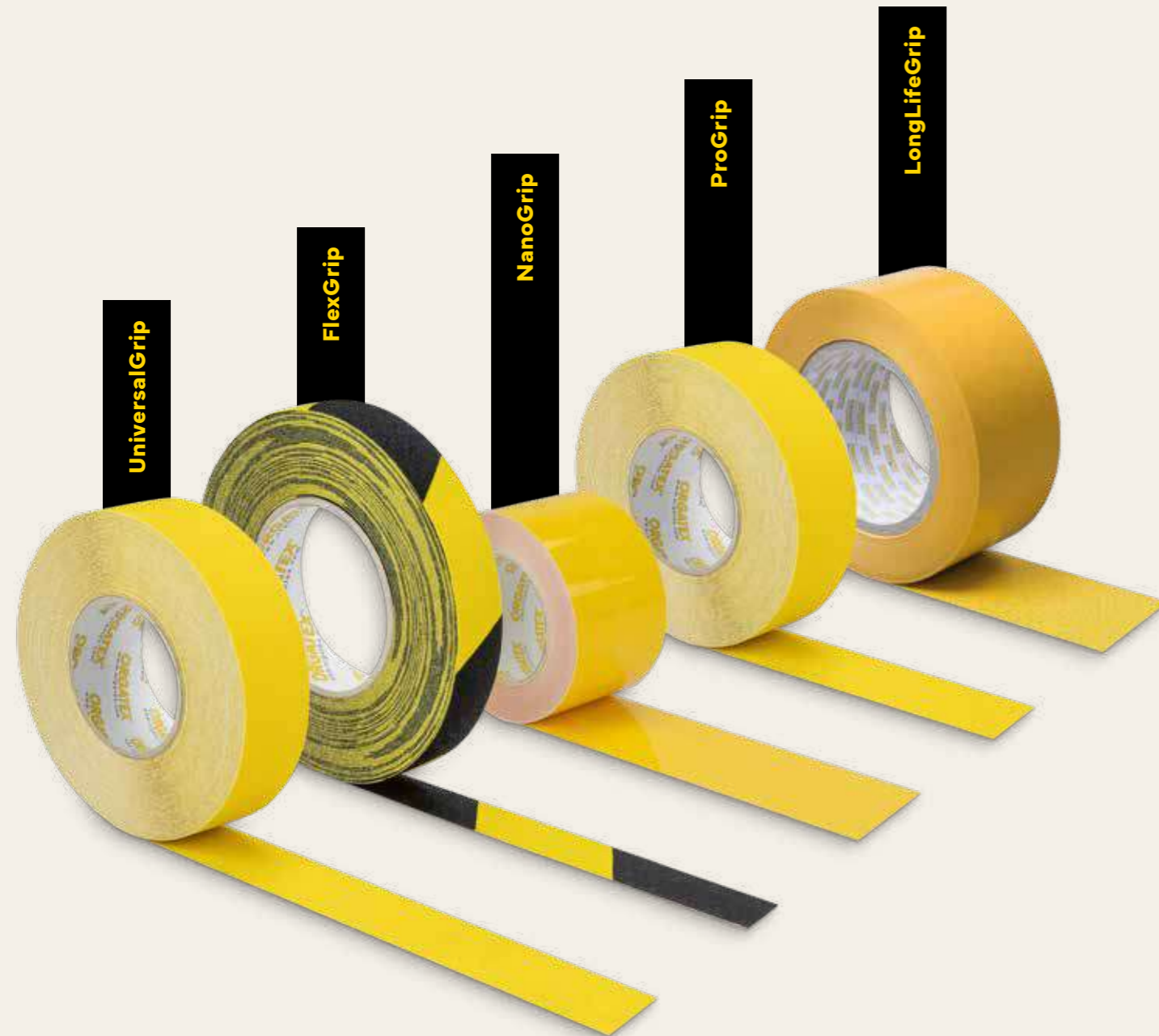

Product	Anti-slip-Tape UniversalGrip	Anti-slip-Tape FlexGrip	Anti-slip-Tape NanoGrip	Anti-slip-Tape ProGrip	Anti-slip-Tape LongLifeGrip
Slip class	R13	R13	R10	R13	R11
Glue	Acrylate	Acrylate	Acrylate	Acrylate	Synthetic rubber
Surface	Rough	Rough	Fine	Rough	Medium
Field of application	Inside	Inside	Inside	Inside	Inside/outside
Properties	Wide range of colours, versatile in use	Adaptable	Non-abrasive, easy to clean	Thick, coarse surface	Wear-resistant, highly adhesive
Application	Medium to high load	Uneven substrates and chequer plates	Hygiene and cleanroom areas	High stress, high soiling	Rough surfaces in outdoor areas
Widths (mm)	50, 75, 100	50, 75	50, 75, 100	50,75,100	50, 75, 100
Number of colours	15	3	8	2	7
Roll length (m)	18	18	10	18	25
Processing temperature	≥ 12 °C	≥ 12 °C	≥ 12 °C	≥ 12 °C	≥ 12 °C
Temperature range	-15 °C bis +70 °C	-23 °C bis +65 °C	-20 °C bis +70 °C	-15°C bis +70°C	-20 °C bis +70 °C

Application*	Anti-slip-Tape UniversalGrip	Anti-slip-Tape FlexGrip	Anti-slip-Tape NanoGrip	Anti-slip-Tape ProGrip	Anti-slip-Tape LongLifeGrip
Inputs	✓✓✓	✓✓	-	✓✓✓	✓✓✓
Stairs	✓✓✓	✓✓	-	✓✓✓	-
Ramps	✓✓✓	✓✓✓	-	✓✓✓	-
Footpaths	✓✓✓	✓✓	-	✓✓✓	✓✓✓
Rough surfaces	-	✓✓✓	-	-	✓✓✓
Metallic surfaces	✓✓✓	✓✓	✓✓	✓✓✓	✓✓
Public buildings	✓✓✓	✓✓	-	✓✓	✓✓
Workshop floors	✓✓	✓✓	-	✓✓✓	✓✓✓
Production areas	✓✓✓	✓✓✓	-	✓✓✓	✓✓✓
Food and clean rooms	-	-	✓✓✓	-	-
Chequer plates	-	✓✓✓	-	-	-
Outdoor areas	-	-	-	-	✓✓✓

*These are examples and recommendations. Observe the requirements of the ASR.
2 points: good / 3 points: excellent / dash: unsuitable



ANTI-SLIP-TAPE UNIVERSALGRIP



UniversalGrip is the perfect solution for anyone looking for effective slip protection. With a wide range of colour options, it adapts effortlessly to any environment and can therefore be used to mark hazardous areas. Thanks to its high slip class R13, the tape offers reliable grip on various surfaces and significantly minimises the risk of tripping.

Developed for medium to heavy-duty use, this anti-slip tape is ideal for high-traffic areas such as stairs, ramps, walkways and production areas. Its hard-wearing nature ensures long-lasting performance, even in demanding conditions.

- Slip resistance R13
- For medium to high loads
- Great variety of colours
- Customised widths possible
- Suitable for smooth indoor floors



Anti-slip-Tape UniversalGrip, 18 m

Order no.	Colour code														
LGSV50-UN	-01	-02	-03	-04	-04NE	-05	-06	-07	-08NE	-09	-88	-NL	-NLS	-PU	-SG
LGSV75-UN	-01	-02	-03	-04	-04NE	-05	-06	-07	-08NE	-09	-88	-NL	-NLS	-PU	-SG
LGSV100-UN	-01	-02	-03	-04	-04NE	-05	-06	-07	-08NE	-09	-88	-NL	-NLS	-PU	-SG

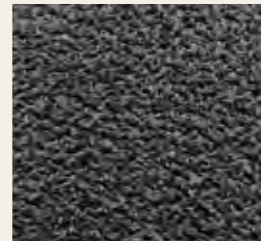

ANTI-SLIP-TAPE PROGRIP



ProGrip is our anti-slip tape for high-traffic areas that require reliable anti-slip protection. With its robust and coarse surface structure, the tape provides exceptional grip, even under demanding conditions. Whether in heavily frequented production areas, warehouses or public areas – this tape effortlessly masters high levels of strain and stays in place and it extremely resistant to soiling and wear.

Thanks to its slip class R13, our anti-slip tape significantly minimises the risk of falling and ensures the safety of your employees and visitors.

- Slip resistance R13
- Ideal for high footfall and a high degree of soiling
- Suitable for smooth indoor floors



Anti-slip-Tape ProGrip, 18 m

Order no.	Colour code	
LGSV50-P	-04	-06
LGSV75-P	-04	-06
LGSV100-P	-04	-06





ANTI-SLIP-TAPE FLEXGRIP



The FlexGrip is the perfect solution for use on uneven and rough surfaces. Due to its adaptable aluminium layer, it adheres perfectly to textured surfaces such as chequer plates and stairs without losing its adhesive strength. With an R13 slip class coating, the tape offers reliable slip resistance that remains intact even under demanding conditions.

Whether in industrial plants, warehouses, on construction sites or in other harsh environments – our anti-slip tape offers an effective safety solution that is easy to use and provides long-term protection against accidents.

- Slip resistance R13
- Especially for uneven surfaces
- Excellent adaptation to chequer plate
- Suitable for indoor use



Anti-slip-Tape FlexGrip, 18 m

Order no.	Colour code		
	Yellow	Black	Yellow/Black
LGSV50-FX	-04	-06	-SG
LGSV75-FX	-04	-06	-SG



ANTI-SLIP-TAPE NANOGRIP



NanoGrip was developed specifically for use in cleanrooms and fulfils the highest standards of cleanliness and safety. With its non-abrasive layer, it also offers excellent slip resistance (slip class R10). Due to its extra-thin yet tear-resistant nature, it enables seamless integration into the cleanroom environment.

The anti-slip tape is extremely easy to clean, which maintains the cleanliness and hygienic standard of the cleanroom. With this anti-slip tape, you can create a safe working environment and significantly reduce the risk of falls and accidents in your cleanroom.

- For hygiene, food and cleanroom areas
- Easy to clean, extra thin and tear-resistant
- Slip resistance R10
- Wide range of colours and individually printable
- Suitable for smooth indoor floors



Anti-slip-Tape NanoGrip, 10 m

Order no.	Colour code							
	Red	White	Yellow	Green	Blue	Light Green	Red/White	Yellow/Black
LGSV50-N	-01	-02	-04	-05	-07	-NL	-RW	-SG
LGSV75-N	-01	-02	-04	-05	-07	-NL	-RW	-SG
LGSV100-N	-01	-02	-04	-05	-07	-NL	-RW	-SG





LONGLIFE FLOOR MARKING TAPE GRIP



Durable floor marking

Save yourself the effort of marking floors with real paint! With the LongLife-Grip with anti-slip effect, you can create hard-wearing floor markings easily and quickly. The non-slip and retroreflective surface is suitable for indoor and outdoor areas. The extra-strong floor marking tape also adheres to surfaces such as concrete, tiles and asphalt. Due to its permanent adhesion, it can also be driven on, making it a safe solution for use in your storage area. Mark cleverly and immediately!

- Suitable for smooth and textured floors
- For indoor and outdoor areas
- Hardwearing and self-adhesive
- Non-slip and retroreflective
- Can be used outdoors with LongLife Primer
- Wear resistant
- Suitable for various surfaces
- Immediately accessible



LongLife Floor Marking Tape Grip

Version	Format (Width) (mm)	Order no.	+ Colour code	Roll length (m)
Floor Marking Tape	50	LGGRIP50-	01 02 04 05 06 07 SG	25
Floor Marking Tape	75	LGGRIP75-	01 02 04 05 06 07 SG	25
Floor Marking Tape	100	LGGRIP100-	01 02 04 05 06 07 SG	25



STAIR NOSING-PROFILES

Our stair nosing profiles increase visibility and consequently also safety at the edges of steps. Thanks to anti-slip coverings with an R13 anti-slip coating, slip resistance is also increased. There are 3 versions available depending on the load and requirements. In production, where things are often hectic, the safety of employees is of the utmost importance. Our stair nosing profiles with anti-slip coating provide a secure grip on stairs and ensure that slippery surfaces no longer pose a risk.

We offer a wide range of stair nosing profiles that have been specially developed for different frequencies. Whether you have light use in offices or heavy use on factory floors, we have the right profile for your requirements.

Another advantage of our stair nosing profiles is that they are available in different coloured anti-slip coatings. These not only contribute to improved visibility and orientation, but also offer the option of colour-matching the profiles to the surroundings or marking certain areas.

The installation of our stair nosing profiles is simple and straightforward. They adhere securely to the steps and offer a long-lasting solution for your safety needs.

Protect your employees from potential accidents and ensure a safe working environment in your production and on stairs.





STAIR NOSING PROFILE SLIM

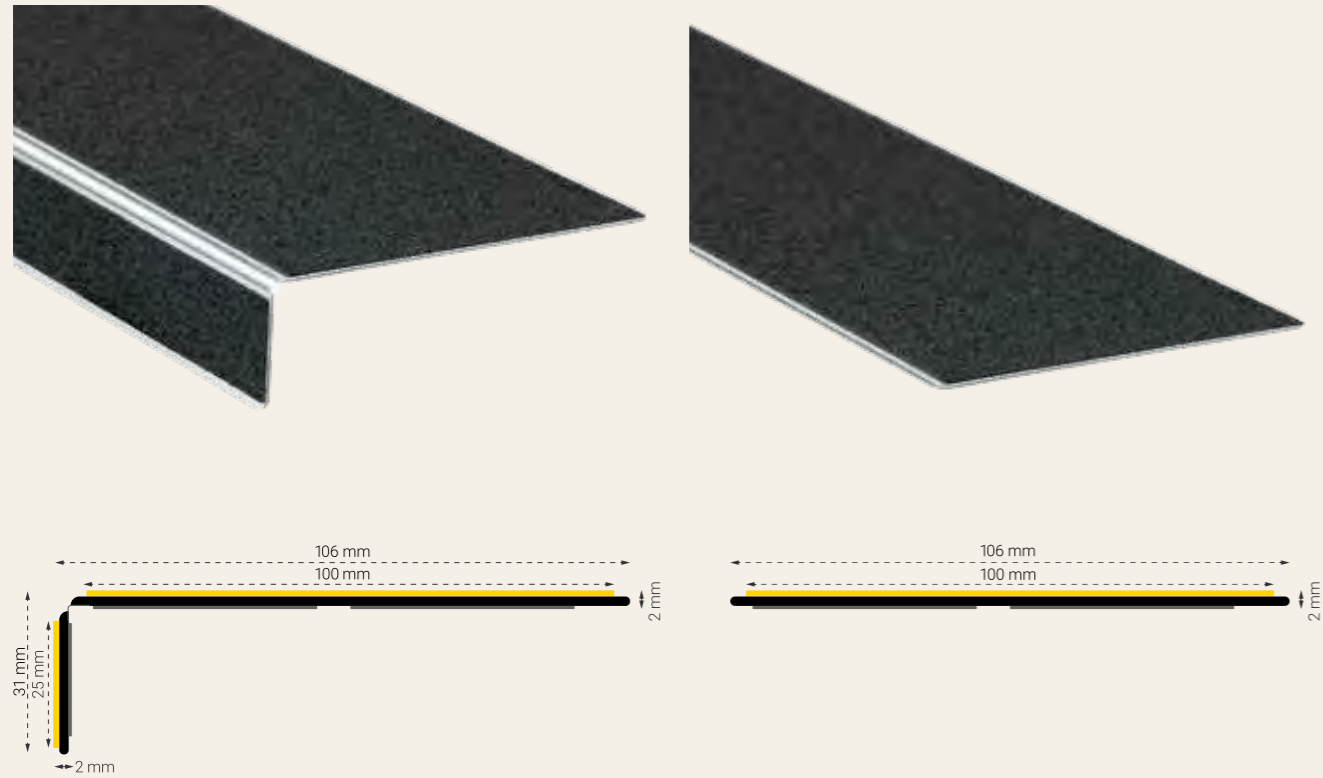

The slim version of the profile combines the advantages of increased slip resistance with a discreet design. This means that high-profile areas such as the foyer can be equipped. The highest slip class R13 also offers safety in various production areas, even with high footfall. Different coloured surfaces ensure guaranteed visibility. You can also choose between 3 lengths to optimise the safety of your staircase area. An anti-slip tile version is also available.

- Slip resistance R13
- For indoor use
- Wear-resistant and slip-resistant, even with high traffic
- Gluing or screwing (drill hole Ø 5mm)
- Aluminium composite
- Other colours on request

Stair nosing profile Slim

Version	Width (mm)	Order no.	+ Colour code					
			06	SG	PH	NLS2	NLAS	
Stair nosing slim	600	TKPLD600-	PU	06	SG	PH	NLS2	NLAS
Stair nosing slim	800	TKPLD800-	PU	06	SG	PH	NLS2	NLAS
Stair nosing slim	1000	TKPLD1000-	PU	06	SG	PH	NLS2	NLAS
Stair nosing slim plate	600	TKPLD600-V2-	PU	06	SG	PH	-	NLAS
Stair nosing slim plate	800	TKPLD800-V2-	PU	06	SG	PH	-	NLAS
Stair nosing slim plate	1000	TKPLD1000-V2-	PU	06	SG	PH	-	NLAS

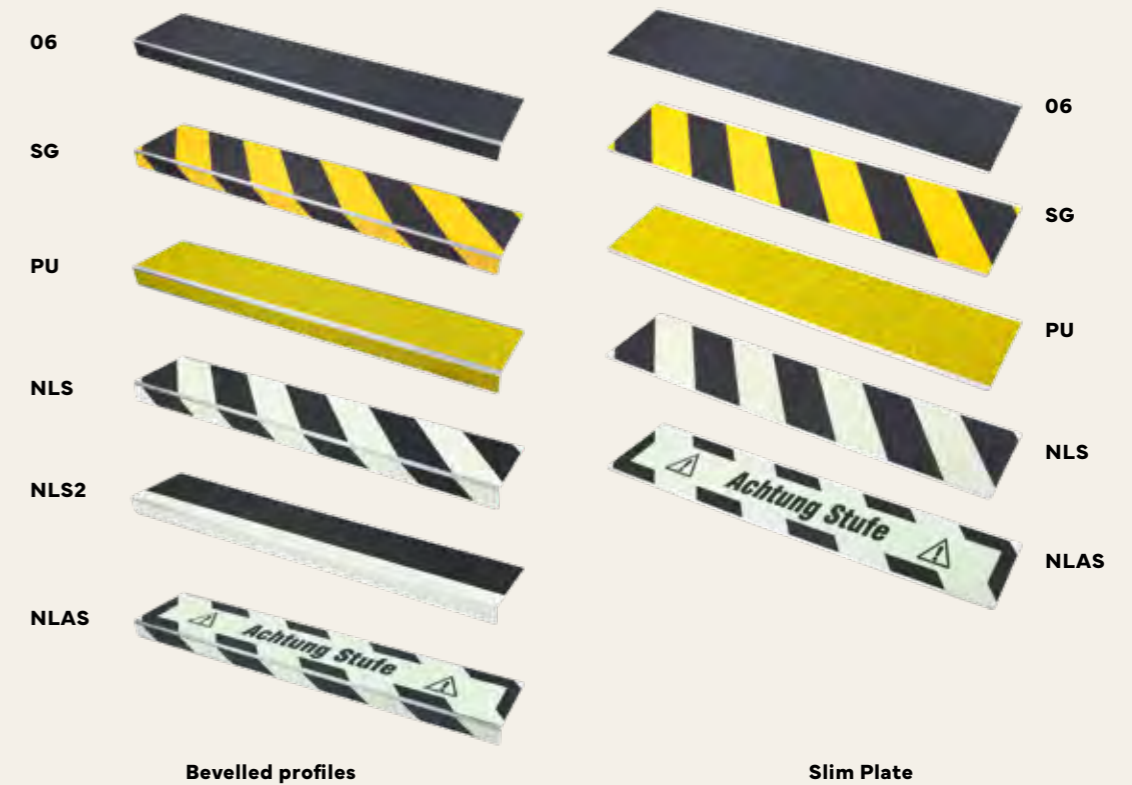



STAIR NOSING PROFILE UNIVERSAL



The universal version of the profile is our all-rounder among stair nosing profiles. The 2.6 mm thick aluminium profile is wear-resistant even with high traffic and ensures slip resistance with an R13 slip class coating.

The product can be used indoors and outdoors and is fixed in place with screws. Broken steps and worn edges can be easily concealed and damage concealed. Different coloured surfaces ensure guaranteed visibility. You can also choose between 3 lengths to provide optimum protection for your staircase area

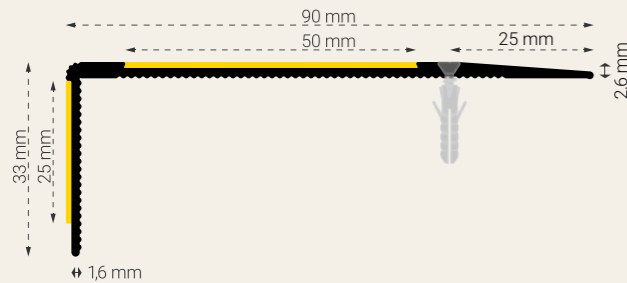

- Slip resistance R13
- For indoor and outdoor use
- Wear-resistant and slip-resistant, even with high traffic
- Gluing or screwing (hole diameter: \varnothing 5.5 mm)
- Aluminium
- Other colours on request



Stair nosing profile Universal

Version	Width (mm)	Order no.	+ Colour code			
			06	SG	NLS	
Stair nosing universal	600	TKPUN600-	PU	06	SG	NLS
Stair nosing universal	800	TKPUN800-	PU	06	SG	NLS
Stair nosing universal	1000	TKPUN1000-	PU	06	SG	NLS

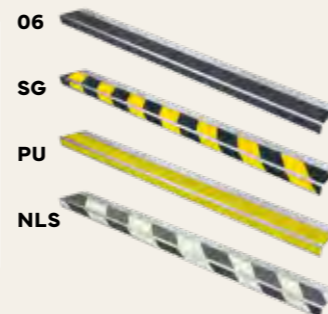

STAIR NOSING PROFILE HEAVY DUTY

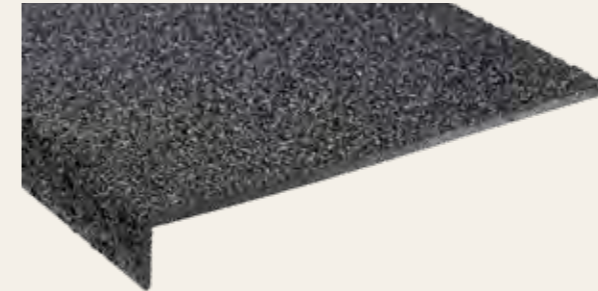

The heavy-duty version of the profile is extremely wear-resistant and suitable for high frequencies. The 3.8 mm thick GRP profile (glass fibre reinforced special plastic) has a sealed aluminium oxide grain and a R13 slip class coating for high slip resistance. The product can be used indoors and outdoors and is fixed in place with screws or a mounting adhesive. Broken steps and worn edges can be easily covered and damage concealed. With the appropriate accessories, the profiles can also be attached to grating stairs. You can also choose between 3 lengths to provide optimum protection for your staircase area.

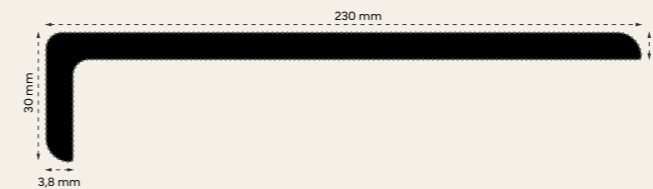

- Slip resistance R13
- For indoor and outdoor use
- Wear-resistant and slip-resistant, even with high traffic
- Gluing or screwing
- Glass fibre reinforced special plastic



Stair nosing profile Heavy Duty

Version	Width (mm)	Order no.	+ Colour code	
			06	SG
Stair nosing heavy duty	600	TKPHD600-	06	SG
Stair nosing heavy duty	800	TKPHD800-	06	SG
Stair nosing heavy duty	1000	TKPHD1000-	06	SG
Spring clip for the assembly		TKP-FD		





LUMINESCENT MARKING



Guide your employees safely to emergency exits and escape routes, even in the dark. Our tapes and cut-to-size sheets are characterised by a hard-wearing and durable material. The products have an extra high luminance of 200/25 mcd/m² in accordance with DIN 67510 (class C). In addition, imprints such as arrows or signposts provide clear guidance through dark environments. The integrated version combines a coloured signal effect in the light and luminescent effects in the dark.

- Luminosity class C
- Luminance 200/25 mcd/m²
- Hardwearing
- For indoor arease

ORGATEX® Safety, luminescent

Version	Width (mm)	Order no.	Packaging unit
Arrow	90	LGPF-NL	10
Dot	50	LGR-50-P-NL	10
Dot	75	LGR-75-P-NL	10
Stair angle	37	LG-37-L-NL	5 pair
Stair angle	47	LG-47-L-NL	5 pair
Dot with arrow	90	LGN-90-PP	20





LUMINESCENT TAPES



Guide your employees safely to emergency exits and escape routes, even in the dark. Our tapes and blanks are characterised by a durable and long-lasting material. The products have an extra high luminance of 200/25 mcd/m² in accordance with DIN 67510 (class C). In addition, imprints such as arrows or way markers provide clear guidance through dark environments. The integrated version combines a coloured signal effect in the light and luminescent effects in the dark.

- Luminosity class C
- Luminance 200/25 mcd/m²
- Hardwearing
- For indoor areas



Luminescent tapes

Version	Width (mm)	Order no.	+ Colour code								Roll length (m)
			■	■	■	■	■	■	■	■	
Luminescent tape	50	LGNL50									10
Luminescent tape	75	LGNL75									10
Escape route right	50	LGNL50-FW-R									10
Escape route right	75	LGNL75-FW-R									10
Escape route left	50	LGNL50-FW-L									10
Escape route left	75	LGNL75-FW-L									10
Directional arrow	50	LGNL50-PF									10
Directional arrow	75	LGNL75-PF									10
Light strip, integrated	50	LGNL50-	01	02	04	05	07	08			10
Light strip, integrated	75	LGNL75-	01	02	04	05	07	08			10

Luminescent anti-slip tape

UniversalGrip, luminescent	50	LGSV50-UN-								NL	18
UniversalGrip, luminescent	75	LGSV75-UN-								NL	18
UniversalGrip, luminescent	100	LGSV100-UN-								NL	18
UniversalGrip, luminescent, hatched	50	LGSV50-UN-								NLS	18
UniversalGrip, luminescent, hatched	75	LGSV75-UN-								NLS	18
UniversalGrip, luminescent, hatched	100	LGSV100-UN-								NLS	18
NanoGrip, luminescent	50	LGSV50-N-								NL	10
NanoGrip, luminescent	75	LGSV75-N-								NL	10
NanoGrip, luminescent	100	LGSV100-N-								NL	10

Further information on the photoluminescent anti-slip tapes can be found on the corresponding product pages.



SAFETY AND INFORMATION SIGNS

Safety and information signs – clear messages for a safe environment.

Our signs have luminance class C with a luminance of 200/25 mcd/m², ensuring that they are clearly visible even in poor lighting conditions.

We offer various formats to ensure you find the right safety and information sign for your requirements. Whether it's small signs for offices or large safety signs for industrial facilities, we have the right solutions for you.

Our signs are available with a variety of symbols that enable clear and universal communication. From warnings and fire safety symbols to safety regulations, our signs support an effective safety culture in your organisation.

We also offer you the option of customised printing. Personalise your signs with specific instructions or other relevant information to create tailor-made solutions for your business.





NORMS AND STANDARDS

In Germany, company safety standards are based on ISO 7010 and ASR A1.3, which has replaced the main parts of the older regulation for safety and health at work (BGV A8 - Accident Prevention). The BGV itself has been invalid since 2012 and only applies in certain areas. This change was due to increasing international cooperation between companies. In order to comply with global standards, Germany and other European countries have adopted the international safety symbols in accordance with ISO 7010.

The use of the current safety labelling in accordance with ASR A1.3 and ASR A2.3 complies with the legally binding Workplace Ordinance (ArbStättV). If a company chooses an alternative solution, a risk assessment must first be carried out by the company. This ensures that employees receive at least the same level of health and safety protection.

ISO 7010

- International standard defined by the European Committee
- Adoption of the international standard in Europe and in Germany (DIN EN ISO 7010)
- Standardised definition of safety labelling, also beyond the borders of single European states.

ASR A1.3

- Technical rule for workplaces (safety and health protection labelling)
- Replacement of the old regulation according to BGV A8
- Adoption of the standards set out in DIN EN ISO 7010 defined safety markings
- With this regulation, employers fulfil their obligation to label workplaces safely.



BGV A8

- Employer's Liability Insurance Association regulation for safety and health at work
- Regulation of health protection and safety labelling in the workplace
- Currently only valid in some areas
- The main contents are now covered by ASR A1.3
- Security labelling according to BGV A8 only possible in conjunction with a risk assessment



THE MEANING AND COLOURS OF THE SAFETY SIGNS

ASR A1.3 specifies the requirements for safety and health protection labelling in workplaces. According to Section 3a of the Workplace Ordinance in conjunction with Section 1.3 of the appendix, safety and health protection labels must be used if the risks to safety and health cannot otherwise be avoided or cannot be sufficiently minimized. The ASR A1.3 also specifies the design

of escape and rescue plans in accordance with Section 4 Paragraph 4 of the Workplace Ordinance. DIN 4844-1 also specifies the detection distances and colour requirements. The RAL colours are determined by DIN 5381 "identifying colours". There is also ISO 3864 "Graphic symbols - safety colours and safety symbols", which records pictograms, colours and their design.

Type	Format	Safety colour	Contrasting colour	Colour of pictograph	Meaning according to ASR A1.3	Information	Example
Fire equipment sign	Rectangle	RAL 3001 Signal red	RAL 9003 Signal white	RAL 9003 Signal white	Fire alarm and fire extinguishing equipment	Equipment and location	
Emergency sign	Rectangle	RAL 6032 Signal green	RAL 9003 Signal white	RAL 9003 Signal white	Help, rescue, safety	Doors, notices, paths, rooms	
Mandatory sign	Circle	RAL 5005 Signal blue	RAL 9003 Signal white	RAL 9003 Signal white	Mandate	Special behaviour or activity	
Prohibition sign	Circle	RAL 3001 Signal red	RAL 9003 Signal white	RAL 9004 Signal black	Prohibition, danger	Dangerous behaviour, stop, evacuation	
Warning sign	Triangle	RAL 1003 Signal yellow	RAL 9004 Signal black	RAL 9004 Signal black	Warning of risks or danger	Caution, danger, inspection	

Viewing distance of safety signs

Hand, fire, and hearing protection signs		Warning sign		Emergency signs	
Diameter (mm)	max. viewing distance (m)	Side length (mm)	max. viewing distance (m)	Size (B x H) (mm)	Max. viewing distance (m)
50	2	50	1	100 x 100	10
100	4	100	3	150 x 150, 300 x 150	15
200	8	200	6	200 x 200, 400 x 200	20
300	12	300	9	300 x 300, 600 x 300	30
400	16	400	12		
600	24	600	19		

Rescue and fire safety signs must be made of luminescent material if there is insufficient safety lighting. According to ASR A1.3 point 3.17, a photoluminescent safety sign is a safety sign that is energised by light and remains illuminated after the general lighting has failed without any further energy supply. Luminescent signs are subject to DIN 67510, which specifies the minimum luminance of the material. The luminance specifies the level of illumination that the safety sign reflects after the light source has been removed and is given in millicandela per square metre (mcd/m²). The minimum values are determined after 2, 10, 30 and 60 minutes after the end of the excitation period in the standard.

Depending on these values, the classification into classes A to C in accordance with DIN 67510-1, with class C representing the highest value takes place. Luminescent safety signs must at least fulfil the requirements of DIN 67510-1, Class C. As this is merely a guideline, the symbols with reduced luminance (old standard) can continue to be used. In this case, however, a risk assessment must be carried out to ensure that the requirements are met. It is advisable to switch to luminance class C labelling in order to comply with the ASR without any problems and to act with legal certainty in terms of the presumption of conformity.

Luminosity class	Field of application	Luminance 10 min/60 min	ORGATEX®-Product
A	Very well-lit rooms with permanent lighting and/or daylight, e.g. offices with windows	23/3 mcd/m ²	
B	Rooms with bright continuous lighting during operating hours: Hazardous areas can be easily recognised in these work areas.	50/7 mcd/m ²	
C	Rooms with subdued or only intermittent lighting. All buildings/rooms subject to ASR A3.4/3: Hospitals, airports, large department stores, hotels, power stations, event venues, factories and warehouses, corridors.	140/20 mcd/m ²	200/25 mcd/m ²
D	For areas with unfavourable lighting situations and special safety requirements. Special solutions in accordance with ASR for ships, tunnels, etc. For internal claims of the client.	260/35 mcd/m ²	



EMERGENCY SIGNS

Guide your employees safely to emergency exits and escape routes. Our signs are characterised by a hard-wearing and durable material. The products have an extra high luminance of 200/25 mcd/m² in accordance with DIN 67510 (class C). Customised products can be produced according to your wishes. Angled and flag signs ensure the necessary visibility even in elongated rooms.

- Luminosity class C
- Luminance 200/25 mcd/m²
- Large number of symbols
- Different formats
- Durable plastic
- Customised printing

RT-SCHILD-400- 140 x 400 mm

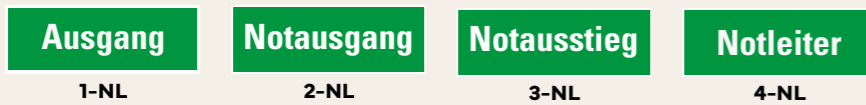

RT-SCHILD-300- 150 x 300 mm

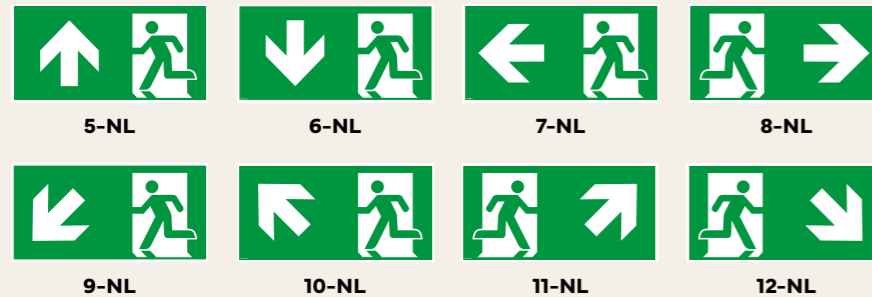

RT-SCHILD-200- 200 x 200 mm



Accessories for assembly



Double-sided foam tape

For mounting and installation
Order no.
PE-FOAM



FLAG AND ANGLE SIGNS

Angle and flag signs provide the necessary visibility even in long rooms. Using the flag signs, you can combine the blank sign with our luminescent films. This allows you to determine the position of the sign on the wall.

- Luminosity class C
- Luminance 200/25 mcd/m²
- Large number of symbols
- Different formats
- Durable plastic
- Customised printing

RTF-SCHILD-300-

150 x 300 mm



5-NLF



6-NLF



7-NLF



8-NLF



9-NLF



10-NLF



11-NLF



12-NLF

RTW-SCHILD-200-

200 x 200mm



15-NL



16-NL



17-NL



18-NL



19-NL



20-NL



Accessories for assembly



Double-sided foam tape

For mounting and installation
Order no.
PE-FOAM



FIRE SAFETY SIGNS AND ANGLE SIGNS

Guide your employees safely to emergency exits and escape routes. Our signs are characterised by a hard-wearing and durable material. The products have an extra high luminance of 200/25 mcd/m² in accordance with DIN 67510 (class C). Customised products can be produced according to your wishes. Angle and flag signs provide the necessary visibility even in long rooms.

- Luminosity class C
- Luminance 200/25 mcd/m²
- Large number of symbols
- Different formats
- Durable plastic
- Customised printing

BS-SCHILD-297- 105 x 297 mm

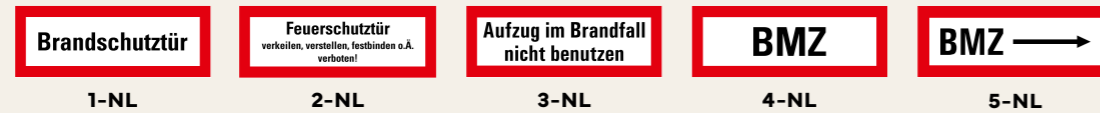

BS-SCHILD-200- 200 x 200 mm



BSW-SCHILD-200- 200x 200 mm



Accessories for assembly



Double-sided foam tape

For mounting and installation
Order no.
PE-FOAM



INFORMATION SIGNS

Prevent your employees from being put at risk by using information signs. Clear instructions ensure correct behaviour in the production environment. Our signs are characterised by a hard-wearing and durable material. Customised designs can be produced according to your wishes.

- Large number of symbols
- Different formats
- Durable plastic
- Customised printing

HW-SCHILD-300- 200 x 300 mm

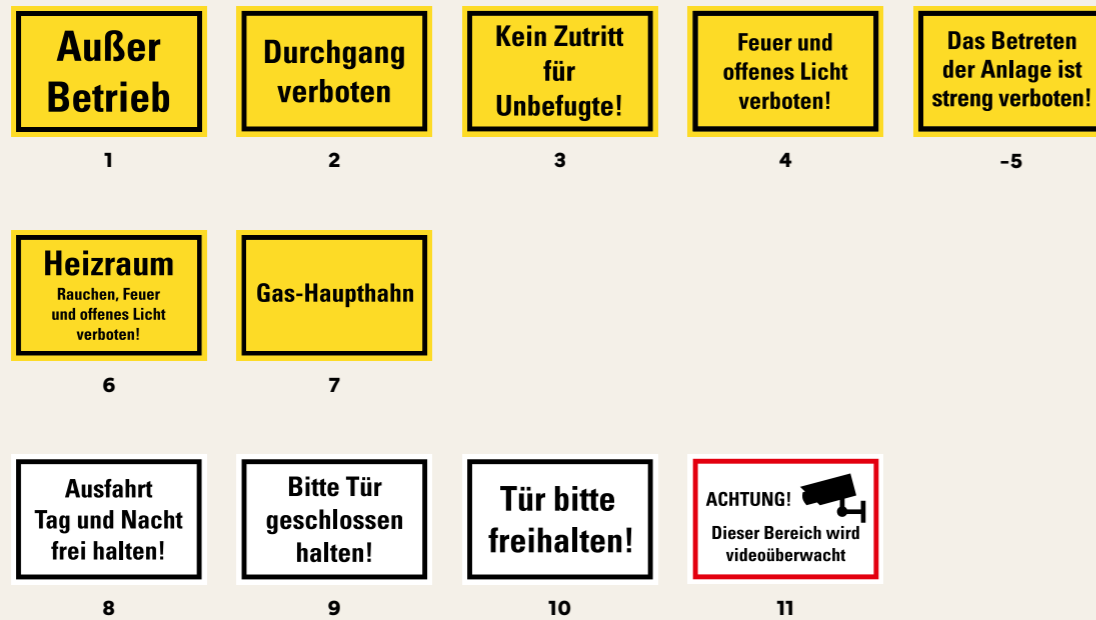

Accessories for assembly



Double-sided foam tape

For mounting and installation
Order no.
PE-FOAM



LONGLIFE FLOOR MARKING 600 MM

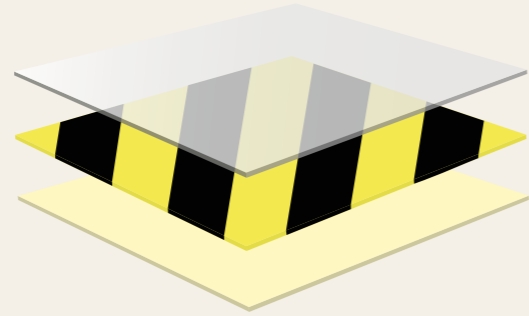

Warning and mandatory signs comply with the following standards and regulations in accordance with ASR A1.3.

- Made from PVC
- Full-surface adhesive backing
- Increasing occupational safety
- Simple attachment
- Excellent adhesion
- High level of step security
- Trafficable
- High warning and information effect
- **Further symbols on request**

3-layer structure (back-printed):

Multi-coloured LongLife floor markings consist of a transparent film that is backprinted on the reverse side and coated with a special adhesive. This means that the coloured printed image is located between the film and the adhesive and is protected from wear and tear.

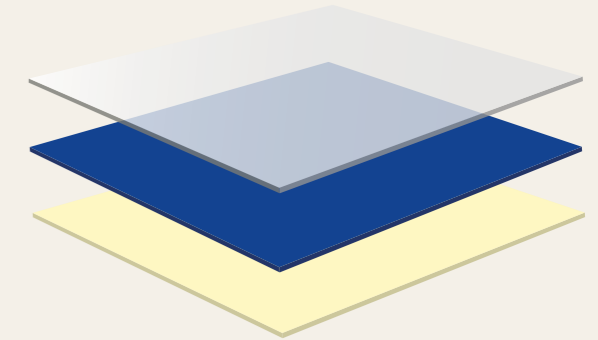



LOGLIFE FLOOR MARKING 600 MM

600 mm



Prohibited for industrial trucks

Order no.
LG-SCHILD-600-1



Prohibited for pedestrians

Order no.
LG-SCHILD-600-2



No smoking

Order no.
LG-SCHILD-600-8



Step speed

Order no.
LG-SCHILD-600-14



No access for unauthorised persons

Order no.
LG-SCHILD-600-17



No stopping

Order no.
LG-SCHILD-600-16

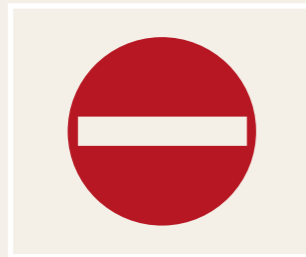

Prohibition of entry

Order no.
LG-SCHILD-600-11



Stop and give way!

Order no.
LG-SCHILD-600-9



Use foot protection

Order no.
LG-SCHILD-600-5



Use eye protection

Order no.
LG-SCHILD-600-6



Use head protection

Order no.
LG-SCHILD-600-7



For pedestrians

Order no.
LG-SCHILD-600-4



Direction indicator (arrow)

Order no.
LG-SCHILD-600-10



Wear a high visibility vest

Order no.
LG-SCHILD-600-12



Wear hearing protection

Order no.
LG-SCHILD-600-13



Warning of industrial trucks

Order no.
LG-SCHILD-600-3



Warning Danger of slipping

Order no.
LG-SCHILD-600-15

600 mm

At orgatex.com you will find all ASR A1.3 (DIN EN ISO 7010) mandatory and prohibition signs you need for standard-compliant labelling in your company.

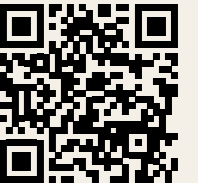



HALF AND QUARTER CIRCLES 900 MM

900 x 450mm



Order no.
LG-SCHILD1/2-1



Order no.
LG-SCHILD1/2-2



Order no.
LG-SCHILD1/2-3



Order no.
LG-SCHILD1/2-4

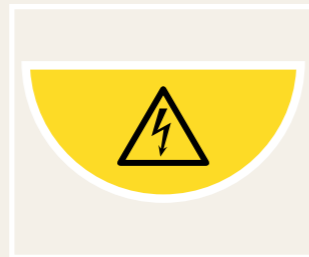

Order no.
LG-SCHILD1/2-7

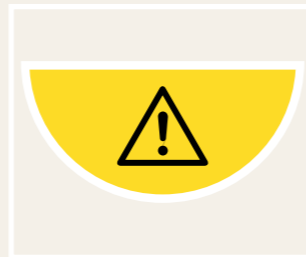

Order no.
LG-SCHILD1/2-8



Order no.
LG-SCHILD1/2-9



Order no.
LG-SCHILD1/2-10



Order no.
LG-SCHILD1/2-11



Order no.
LG-SCHILD1/2-6

900 x 900 mm



Order no.
LG-SCHILD1/4-1



Order no.
LG-SCHILD1/4-2



Order no.
LG-SCHILD1/4-3



Order no.
LG-SCHILD1/4-4



Order no.
LG-SCHILD1/4-5



Order no.
LG-SCHILD1/4-6



Order no.
LG-SCHILD1/4-7



Order no.
LG-SCHILD1/4-8

At orgatex.com you will find all ASR A1.3 (DIN EN ISO 7010) mandatory and prohibition signs you need for standard-compliant labelling in your company.





LOGLIFE CROSSWALK

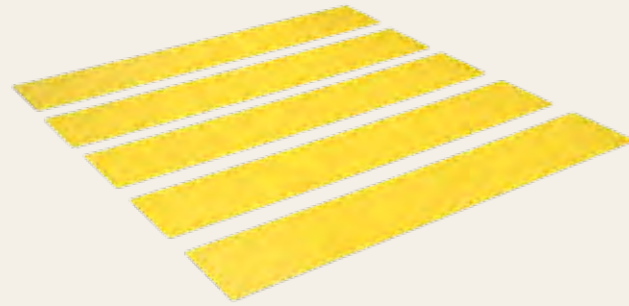

Our high-quality, self-adhesive zebra crossing has been specially developed for industrial use. With its outstanding quality and exceptional durability, it offers a reliable solution for safe pedestrian crossings in demanding environments. Trust in a product that meets the highest standards and significantly improves safety in your work environment.

- High warning and information effect
- High durability
- Suitable for smooth, gap-free floors indoors
- Flexible design due to individual strips



LongLife crosswalk

Item number	Format (mm)	+ Colour code	Number of strips
LGZS120-	200 x 1200	04	1
LGZS150-	300 x 1500	04	1
LGZS120-	200 x 1200	02	1
LGZS150-	300 x 1500	02	1

Installation suggestion:

5 strips are sufficient for a complete zebra crossing. Please note the width of your aisle.



INDIVIDUAL PRINTING



Information we need:

- File or graphic of the sign (AI, CDR, EPS, JPEG)
- Colour definition or RAL tone
- Size of the sign
- Material (e.g. foil, plastic, aluminium)
- Purchase quantity

ORGATEX® process:

01
Enquiry

02
Offer

03
Layout release

04
Order

05
Production

06
Delivery

Please contact our service team.

E-Mail: sales@orgatex.de
Phone: +49 2173 1064-0



WARNING MARKINGS

Make it easier for your employees to find their way around the workplace and prevent contact with areas of danger. ASR A1.3 requires clear and permanent markings to be used to identify obstacles and danger areas. The markings should be either yellow and black or red and white and selected according to the size of the obstacles or danger points.

Applications for yellow and black markings are places where there is a risk of collision, entrapment, falling, slipping, tripping or falling loads.

Red and white markings, on the other hand, are recommended for temporary or movable obstacles and danger areas, such as crane hooks, construction pits, ladders, etc.

What does the directional indication „left“ or „right“ actually mean? Markings that point to the left or right are used to guide the observer past the obstacle or hazard on the left or right.

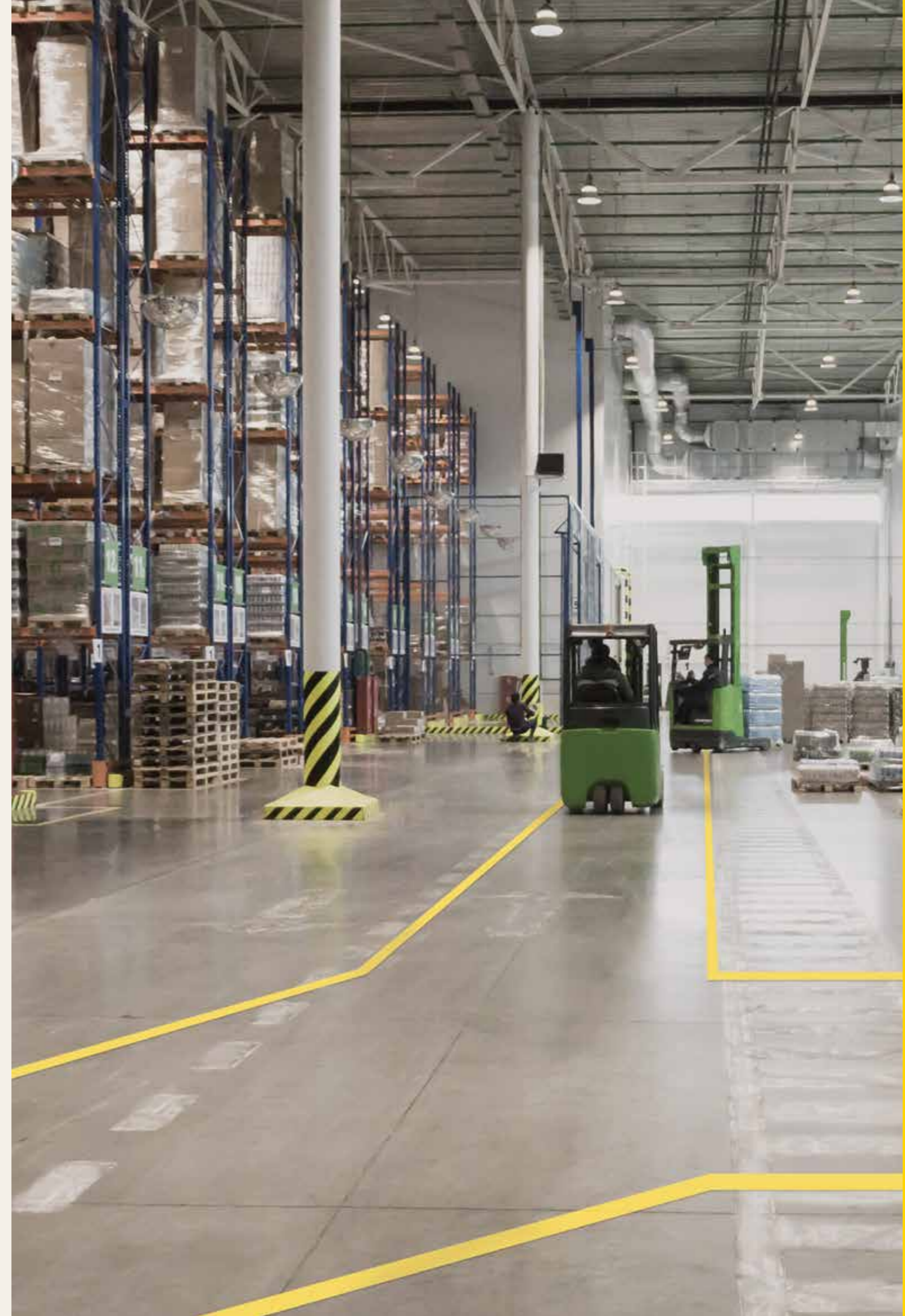



LONGLIFE FABRIC TAPE

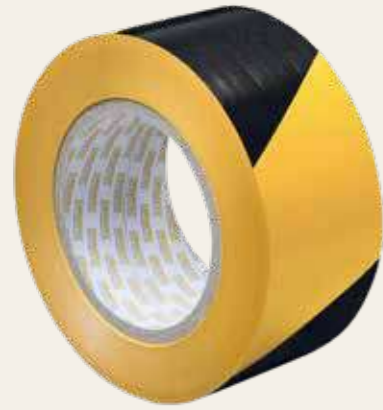

Unlimited application possibilities! The LongLife fabric tape is a PE-coated, dense, fine-threaded and waterproof synthetic silk fabric with a highly adhesive, shear-resistant natural rubber adhesive with very good durability. It is ideal for connecting, fastening, bundling, repairing and sealing. It is also available in a wide range of colours and is perfect for industrial identification and as a quick, eye-catching way of marking danger spots. It can be used both indoors and outdoors.

- Very good durability
- For indoor and outdoor areas
- Resistance to abrasion, decomposition and moisture
- Firm texture
- Dense, fine-threaded and water-proof synthetic silk fabric tape

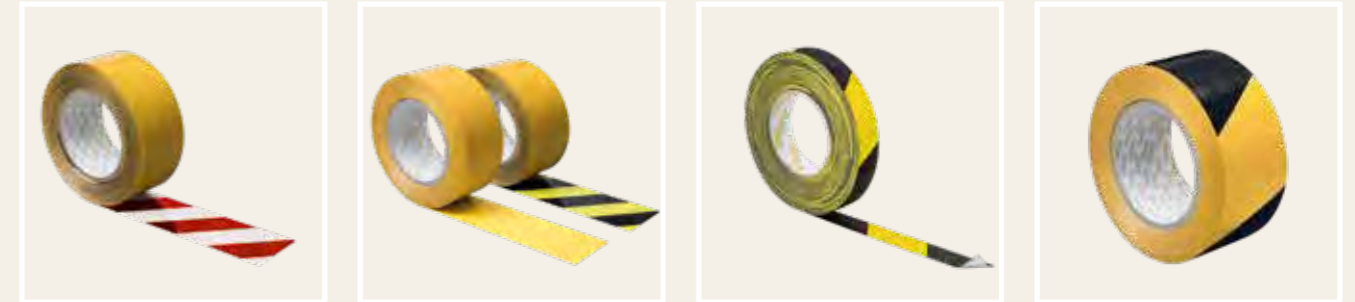

LongLife Fabric tape

Version	Width (mm)	Order no.	+ Colour code								Points
Points	30	LGGW30-P-	01	02	-	04	05	06	07	88	4000

LongLife Fabric tape

Version	Width (mm)	Order no.	Colour code						Roll length (m)	
Floor Marking Tape	50	LGGW50-						SGL	SGR	50
Floor Marking Tape	75	LGGW75-						SGL	SGR	50
Floor Marking Tape	100	LGGW100-						SGL	SGR	50

LongLife Floor Marking Tape

Version	Width (mm)	Order no.	Colour code					Roll length (m)	
Floor Marking Tape	50	LG50-	SG	BW	GW	RW	SW		50
Floor Marking Tape	75	LG75-	SG	BW	GW	RW	SW		50
Floor Marking Tape	100	LG100-	SG						50

LongLife Floor Marking Tape Low Duty

Version	Width (mm)	Order no.	Colour code				Roll length/ Pack (m)	
Floor Marking Tape	50	LGLD50-	SG			RW		3 x 33
Floor Marking Tape	75	LGLD75-	SG			RW		2 x 33

LongLife Floor Marking Tape Grip

Version	Width (mm)	Order no.	Colour code						Roll length (m)	
Floor Marking Tape	50	LGG RIP50-	SG						25	
Floor Marking Tape	75	LGG RIP75-	SG						25	
Floor Marking Tape	100	LGG RIP100-	SG						25	

You can find more anti-slip tapes on the corresponding pages.



DIGITAL INTRA LOGIS TICS

Of course, you already know that digitisation is the key to an efficient shop floor. But did you also know that digitisation is quick and easy with ORGATEX®? Without cables, without complicated IT infrastructure, but with lots of powerful features for greater efficiency? Introducing: eOX.

[katalog.orgatex.com/
digitale-intralogistik](https://katalog.orgatex.com/digitale-intralogistik)

eOX-Mobile Shopfloor Board	346
eOX-Label	348
eOX-Button	350
eOX-Energy-Control	352
eOX-Spot	354
eOX-Spot-standard motifs, 40 W and 80 W	356
eOX-Station	358
eOX-Monomover	360

Get started immediately due to mobile communication

Having to set up a complex and costly IT infrastructure with gateways, routers and separate networks before you can digitise – we don't find that efficient, we think it's unnecessary. That's why our eOX solutions work with secure and affordable narrowband mobile technology. For you, this means that you can attach components such as the eOX button or the eOX label anywhere and then automatically transfer data to your smart ecosystem at the touch of a button.

360° digital, all-round efficiency

Whether it is digital and dynamic labelling of goods and materials or automated processes at the touch of a button, Constant process clarity for everyone due to

real-time data or smart outgoing goods – with eOX, you can digitalise processes in your intralogistics from start to finish and are therefore simply more efficient.

Simple control, triple security: the eOX cloud

The eOX cloud is your digital control centre that you can use to set up your eOX devices, plan automated processes and always keep track of your process data. We have taken care to make operation so simple and intuitive that you can set up almost everything without having to consult your IT department. And thanks to SSL/TLS encryption, your data is excellently protected.



eOX-MOBILE SHOPFLOOR BOARD

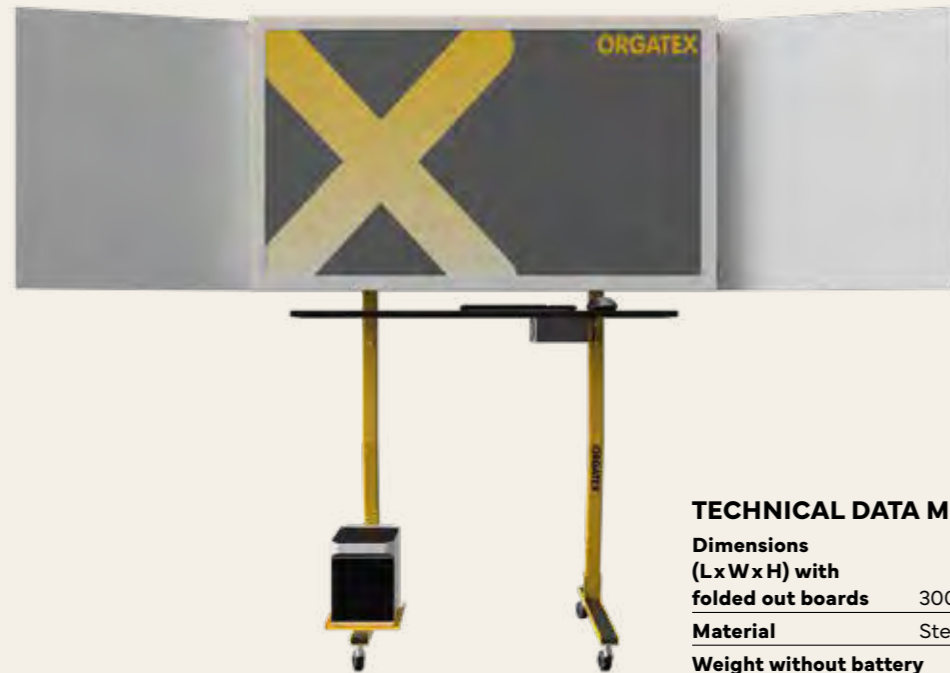

TECHNICAL DATA MOBILE SHOPFLOOR BOARD

Dimensions (L x W x H) with folded out boards	3000 x 800 x 1950 mm
Material	Steel (powder coated)
Weight without battery and Samsung Flipp	Approx. 81 kg

TECHNICAL DATA BATTERY MOBILE SHOPFLOOR BOARD

Net weight	Approx. 12 kg
Dimensions (W x H x D)	400 x 211 x 281 mm
Capacity	1024 Wh, 51,2 V
Optimal operating temperature	20 °C bis 30 °C
Service life	3000 cycles up to 80 % capacity
AC input Voltage	220 – 240 V ~ 10 A, 50/60 Hz
Cell chemistry	LFP

TECHNICAL DATA SAMSUNG FLIP MOBILE SHOPFLOOR BOARD

Net weight	40 kg
Dimensions (W x H x D)	1522 x 898 x 63 mm
Screen diagonal	1.638 mm (65")
Energy consumption	100 W
Operating temperature	0 °C bis ~ 40 °C
Touch response time	6,7 ms
Screen resolution	3840 x 2160 Pixels

Discover the numerous advantages of our digital shop floor management tools. With the eOX boards, you can digitally map all your key figures, protocols and CIP measures while you carry out your production or departmental reviews.

They accelerate your information flows and make changes transparent. The eOX boards can be customised according to your templates. On request, we can offer you variants for every specific application: production meeting board, OEE board, machine board, topic memory.

Real-time data where it is needed

The Mobile Shopfloor Board offers a whiteboard surface, a touchscreen monitor and an independent power supply. It can therefore be used flexibly and on the move at any time. With the Mobile Shopfloor Board, your shift meetings can take place directly on site. The key figures and information are therefore always where the problems were observed. The Gemba principle means that every employee can understand, analyse, and resolve the causes of problems. This increases motivation in your company exponentially! The Mobile Shopfloor Board is available with or without a battery.

eOX-Mobile Shopfloor Board	
Version	Order no.
Mobile board with battery	EOX-MSB
Mobile board with battery	EOX-MSBL

DIGITAL SHOPFLOOR MANAGEMENT WITH THE NEW APEXBOARD



Available from February 2024 for just €149 per month.

PRE-ORDER NOW!

Please contact us:
+49 2173 1064-0 | apexboard.io

YOUR BENEFITS WITH A DIGITAL SHOPFLOOR SOLUTION:

- Trustworthy, traceable data for operational key figures
- Simple control and tracking of measures and the development of standards
- Centralised data maintenance, data storage and data archiving through to automated transfer from upstream systems
- Clear presentation due to customisable dashboards
- Automated deviation calculation for a faster response
- Efficient communication in a centralised system that is comprehensible for all parties involved
- Simplified integration of employees and managers through clear task and target assignments
- Seamless integration of external digital systems for extended communication support

Functions of Apexboard:		
Provide key figures in aggregated and detailed standard reports according to SQCDP for a quick overview in regular meetings	Create individual key figures and process transaction data manually or automatically*	Create problem-related measures, edit, track and structure to establish new standards
Assign measures to individual persons and management levels. If required, external notification channels such as email, MS Teams or Slack can be integrated*.	Adaptation of the structure and menu to departmental used for structured communication.	Historization of key figures in the Peakboard Hub online. If required, the data can later be analysed with tools such as Microsoft Power BI, Tableau**

TECHNICAL DATA PEAKBOARD-BOX



Inkl. Peakboard-Box

Processor	Intel 8th Gen Celeron Processor N4100	CPU	Base clock frequency: 4 x 1.10 GHz / Burst clock frequency: 2.40 GHz
RAM	4 GB LPDDR4, 2400 MHz	in/Outputs	2 x USB 3.0, Type-A / 1 x USB, Type-C (PD, DP, USB 3.0) / 1 x HDMI, RJ45
LAN	10/100 baset ethernet	Other	Template library, Self-service knowledge database, up to 100 different data sources
Network (AC)	10/100/1000Mbit Ethernet / WIFI 802.11		
Rated power	45 W		
OS	Windows 10 IoT Enterprise		

*This function may require customisation, which you can carry out yourself using the free Peakboard Designer. Otherwise, it is possible to order additional customisations directly from Peakboard for a fee.
**External applications that are not included in the offer.



eOX-LABEL



TECHNICAL DATA EOX-LABEL

Item number	eOX-Label
Display technology	E-Ink
Display size	Standard 5,83"
Dimensions (H x B x T)	160 x 116 x 17 mm
Display layout	Customisable
Radio technology	Narrowband IoT
Protocol	MQTT-SN
Button	Freely assignable functions
Information source	eOX-Cloud or ERP-System
Data retrieval	Button press, time interval or system trigger



Digital labelling made easy

The eOX label is the perfect solution for efficient and environmentally friendly labelling in intralogistics and production. Due to our innovative and reusable digital label, you not only save time, but also valuable resources. By using the eOX-Label, there is no need to create and replace paper labels, instead you have the option of displaying all information digitally and in real time on the modern e-ink display.

Digital intralogistics not only saves time in production, but also protects the environment. Our e-labels connect via the NB-IoT mobile network using the MQTT-SN protocol and are therefore independent of any other infrastructure. The e-ink displays combine the advantages of analogue media, such as scanability

and readability from all angles, with those of digital media, such as fast content exchange and reduced effort with minimal energy consumption.

With the eOX label, you can optimise your intralogistics and production processes. It is the perfect solution to save time and resources while offering an environmentally friendly alternative to paper labels. Invest in the eOX-Label to get a professional and flexible labelling solution that is tailored to your individual needs.

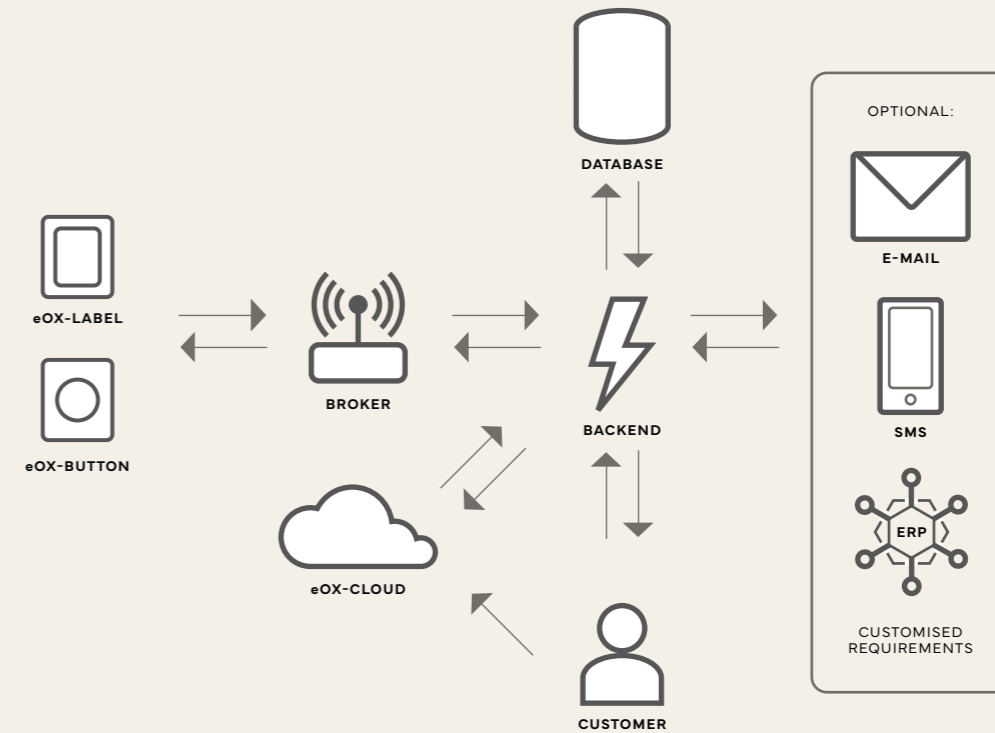

1. Broker

The broker is used for secure and encrypted communication with the eOX label via MQTT-SN

2. Backend

The messages are analysed in the backend and forwarded to the correct recipient.

3. Database

The status of the label and the configuration are stored in the database. These are updated with every interaction.

4. eOX-Cloud

The interface is an API that is made available to the customer. The customer can use commands to operate the eOX label. This allows the status and metadata of the label to be called up and updated directly. Each customer can customise their labels and view usage data via the configuration website.

5. Optionale Module

Depending on the application, optional modules can be added, such as automated e-mail dispatch.



eOX-BUTTON

MORE EFFICIENCY. AT THE TOUCH OF A BUTTON.



The eOX button is the easy way to digitally automate your operating, logistics or production processes. Due to its narrowband wireless technology and battery operation, you can install the eOX button anywhere in just a few simple steps. And with the help of the intuitive operation in the eOX cloud, even non-IT experts can create complex automations. For these applications, for example:

Finished part notification at the touch of a button

With the eOX button, it only takes the push of a button for a finished product to be picked up by the AGV or forklift truck driver. At the same time, you keep the data in your ERP or WMS system always up to date with an automatic finished part notification.

Automated material procurement

Always the right amount of raw material in the warehouse – the eOX button makes this easy and automatic. If material is running out, your warehouse staff simply send an automatic procurement order to the purchasing department at the touch of a button. At the same time, the stocks in your WMS or ERP system are updated. This allows you to shorten replenishment times, reduce staff retention and make reliable procurement decisions.

Faster error messages

With the eOX button, you can reduce production interruptions through automated error messages. One press of a button is all it takes to inform relevant parties, such as a foreman, about machine faults and request help at the same time. The message can also be sent to your OEE or MES system and visualised on Andon boards, for example.

Simple parts request

If your product consists of several components, the eOX button reliably helps you to avoid expensive downtimes. As with material procurement, production employees simply request the required parts at the touch of a button as soon as a minimum quantity is not reached.

TECHNICAL DATA eOX-BUTTON

Item number	eOX-Button
Supply Voltage	2,5 V – 12 V
Processor	ARM Cortex M3
Device dimensions (L x W x H)	72 x 53 x 26 mm
Display size	1,54 Inch, 200 x 200 Pixels
HMI-Refresh-Rate	Partial: 0.3 s, full: 2 s
Antenna (internal)	NB-IoT B8/B20
Weight incl. battery	81 g
Battery	2 x AA
Radio	NB-IoT
Programming	UART
Storage	NB-IoT
SIM	Nano-SIM (4FF)
HMI	E-Paper-Display

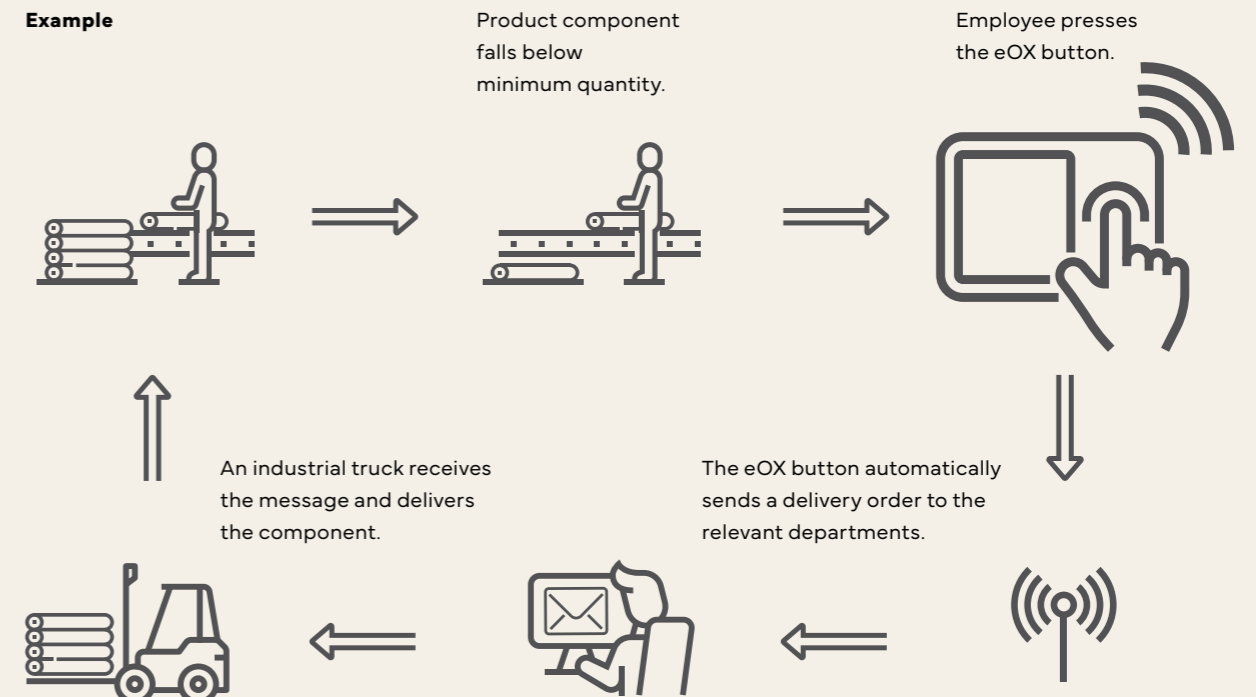



eOX-ENERGY-CONTROL



Saving energy intelligently

With eOX-Energy-Control, you have full control over your energy consumption and can therefore make effective savings.

The smart socket allows you to individually control the consumption of your electronic devices and easily identify or switch off consumers that are not required. Thanks to the web-based user interface, all connected eOX Energy Control devices can be controlled together or separately.

In addition to the option of individual control, eOX-Energy-Control also offers the option of analysing the operating status of individual systems. Changes in power consumption signal operating faults even before they lead to a standstill. This allows you to better plan upcoming maintenance and carry it out before the machine breaks down.

eOX-Energy-Control offers you a professional solution for increasing your energy efficiency and optimising your work processes.

TECHNICAL DATA eOX-ENERGY-CONTROL

Item number	eOX-Energy-Control
Measuring interval	1 s (configurable)
Transmission interval	1 min (configurable)
Input/output voltage	230 V AC ± 10 %
Frequency	50 Hz
Max. supported power	12 A / 2760 W
Plug / consumption in operation	Schuko (2W)
Operating temperature	-10 °C to +45 °C
Radio	NB-IoT
Protocol	TCP / IP und SSL
Programming	ST-Link
Troubleshooting	UART
Controller (processor)	ARM Cortex M4
SIM	NANO-SIM (4FF)
Antenna (internal)	NB-IoT, Band 20
Max. High-frequency power transmission	21 dBm

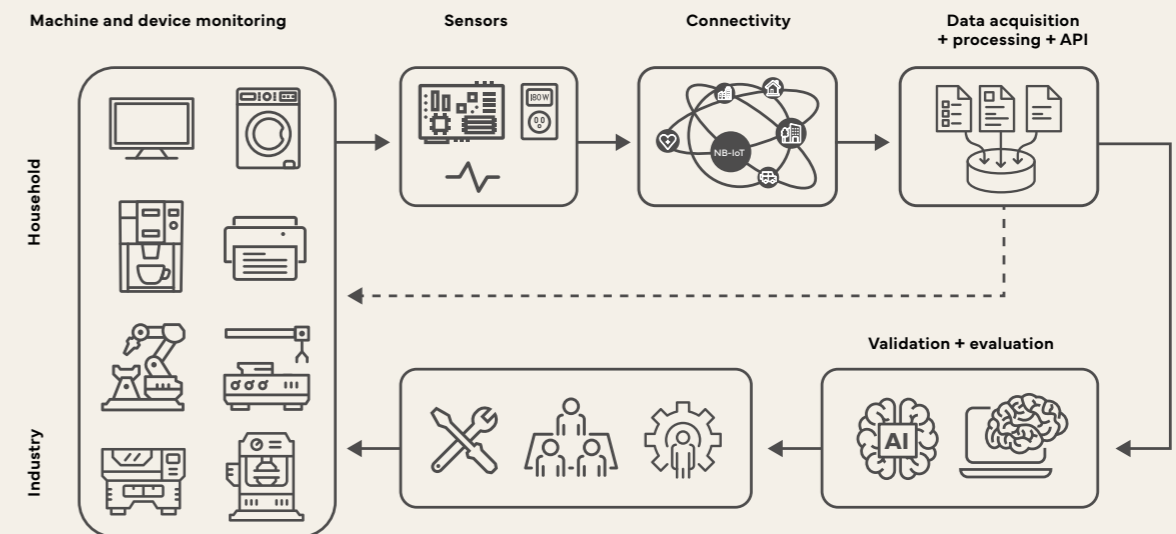



eOX-SPOT



Modern LED tool for a safe working environment

Stop dangerous situations with the light projector for warning signals: The eOX spotlight with integrated power supply unit can not only be fitted with standard safety and warning signal LEDs, it can also be used in a variety of ways with customised motifs. Regardless of the nature of the ground, the swivelling projector with an efficiency of 27 or 56 lm/W projects the required sign onto the desired spot. This avoids hazards such as tripping or abrasion.

Renew your marketing activities!

In addition to its function as an indispensable security tool, you can also use the powerful projector (40 or 80 W) for eye-catching marketing. Your company logo, for example, will be a real eye-catcher!

Advantages at a glance:

- Simple assembly
- High-power LED with 40 W / 80 W
- Easily interchangeable motifs
- Versatile use
- Integrated power supply unit for 230 V
- High energy efficiency
- No wear and tear

TECHNICAL DATA eOX-SPOT

Item number	eOX-Spot-40 eOX-Spot-80
Housing material	Steel/aluminium, powder-coated
Weight	1,97 kg 3,5 kg
IEC socket	On the back of the device
Application area	Dry indoor areas
Ambient temperature	-30 °C to +35 °C
Cooling	Active cooling/fan
Noise level	20 dB(A) 29 dB(A)
Light source	40-W- 80-W-High-Power-LED
Average LED service life	35.000 hours
Colour temperature	6300 – 6700 K
Luminous flux of the projector	1.150 lm 4.730 lm
Efficiency	27 lm/W 56 lm/W
Motif size/image size	37,5 mm / 20 mm 50 mm / 40 mm
Input voltage	220 – 240 V AC, 50/60 Hz
Power consumption	42 W 84 W
Protection class/ Enclosure protection class	I/IP20
Photobiological safety	RG-2 (acc. to ICE62471-5:2015, EN62471-5:2015)

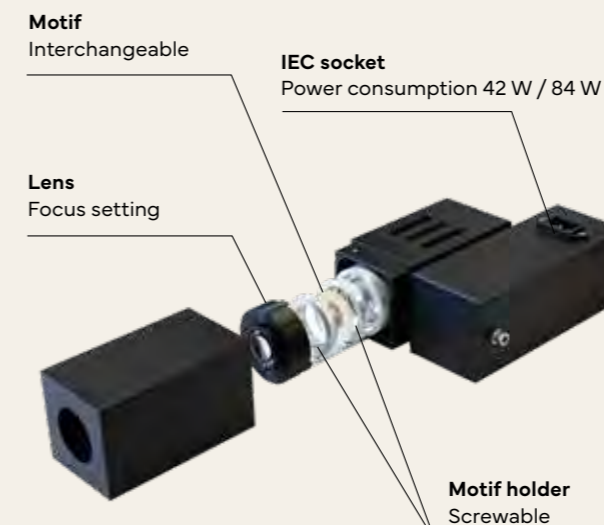



eOX-SPOT-STANDARD MOTIFS 40 W AND 80 W



Prohibited for industrial trucks

Order no.
EOX-SPOT-M-1
EOX-SPOT-80-M-1



Prohibited for pedestrians

Order no.
EOX-SPOT-M-2
EOX-SPOT-80-M-2



Warning of industrial trucks

Order no.
EOX-SPOT-M-3
EOX-SPOT-80-M-3



For pedestrians

Order no.
EOX-SPOT-M-4
EOX-SPOT-80-M-4



Stop and give way!

Order no.
EOX-SPOT-M-9
EOX-SPOT-80-M-9



No access for unauthorised persons

Order no.
EOX-SPOT-M-17
EOX-SPOT-80-M-17



Warning of industrial trucks

Order no.
EOX-SPOT-M-101
EOX-SPOT-80-M-101



Forklift traffic, no entry, pedestrians and much more: warning and information signs are regularly required in the manufacturing industry and many other sectors. You will find ready-made motifs for standard situations in our range. Customised motifs are also possible.

eOX-SPOT-STANDARD MOTIFS 40 W AND 80 W



Black & White (Motif without colour)

Order no.
EOX-SPOT-MI-SW
EOX-SPOT-80-MI-SW



1 Colour (Motif single-colour)

Order no.
EOX-SPOT-MI-1
EOX-SPOT-80-MI-1



2 Colours (Motif two-colours)

Order no.
EOX-SPOT-MI-2
EOX-SPOT-80-MI-2



3 Colours (Motif three-colours)

Order no.
EOX-SPOT-MI-3
EOX-SPOT-80-MI-3



4 Colours (Motif four-colour)

Order no.
EOX-SPOT-MI-4
EOX-SPOT-80-MI-4

eOX SPOT 40
Illuminance [lux]

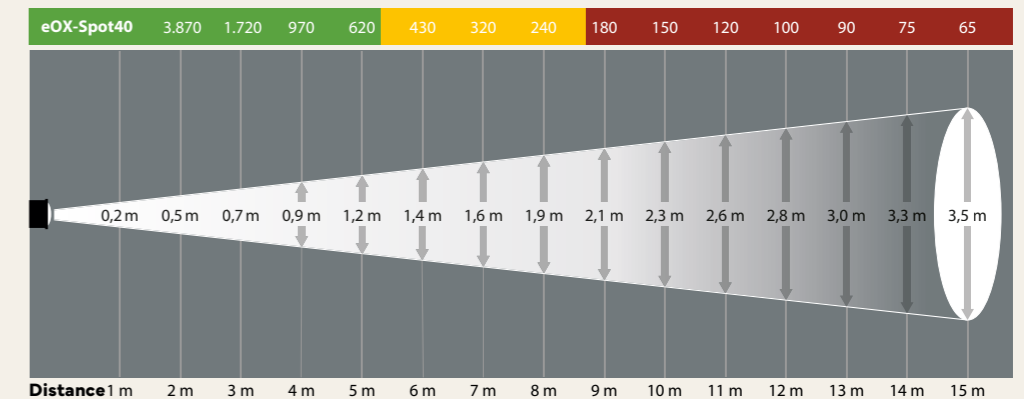

eOX-SPOT 80
Illuminance [lux]

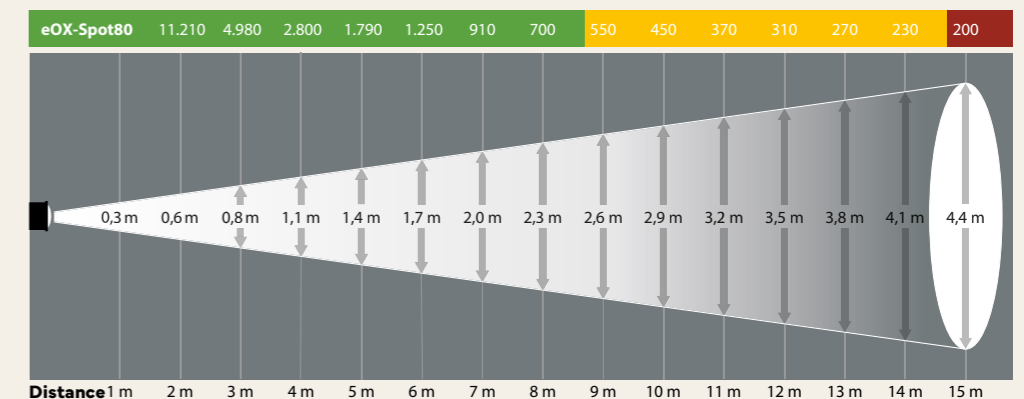



eOX-STATION



How to configure your FiFo tracks digitally

The eOX station is the digital extension to our classic FiFo station. Connect up to 120 lanes with an efficient pick-by-light system.

Missing withdrawals are minimised, internal and external subsequent delivery processes are automatically triggered according to the KANBAN principle and the digital interface enables direct access to all goods movements.

- Classic FiFo station, digitally enhanced
- Up to 120 tracks can be linked together
- Sensors register floor rollers when retracting and extending
- High level of safety: system operates with 24 V DC (direct current)

TECHNICAL DATA eOX-STATION

Item number	eOX-Station
Supply voltage	24 V (direct current)
Sensors	Magnetic Hall Sensors
Maximum number of tracks	120
Recognisable transport container	Dollies (more on request)
Housing material	PA12 (additively manufactured)
Necessary infrastructure	Schuko socket
Internal data transfer protocol	MODBUS RTU
Response time	< 1 s
Optional cloud connection	Via LTE
Retrievability of the data	REST API





eOX-MONOMOVER

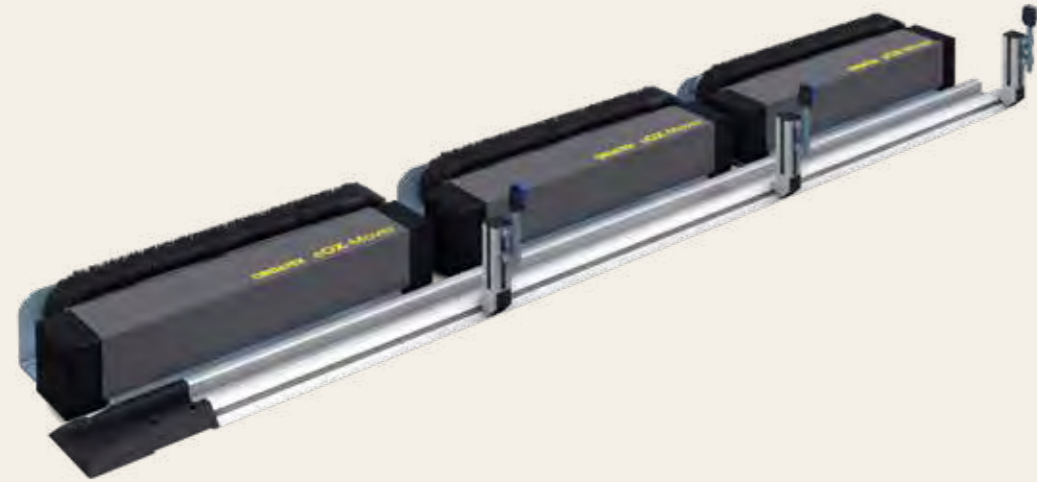

More efficiency for your FiFo station:

The eOX monomover is a further automation system for FiFo railway stations. The feed unit becomes the centrepiece of modern intralogistics: the eOX-Monomover transports dollies (total load up to 180 kg) independently from A to B via bristle belts. In this way, FiFo stations can be upgraded, and production processes optimised. Light barriers at the end of each unit automatically control the transport from one module to the next.

- Light barriers at the module ends
- Synthetic leather belt brush strap
- Unlimited track length

TECHNICAL DATA EOX-MONOMOVER

Item number	eOX-Monomover
Size per unit (L x W x H)	535 x 210 x 140 mm
Size of switch cabinet	Depends on power and size of unit
Feed speed	3 m/min
Power data	50 W/24 V DC (direct current) / 2 A
Input voltage	220 – 240 V AC, 50/60 Hz
Max. Total load	Up to 180 kg
Structural requirements	Level, clean hall floor with at least 20 N/mm ² compressive strength (concrete strength class C20/25 to C50/60; non-cracked)
Other	Distance to moving parts must be \geq 120 mm. Compatible with ORGATEX® FiFo monorail tracks.

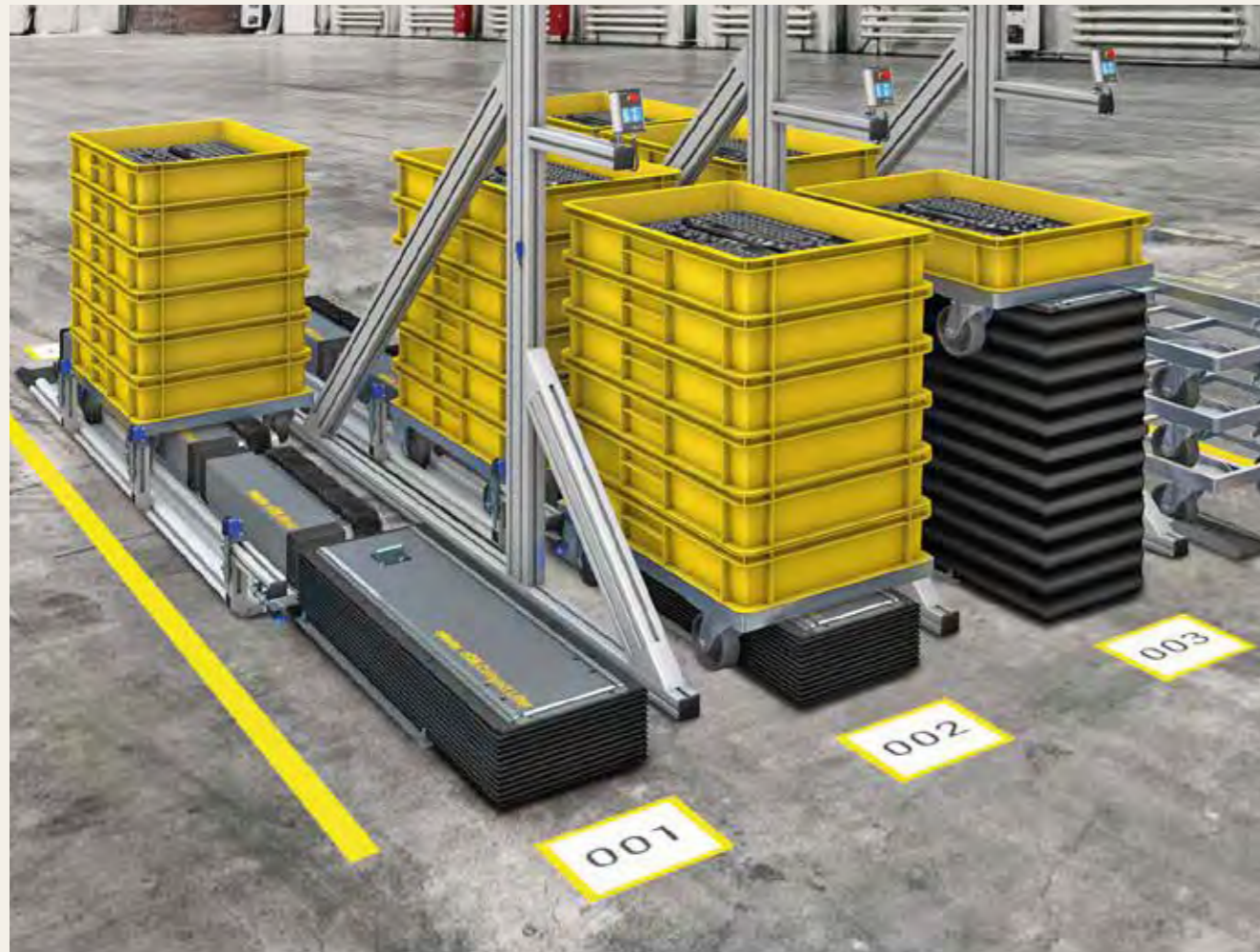



OUR RANGE OF SERVICES

We want every company to be a lean business. That's why we not only offer over 3,000 products for more efficiency, but also support you with valuable services ranging from bonding services to lean seminars to help you find your own individual way.



A lean business needs two things: a suitable and functioning infrastructure for lean processes and in-depth knowledge of effective methods. We are happy to support you with both of these with our combined experience of over 50 years.

With our bonding service, lean corner service and FiFo station service, we ensure that your lean infrastructure is perfectly assembled and ready to use in a short space of time. You also save your resources because your employees are not tied up with bonding work.

And in our lean seminars and ORGATEX® roadshows, our experienced speakers will give you in-depth insights into lean methods and bring you up to date with the latest developments in lean management.

Our services:

- **Bonding service** → S. 364
- **On-site assembly of FiFo stations** → S. 366
- **Lean-Corner-service** → S. 368
- **Lean-Seminars** → S. 370
- **Roadshows** → S. 371

BONDING SERVICE



There are walkways, danger zones, storage areas and much more in every shop floor and production hall. Precise marking makes work easier, minimises human error and contributes significantly to compliance with regulations. Our product line sets the standard for these markings.

The quality of the bonding and the materials used play a decisive role in the durability and visibility of the marking. This is where our specialised on-site bonding service comes in. We consult you individually, create a customised marking plan and guarantee optimum adhesion thanks to our specialist knowledge. Depending on the nature of the surface, strains and industry conditions, our experts will identify potential danger spots, define routes and install the optimum marking system.



The materials used by ORGATEX® are of the highest quality. They are forklift-proof, have high abrasion resistance, are characterised by excellent adhesive strength and have been specially developed for block storage or other heavy-duty areas. Our professionals know the ideal processing temperature and their experience guarantees perfect bonding. In addition, we are familiar with the relevant legal regulations and normative specifications, such as the accident prevention regulations in accordance with BGV A8, the Workplace Ordinance (ArbStättV) § 3 (1) and the M11 leaflet for internal traffic routes from the trade association and implement these.

Our service not only offers visual advantages, but also makes day-to-day work easier due to clear structures and guidelines. The number of accidents is reduced, responsibilities and work areas are visualised, and processing times are shortened. Professional hall labelling has a positive effect on your employees. An organised, structured environment not only increases work efficiency, but also the general well-being and satisfaction of your team.

We are committed to providing you with the best possible service and pride ourselves on our high standard of installation and service. Let's work together to make your working environment safer, more efficient and clearer and advance your operational excellence.

Individual Consulting

In modern intralogistics, floor markings ensure safety and efficient processes. Specific shapes as well as colour and reflective properties indicate potential danger points, draw attention and structure to the material flow.

Floor markings play a central role, particularly in modern manufacturing and operating strategies such as the 5S system, the Andon system, and the classic Toyota Production System (TPS). It standardises work areas, marks walkways and ensures that everything is in its place.

Customised Marking plans

This not only increases productivity and ensures reliable processes, but also maximises efficiency.

We are constantly developing our labelling materials to meet the various industry requirements. From hard-wearing floor windows and heavy-duty tapes or labelling modules for indoor and outdoor use to applications such as cold stores with ambient temperatures of up to -20 °C, ORGATEX® offers the right solution for every situation.

Optimal Bonding



**Save time and nerves.
You can rely on
fast assembly and our
On-site-bonding service.**

Contact us by phone or online.

+49 2173 1064-0

To the contact form



ON-SITE ASSEMBLY OF FIFO STATIONS



Longstanding Expertise

The increasing complexity of intralogistics, the growing diversity of production and the trend towards „instant delivery“ require robust and modern solutions. A FiFo station or supermarket makes fill levels visible and enables clear material allocation during filling or removal. This allows the required production quantity to be pre-picked and the goods to be replenished with pinpoint accuracy. A FiFo station system combines the advantages of visual warehouse management with the operability of a parking system.

Precise assembly without drilling

Our experienced teams assemble your FiFo station on site and ensure customised integration into your production environment. Thanks to our in-depth expertise and experience in various industries, we guarantee precise installation and fast completion. The ORGATEX® monorail rail system, for example, has a modular design and can be installed without drilling. We customise the length and width to your individual requirements. The end caps serve as collision protection and the flat sides and coloured covers provide additional protection against accidents at work caused by tripping.

On-site Consulting

Because every detail is important for perfect function, our experts will accompany you from planning to installation.

As instructions must be immediately visible and intuitively positioned on a busy shop floor, we recommend labelling directly on the system. The combination of floor labelling and labelling of the enclosures makes it easier for the commission agent to allocate items immediately and prevents misplacement. In this way, a rail system becomes a holistic solution that increases the efficiency of your operation.

In over 50 years of planning, manufacturing and assembling intralogistics systems, we have had the unique opportunity to familiarise ourselves with a wide range of industries. We value dialogue at eye level and cooperation based on partnership. We know that things have to happen quickly and yet no detail should be forgotten. We know the guidelines for working in cleanrooms, the high safety standards in the food industry and the priority of occupational safety. Our aim is to understand and fulfil the requirements and needs of our customers. Our team of experts is ready to turn your individual challenges into efficient solutions.

From the very first consultation, our focus is on improving the operational process organisation. It must be agile, suitable for everyday use and intuitive so that you are well positioned for the future.

With our team of experts operating throughout Germany, we can advise you on site and support you with an efficient, holistic solution based on your day-to-day operations for ideal material provision.



For questions or a non-binding offer, please contact our service team will be happy to help you at any time.

Contact us by phone or online.

+49 2173 1064-0

To the contact form



LEAN CORNER SERVICE



Properly planned and installed, lean corners produce amazing results.

Versatile Solutions

The Lean Corner is the starting point for a daily scrum or morning meeting, a central location for the presentation of key figures and the basis for effective team communication. This makes it an essential part of a modern, lean production environment and has a major impact on the efficiency of the shop floor, the daily lives of employees and successful operations.

Customised Planning

The composition of a Lean Corner is based on the requirements of your shop floor and your daily work. Numerous options and different designs make it an effective visual management tool. Whether wall-mounted, digital or analogue, mobile, magnetic or stationary: a Lean Corner is a customised solution that structures your shop floor and fits seamlessly into your working environment.

Process optimisation

Our service includes the planning and installation of your customised Lean Corner.

We rely on state-of-the-art technology that not only enables the integration of digital data, but also fulfils the requirements of Industry 4.0. A special aspect of our Lean Corners is the integration of modern IoT devices and data analysis tools. This enables real-time monitoring and provides an innovative platform for optimising workflows.

Our Lean Corners are particularly characterised by the integration of CIP boards, which stand for „Continuous Improvement Process“. This is a central management method that uses the expertise and experience of employees to continuously optimise work processes. This principle ties in seamlessly with the Muda concept, which aims to identify and reduce any kind of waste – be it physical resources, time, energy or unutilised potential. The focus here is on sustainability. In view of global challenges and limited resources, it is essential to act in a sustainable, responsible and future-orientated manner.

Our Lean Corners are particularly versatile thanks to their modular design. From inscribable surfaces to magnetic walls that allow the attachment of accessories such as KPI indicators and magnetic frames, we offer a wide range of customisable options.

The in-house installation of Lean Corners in a company goes beyond the mere physical creation of a new workspace. It is the first step towards a transparent, efficient and productive working environment. When we look to the future, we see an even more connected and digitalised working world. Our Lean Corners are constantly evolving to meet these requirements and to accompany you on your journey into this future.



**Take the first step
towards your Lean Corner.**

Contact us by phone or online.

+49 2173 1064-0

To the contact form



LEAN SEMINARS



Benefit from the concentrated lean knowledge of our experienced speakers.

We are happy to pass on our knowledge of efficiency and lean methods, which we have gathered over more than 50 years. In intensive lean seminars, our experts impart extensive knowledge on lean management, shop floor optimisation and more. You will gain valuable insights and learn proven methods for greater efficiency in your company.

Our specialised intensive workshops:

- Lean management / shop floor management
- Intensive workshop OEE/TPM
- Intensive workshop 5S/equipment
- Intensive workshop on material flow/workplace design
- Intensive workshop lean in administration

Are you interested in the next seminar dates?

For further details on our seminars, please contact us by phone or online.

+49 2173 1064-0

To the contact form



ROADSHOWS



Learn how to optimise processes in both theory and practice.

Since 2004, the Lean Factory Group has been offering technical solutions for process optimisation and maximum competitiveness. The focus is on theory and practice – our concept includes the 3 building blocks of hardware, software and expertise. Do you want to reduce costs and realise maximum efficiency?

Our team knows the latest trends and updates, which we share with you during the roadshows. How can employees recognise waste and find a solution to the weak spot(s) themselves? Our workshops provide effective know-how to eliminate unnecessary steps in the company and improve workplace organisation.

Would you like to deepen your expertise with our roadshow?

For further details on our Lean Factory seminars, please contact us by phone or online.

+49 2173 1064-0

lean-factory.com



INDEX

2SDSK/1310-	36	ET33-75K-	83	HE167-100	66	K225-30-G	154	K524-30-G*	155	KAN-COS-EC	46	KLMU100-	56	LG-37-L-NL	316
2SDSK/4110-	36	ET335	83	HE167-150	66	K225-90-G*	155	K525-20-G	154	KAN-COS1/4DIN	46	KLT-LIFT-2000	297	LG-47-L-NL	316
2SDSK/4210-	36	ET350	83	HE167-200	66	K226-20-G	154	K525-30-G	154	KAN-COSA5	46	KLT-LIFT-2300	297	LG-50-L-	115
2SDSK/5110-	36	ET375	83	HE225-100/	69	K226-40-G	154	K525-90-G	155	KAN-COSA6	46	KLT-LIFT-3000	297	LG-50-Q-	115
2SDSK/5210-	36	ET378	83	HE225-150/	69	K226-60-G	154	K526-20-G	154	KAN-COSA7	46	KLT-LIFT-3300	297	LG-50-T-	115
2SDSK/6110-	36	ET400	83	HE238-100/	69	K227-20-G	154	K526-40-G	154	KAN-COSW100-60	52	KLT-SNAP-1/3DIN-ESD/20	237	LG-50-W45-	101
2SDSK/7110-	36	ET402	83	HE238-150/	69	K227-30-G	154	K526-60-G	154	KAN-COW-EC	47	KLT-SNAP-1/3DIN/	54	LG-50-W90-	101
ATP420	171	ET450	83	HE250-100/	69	K230-G	146	K527-20-G	154	KAN-COW1/4DIN	47	KLT-SNAP-DINA5-ESD/20	237	LG-50250-	115
ATP660-ESD-20	239	ET475	83	HE250-150/	69	K230-G	146	K527-30-G	154	KAN-COW1/4DIN-ESD	235	KLT-SNAP-DINA5/	54	LG-75-L-	115
BMS35	33	ET475	214	HE525-100/	69	K230-G	157	K531-G	146	KAN-COWA5	47	KLT-SNAP-ESD/20	237	LG-75-Q-	115
BS-SCHILD-200-	328	ET500	83	HE525-150/	69	K232-30-G	154	K531-G	146	KAN-COWA6	47	KLT-SNAP/	54	LG-75-T-	115
BS-SCHILD-297-	328	ET520	83	HE538-100/	69	K233-30-G*	155	K531-G	147	KAN-COWA7	47	KLT22-75	58	LG-75-W45-	101
BSW-SCHILD-200-	328	ET550	83	HE538-150/	69	K233-60-G*	155	K531-G	157	KAN-Gripper	32	KLT26-75	58	LG-75-W90-	101
EOX-MONOMOVER	279	ET600	53	HE547-75	214	K233-90-G*	155	K532-30-G	154	KAN-GRIPPER	232	KLT36-102	58	LG-75350-	115
EOX-MSB	346	ET600	83	HE550-100/	69	K234-15-G*	155	K533-30-G*	155	KAN-LABEL1/3DIN-ESD-20	155	KLT36-78	58	LG-ANDRUCKROLLER	137
EOX-MSBL	346	ET650	53	HE550-150/	69	K234-20-G*	155	K533-60-G*	155	236	155	KLT43-102	58	LG-CLEANER/6	135
eOX-Spot-40	111	ET650	83	HEM360-100/	75	K234-30-G*	155	K533-90-G*	155	KAN-LABEL1/3DIN/	55	KN-ALU-A0	189	LG-KL-1/2A4-	128
eOX-Spot-80	111	ET670	83	HEM360-150/	75	K235-20-G	154	K534-15-G	155	KAN-LABELA5-ESD-20	236	KN-ALU-A1	189	LG-KL-1/3DIN-	128
EOX-SPOT-80-M-1	356	ET700	83	HEM360-200/	75	K235-30-G	154	K534-20-G*	155	KAN-LABELA5/	55	KN-ALU-A2	189	LG-KL-108X279-	128
EOX-SPOT-80-M-101	356	ET730	83	HEM360-300/	75	K235-90-G*	155	K534-30-G*	155	KAN-MU-A3-	223	KN-ALU-A3	189	LG-KL-216X139-	128
EOX-SPOT-80-M-17	356	ET75	83	HEM360-600/	75	K236-20-G	154	K535-20-G	154	KAN-MU-A4-	223	KN-ALU-A4	189	LG-KL-216X279-	128
EOX-SPOT-80-M-2	356	ET75-168K-	241	HEM380-100/	75	K236-40-G	154	K535-30-G	154	KAN-MU-A5-	223	KN-BK-35	164	LG-KL-216X93-	128
EOX-SPOT-80-M-3	356	ET76-70	83	HEM380-150/	75	K236-60-G	154	K535-90-G	155	KAN-MW-A1Q-	220	KN-BK-35-ESD-06	164	LG-KL-A4-	128
EOX-SPOT-80-M-4	356	ET800	83	HEM380-200/	75	K237-20-G	154	K536-20-G	154	KAN-MW-A2H-	220	KN-BK-35-ESD-06	242	LG-KL-A5-	128
EOX-SPOT-80-M-9	356	ET830	83	HEM380-300/	75	K237-30-G	154	K536-40-G	154	KAN-MW-A2Q-	220	KN-BK-A4-35	164	LG-KL-KREIS-	129
EOX-SPOT-80-MI-1	357	ET85	83	HEM380-600/	75	K242-30-G	154	K536-60-G	154	KAN-MW-A3H-	220	KN-BK-A5-35	164	LG-KL-PFEIL-	129
EOX-SPOT-80-MI-2	357	FIFO-ADAPTER	288	HES460-100/	75	K243-30-G*	155	K537-20-G	154	KAN-MW-A3Q-	220	KN-BK-A5Q-35	164	LG-PRIMER	135
EOX-SPOT-80-MI-3	357	FIFO-BP-1200	288	HES460-150/	75	K243-60-G*	155	K537-30-G	154	KAN-MW-A4H-	220	KN-BKM-35	164	LG-REMOVER/6	135
EOX-SPOT-80-MI-4	357	FIFO-BP-1800	288	HES460-200/	75	K243-90-G*	155	K542-30-G	154	KAN-MW-A4H-04/-05	146	KN-BKM-A4-35	164	LG-SCHILD-001-04	243
EOX-SPOT-80-MI-SW	357	FIFO-BP-2400	288	HES460-300/	75	K244-20-G*	155	K543-30-G	155	KAN-MW-A4H-04/-05	146	KN-BKM-A5-35	164	LG-SCHILD-600-1	334
EOX-SPOT-M-1	356	FIFO-BP-3000	288	HES460-600/	75	K244-30-G*	155	K543-60-G*	155	KAN-MW-A4Q-	220	KN-BKM-A5Q-35	164	LG-SCHILD-600-10	335
EOX-SPOT-M-101	356	FIFO-EK-1	288	HES480-100/	75	K245-20-G	154	K543-90-G*	154	KAN-MW-A5Q-	220	KN-FLAT-04	290	LG-SCHILD-600-11	334
EOX-SPOT-M-17	356	FIFO-EK-2L	288	HES480-150/	75	K245-30-G	154	K544-20-G*	155	KAN-MWEX-A2Q-	220	KN-FLAT-EK	290	LG-SCHILD-600-12	335
EOX-SPOT-M-2	356	FIFO-EK-2R	288	HES480-200/	75	K245-90-G*	155	K544-30-G*	155	KAN-MWEX-A3Q-	220	KN-FLAT-ROLLENSET	290	LG-SCHILD-600-13	335
EOX-SPOT-M-3	356	FIFO-EKV	289	HES480-300/	75	K246-20-G	154	K545-20-G	154	KAN-MWEX-A4H-	220	KNSERM115	169	LG-SCHILD-600-14	334
EOX-SPOT-M-4	356	FIFO-PAK-L	288	HES480-600/	75	K246-40-G	154	K545-30-G	154	KAN-MWEX-A4Q-	220	KNSERM116	169	LG-SCHILD-600-15	335
EOX-SPOT-M-9	356	FIFO-PAK-R	288	HW-SCHILD-300-	330	K246-60-G	154	K545-90-G*	155	KAN-MWH-A3Q-	222	KNTA-	57	LG-SCHILD-600-16	334
EOX-SPOT-MI-1	357	FIFO-PV	289	K2-BLM4	157	K247-20-G	154	K546-20-G	154	KAN-MWH-A4H-	222	KR2203-00-G	157	LG-SCHILD-600-17	334
EOX-SPOT-MI-2	357	FIFO-SCHR-K	288	K210-G	157	K247-30-G	154	K546-40-G	154	KAN-MWH-A4Q-	222	KR2203-50-G	157	LG-SCHILD-600-2	334
EOX-SPOT-MI-3	357	FIFO-SCHR-K	288	K212-30-G	154	K5-BLM6	157	K546-60-G	154	KAN-MWHEX-A3Q-	222	KRS129-G	158	LG-SCHILD-600-3	335
EOX-SPOT-MI-4	357	FIFO-SCHR-K	288	K213-30-G*	155	K511-G	157	K547-20-G	154	KAN-MWHEX-A4H-	222	KRS154-G	158	LG-SCHILD-600-4	334
EOX-SPOT-MI-SW	357	FIFO-SCHR-K	289	K213-60-G*	155	K512-30-G	154	K547-30-G	154	KAN-MWHEX-A4Q-	222	KRS179-G	158	LG-SCHILD-600-5	334
EOX-STATION	280	FIFO-SCHR-K	289	K213-90-G*	155	K513-30-G*	155	KAN-AMPEL250/	156	KAN-MWR-A3H-	221	KRS204-G	158	LG-SCHILD-600-6	334
ET100	83	FLIP-MAG-	225	K214-20-G*	155	K513-60-G*	155	KAN-AMPEL250/6	156	KAN-MWR-A3Q-	221	KS129-G	146	LG-SCHILD-600-7	334
ET105-148	83	FLIP-MAG-ESD-	225	K214-30-G*	155	K513-90-G*	155	KAN-AMPEL500/	156	KAN-MWR-A4H-	221	KS129-G	158	LG-SCHILD-600-8	334
ET105-148	214	FLIP-MAG-ESD-20	238	K215-20-G	154	K514-20-G*	155	KAN-AMPEL500/6	156	KAN-MWR-A4Q-	221	KS154-G	158	LG-SCHILD-600-9	334
ET135	83	FX-SK-	81	K215-30-G	154	K514-30-G*	155	KAN-AMPEL75/	156	KAN-MWREX-A3Q-	221	KS179-G	146	LG-SCHILD1/2-1	336
ET136	129	FX-SK-67-	81	K215-90-G*	155	K515-20-G	154	KAN-AMPEL85/	156	KAN-MWREX-A4Q-	221	KS179-G	158	LG-SCHILD1/2-10	336
ET136-HALTESTELLE	129	FX-SK-A4-	81	K216-20-G	154	K515-30-G	154	KAN-AMPELA5/	156	KAN-PS2-04	53	KS204-G	147	LG-SCHILD1/2-11	336
ET150	83	HE120-100	66	K216-40-G	154	K515-90-G	155	KAN-AMPELA6/	156	KAN-PS2-HE100	53	KS204-G	158	LG-SCHILD1/2-2	336
ET190	83	HE120-150	66	K216-60-G	154	K516-20-G	154	KAN-AMPELA7/	156	KAN-PS2-HE150	53	KST1020	156	LG-SCHILD1/2-3	336
ET200	83	HE120-75	66	K217-20-G	154	K516-40-G	154	KAN-CLIP75	51	KAN-SERM116	146	KST1220	156	LG-SCHILD1/2-4	336
ET210	83	HE127-100	66	K217-30-G	154	K516-60-G	154	KAN-CO1/3DIN	49	KAN-SERM116	146	KT3000	30	LG-SCHILD1/2-6	336
ET220	83	HE127-150	66	K220-G	157	K517-20-G	154	KAN-COM-EC	46	KAN-U-Gripper	33	KT3000	231	LG-SCHILD1/2-7	336
ET230	83	HE127-75	66	K222-30-G	154	K517-30-G	154	KAN-COM1/4DIN	46	KAN-U-GRIPPER	232	LABC1/4-2	50	LG-SCHILD1/2-8	336
ET250	83	HE138-100	66	K223-30-G*	155	K521-G	157	KAN-COMA5	46	KE210-20	156	LABCOVA5-2	50	LG-SCHILD1/2-9	336
ET275	83	HE138-150	66	K223-60-G*	155	K522-30-G	154	KAN-COMA6	46	KE210-30	156	LABCOVA6-2	50	LG-SCHILD1/4-1	337
ET300	83	HE138-75	66	K223-90-G*	155	K523-30-G*	155	KAN-COMA7	46	KE75-15	156	LABCOVA7-2	50	LG-SCHILD1/4-2	337
ET302	83	HE147-100	66	K224-15-G*	155	K523-60-G*	155	KAN-COPI/4DIN	48	KE75-20	156	LG-100-Q-	115	LG-SCHILD1/4-3	337
ET33-168K-	152	HE147-150	66	K224-20-G*	155	K523-90-G*	155	KAN-COPA5	48	KE75-30	156	LG-100-W45-	101	LG-SCHILD1/4-4	337
ET33-75K-	152	HE147-75	66	K224-30-G*	155	K524-15-G	155	KAN-COPA6	48	KL100-	55	LG-100-W90-	101	LG-SCHILD1/4-5	337
ET33-75K-	241	HE148-105	214	K225-20-G	154	K524-20-G*	155	KAN-COPA7	48	KL100-ESD-20	236	LG-100500-	115	LG-SCHILD1/4-6	337

INDEX

LG-SCHILD1/4-7	337	LGLD75-	343	LPM160-80/	73	MASI-1400-700	300	MAT-BORO-7B-CLEAN	256	MB720/	78	MR100-70/	77	OT441-US-WS	163
LG-SCHILD1/4-8	337	LGMOD-L-	127	LPS110-35/	73	MAT-ADAP-5	269	MAT-BORO-7B-ESD	245	MB725/	78	MR150-20/	77	OT442	163
LG-TS100	136	LGMOD-ND-	125	LPS110-50/	73	MAT-ADAP-ZB001	271	MAT-BORO		MB730/	78	MR150-25/	77	OT442-US-WS	163
LG-VERSIEGELUNG	135	LGMOD-SK-	125	LPS160-80/	73	MAT-ADAP-ZB002	271	-7B-ESD/COMBI	256	MB735/	78	MR150-30/	77	OT443	163
LG100-	101	LGN-90-PP	316	LPV160-80/	73	MAT-BORO-1	253	MAT-BORO		MB740/	78	MR150-35/	77	OT443-US-WS	163
LG100-	343	LGNL50	319	LTM110-35/	71	MAT-BORO-1-CLEAN	253	-7B-ESD/GUMMI	256	MB750/	78	MR150-40/	77	OT444	163
LG100-IND	102	LGNL50-	319	LTM110-50/	71	MAT-BOR		MAT-BORO-7B-ESD/NM	256	MB760/	78	MR150-50/	77	OT444-US-WS	163
LG50-	101	LGNL50-FW-L	319	LTM160-80/	71	O-1-ESD/GUMMI	253	MAT-BORO-7B-GUMMI	256	MB770/	78	MR150-60/	77	OT50	163
LG50-	343	LGNL50-FW-R	319	LTS110-35/	71	MAT-BORO-1-ESD/NM	253	MAT-BORO-7B/COMBI	256	MB775/	78	MR150-70/	77	OT50	163
LG50-ESD	101	LGNL50-PF	319	LTS110-50/	71	MAT-BORO-1-ESD/PU	253	MAT-BORO-7C	257	MB780/	78	MR60-20/	77	PAB-1200	292
LG50-ESD	244	LGNL75	319	LTS160-80/	71	MAT-BORO-1-GUMMI	253	MAT-BORO-7C-CLEAN	257	MB790/	78	MR60-25/	77	PAB-1200-V	292
LG50-IND	102	LGNL75-	319	LTV160-80/	71	MAT-BORO-1-PU	253	MAT-BORO		MB800/	78	MR60-30/	77	PAB-2400	292
LG50-SP-	131	LGNL75-FW-L	319	MA1310-	40	MAT-BORO-1/ESD	245	-7C-ESD/COMBI	257	MONO-5S-1200	276	MR60-35/	77	PAB-2400-V	292
LG6X40ND	125	LGNL75-FW-R	319	MA2000	31	MAT-BORO-1200x800	263	MAT-BORO		MONO-5S-1200-55	277	MR60-40/	77	PAB-400	292
LG75-	101	LGNL75-PF	319	MA2000	231	MAT-BORO-1200x800-1	263	-7C-ESD/GUMMI	257	MONO-5S-1800	276	MR60-50/	77	PAB-400-V	292
LG75-	343	LGOD100-	109	MA2020	32	MAT-BORO-		MAT-BORO		MONO-5S-1800-55	277	MR60-60/	77	PAB-800	292
LG75-ESD	101	LGOD50-	109	MA2020	232	1200x800-A	261	-7C-ESD/NM	257	MONO-5S-2400	276	MR60-70/	77	PAB-800-V	292
LG75-ESD	244	LGOD75-	109	MA2030	32	MAT-BORO-		MAT-BORO-7C-GUMMI	257	MONO-5S-2400-55	277	MR75-20/	77	PAB-EK1	293
LG75-IND	102	LGPF-	119	MA2030	232	1200x800-A-CLEAN	261	MAT-BORO-800-5L	258	MONO-5SVB8-1200	276	MR75-25/	77	PAB-F-1200	292
LGCP-50-L-	133	LGPF-NL	316	MA2050	33	MAT-BORO-		MAT-BORO		MONO-5SVB8-1200-55	277	MR75-30/	77	PAB-F-1200-V	292
LGCP-50-T-	133	LGR-50-P-NL	316	MA2050	233	1200x800-A-ESD/GUMMI	261	-800-5L-CLEAN	258	MONO-5SVB8-1800	276	MR75-35/	77	PAB-F-2400	292
LGCP-50250-	133	LGR-75-P-NL	316	MA2060	32	MAT-BORO-		MAT-BORO		MONO-5SVB8-1800-55	277	MR75-40/	77	PAB-F-2400-V	292
LGCP-75-L-	133	LGR-90-K-	117	MA2060	232	1200x800-A-ESD/NM	261	-800-5L-ESD/GUMMI	258	MONO-5SVB8-2400	276	MR75-50/	77	PAB-F-400	292
LGCP-75-T-	133	LGR-90-L-	117	MA2070	32	MAT-BORO-		MAT-BORO		MONO-5SVB8-2400-55	277	MR75-60/	77	PAB-F-400-V	292
LGCP-75350-	133	LGR-90-P-	117	MA2080	31	1200x800-A-ESD/PU	261	-800-5L-ESD/NM	258	MONO-BBR-200	286	MR75-70/	77	PAB-F-800	292
LGCP-KL-1/2A4-	133	LGR-90-T-	117	MA2080	231	MAT-BORO-		MAT-BORO		MONO-BP-1200	283	MU2230-	43	PAB-F-800-V	292
LGCP-KL-1/3DIN-	133	LGR-90450-	117	MA2090	31	1200x800-A-GUMMI	261	-800-5L-GUMMI	258	MONO-BP-1800	283	MU2230-ESD-	234	PAB-FH-1200	292
LGCP-KL-A4-	133	LGRCP-90-L-	133	MA2090	231	MAT-BORO-		MAT-BORO		MONO-BP-2400	283	MU2231-	43	PAB-FH-1200-V	292
LGCP-KL-A5-	133	LGRCP-90-P-	133	MA2100	31	1200x800-A-PU	261	-800D-2-CLEAN	259	MONO-BP-55-1200	284	MU2240-	43	PAB-FH-2400	292
LGCP100-	133	LGRCP-90-T-	133	MA2100	231	MAT-BORO-		MAT-BORO		MONO-BP-55-1800	284	MU2240-ESD-	234	PAB-FH-2400-V	292
LGCP50-	133	LGRCP-90450-	133	MA4110-	40	1200x800-DC	260	-800D-2-ESD/COMBI	259	MONO-BP-55-2400	284	MU2241-	43	PAB-FH-400	292
LGCP75-	133	LGRHD-90-L-	123	MA4111-	41	MAT-BORO		MAT-BORO		MONO-BP-55-EK	284	MU2250-	43	PAB-FH-400-V	292
LGFTS	105	LGRHD-90-P-	123	MA4210-	40	-1200x800-EB	267	-800D-2-ESD/GUMMI	259	MONO-BP-55-EKGS-V2	284	MU2250-ESD-	234	PAB-FH-800	292
LGFTS-KREUZUNG	105	LGRHD-90-T-	123	MA4211-	41	MAT-BORO		MAT-BORO		MONO-EK	283	MU2251-	43	PAB-FH-800-V	292
LGFTS-KURVE	105	LGRHD-90450-	123	MA5110-	40	-1200x800V	263	-800D-2-ESD/NM	259	MONO-EK-AS	285	MU2260-	43	PAB-KU-1200	295
LGFTS-WEICHE-V	105	LGSTP-	119	MA5111-	41	MAT-BORO		MAT-BORO		MONO-EK-HD-40	283	MU2260-ESD-	234	PAB-KU-2400	295
LGFTS-WEICHE-W	105	LGSV100-N	309	MA5210-	40	-1200x800V1	263	-800D-2-GUMMI	259	MONO-EK-HD-55	284	MUV230-	43	PAB-KU-400	295
LGFTS-WEICHE-Y-L	105	LGSV100-N-	319	MA6110-	40	MAT-BORO-2	254	MAT-BORO-800D-2-PU	259	MONO-EKGS-V2	283	MUV231-	43	PAB-KU-800	295
LGFTS-WEICHE-Y-R	105	LGSV100-P	307	MA7110-	40	MAT-BORO-2-CLEAN	254	MAT-BORO		MONO-HB	285	MUV240-	43	PAB-KU-EK	295
LGGRIP100-	106	LGSV100-UN	306	MASB-1000-600	300	MAT-BORO		-800D-2/COMBI	259	MONO-HB-SET	278	MUV241-	43	PAB-SERVICE-	293
LGGRIP100-	310	LGSV100-UN-	319	MASB-1000-700	300	-2-ESD/GUMMI	254	MAT-BORO-800x600	262	MONO-NA-2000-	285	MUV250-	43	PAB-ZW2	293
LGGRIP100-	343	LGSV100-UN-	319	MASB-1200-600	300	MAT-BORO-2-ESD/NM	254	MAT-BORO-800x600-1	262	MONO-RLS	286	MUV251-	43	PAB-ZW3	293
LGGRIP50-	106	LGSV50-FX	308	MASB-1200-700	300	MAT-BORO-2-ESD/PU	254	MAT-BORO-800x600V	262	MONO-SB5S	282	MUV260-	43	PAB-ZW4	293
LGGRIP50-	310	LGSV50-N	309	MASB-1400-600	300	MAT-BORO-2-ESD4	245	MAT-BORO-800x600V1	262	MONO-SB5SVB8	282	OT410	162	PE-SCHAUM	325
LGGRIP50-	343	LGSV50-N-	319	MASB-1400-700	300	MAT-BORO-2-GUMMI	254	MAT-BORO-KU-2	252	MONO-SP-1200-V	278	OT410-US-WS	162	PE-SCHAUM	327
LGGRIP75-	106	LGSV50-P	307	MASB-V-1000-600	301	MAT-BORO-2-PU	254	MAT-BORO-ZB001	264	MONO-SP-1800-V	278	OT411	162	PE-SCHAUM	329
LGGRIP75-	310	LGSV50-UN	306	MASB-V-1000-700	301	MAT-BORO-3	251	MAT-BORO-ZB002	264	MONO-SP-2400-V	278	OT411-US-WS	162	PE-SCHAUM	331
LGGRIP75-	343	LGSV50-UN-	319	MASB-V-1200-600	301	MAT-BORO-3-CLEAN	251	MAT-BORO-ZB003	264	MONO-SP-EK-V	278	OT412	162	PFH22	33
LGGW100-	343	LGSV50-UN-	319	MASB-V-1200-700	301	MAT-BORO		MAT-BORO-ZB004	264	MONO-STOP	286	OT415	162	PKR-5S	188
LGGW30-P-	59	LGSV75-FX	308	MASB-V-1400-600	301	-3-ESD/GUMMI	251	MAT-PD1	270	MONO-STOP-55	286	OT415-US-WS	162	PKR-A1-200-	177
LGGW30-P-	343	LGSV75-N	309	MASB-V-1400-700	301	MAT-BORO-3-ESD/NM	251	MAT-PD1-ESD	270	MONO-SV-100	285	OT416	162	PKR-A2-200-	177
LGGW50-	343	LGSV75-N-	319	MASI-1400-600	300	MAT-BORO-3-ESD/PU	251	MAT-PD2	270	MONO-VB-2	285	OT417	162	PKR-A3-100-	177
LGGW75-	343	LGSV75-P	307	MASI-V-1000-600	301	MAT-BORO-3-GUMMI	251	MAT-PD2-ESD	270	MONO-VB-800	285	OT417-US-WS	162	PKR-A4-01-SD	181
LGHD-50-L-	121	LGSV75-UN	306	MASI-V-1000-700	301	MAT-BORO-3-PU	251	MAT-RW-ZB001	266	MONO-VB-800-W45D	286	OT418	163	PKR-A4-100-	177
LGHD-50-T-	121	LGSV75-UN-	319	MASI-V-1200-600	301	MAT-BORO-5-CLEAN	255	MAT-RW12X8-001	266	MONO-VB-W45D	286	OT418-US-WS	163	PKR-A4-100-	282
LGHD-50250-	121	LGSV75-UN-	319	MASI-V-1200-700	301	MAT-BORO		MAT-SD	265	MR100-20/	77	OT420	162	PKR-A5-100-	177
LGHD50-	107	LGZS120-	338	MASI-V-1400-600	301	-5-ESD/GUMMI	255	MAT-STANGE	264	MR100-25/	77	OT420-US-WS	162	PKR-BST	181
LGLD50-	99	LGZS120-	338	MASI-V-1400-700	301	MAT-BORO-5-ESD/NM	255	MAT-TAXI001	268	MR100-30/	77	OT430	162	PKR-CH-100	179
LGLD50-	99	LGZS150-	338	MASI-1000-600	300	MAT-BORO-5-ESD/PU	255	MAT-TAXI002	268	MR100-35/	77	OT430-US-WS	162	PKR-CL-AP-100	178
LGLD50-	343	LGZS150-	338	MASI-1000-700	300	MAT-BORO-5-GUMMI	255	MAT-TAXI003	268	MR100-40/	77	OT440	163	PKR-CL-FS-200	184
LGLD75-	99	LPM110-35/	73	MASI-1200-600	300	MAT-BORO-5-NG	255	MB710/	78	MR100-50/	77	OT440-US-WS	163	PKR-CL-GH-100	178
LGLD75-	99	LPM110-50/	73	MASI-1200-700	300	MAT-BORO-5-PU	255	MB715/	78	MR100-60/	77	OT441	163	PKR-CL-HK-100	180

INDEX

PKR-CL-KK-100	181	SD016-	30	SL067-200	66	TKPLD600-V2-	313
PKR-CL-MAD-100	179	SD016-ESD-	230	SMB520	79	TKPLD800-	313
PKR-CL-MAD-200	184	SD018-	30	SMB525	79	TKPLD800-V2-	313
PKR-CL-OED-100	180	SD018-ESD-	230	SMB530	79	TKPUN1000-	314
PKR-CL-OED-200	185	SD019-	30	SMB535	79	TKPUN600-	314
PKR-CL-RK-100	183	SD020-	30	SMB540	79	TKPUN800-	314
PKR-CL-RK-200	184	SD020-ESD-	230	SMB550	79	VB-1000-G	157
PKR-CL-RK-35120	183	SD021-	30	SMB560	79	VB-250-G	157
PKR-CL-RKW-100	178	SD2M/1310-	40	SMB570	79	VB-350-G	157
PKR-CL-SHD-100	179	SD2M/4110-	40	SMB575	79	VB-500-G	157
PKR-CL-SHD-200	185	SD2M/4111-	41	SMB580	79	VB-700-G	157
PKR-CL-T60-100	179	SD2M/4210-	40	SMB600	79	VB-BA-MA	215
PKR-CL-VA-100	178	SD2M/4211-	41	STP420-	170	VB-HMS-01	214
PKR-CL-VB-100	183	SD2M/5110-	40	SYSB-	150	VB-HMS-04	214
PKR-CL-VS-100	180	SD2M/5111-	41	SYSB-	150	VB-HMS-05	214
PKR-CL-VS-200	185	SD2M/5210-	40	SYSB-07	146	VB-KB-A4H-88	224
PKR-CL-WH-100	180	SD2M/6110-	40	SYSB-07	146	VB-KB-A4Q-88	224
PKR-CL-WH-200	184	SD2M/7110-	40	SYSB-07	147	VB-KBM-A4H-88	224
PKR-DK	187	SD4M/4110-	40	SYSB-A4-HE-242	149	VB-KBM-A4Q-88	224
PKR-DM50-02	187	SD4M/4111-	41	SYSB-A4-HE-90	149	VB-LC-500	211
PKR-KK	187	SD4M/4210-	40	SYSB-A4-WH-1	149	VB-LC-700	211
PKR-MH	182	SD4M/4211-	41	SYSB-A4B-	148	VB-LC360-500	209
PKR-R28	186	SD4M/5110-	40	SYSB-A4B-	148	VB-LC360-700	209
PKR-RCL-100	182	SD4M/5111-	41	SYSB-A4B-WH-U	149	VB-LP	215
PKR-RCL-200	182	SD4M/5210-	40	SYSB-A4S-	148	VB-SH-MA	214
PKR-RCL90-100	182	SDSK/1310-	36	SYSB-A4S-	148	VB-SH4-MA	215
PKR-RCL90-200	182	SDSK/4110-	36	SYSB-A4S-WH-U	149	VB-ST-1000-A	207
PKR-RES-28	186	SDSK/4210-	36	SYSB-ESD-06	240	VB-ST-1500-A	207
PKR-RK-28	182	SDSK/5110-	36	SYSB-FH	151	VB-ST-1700-A	207
PKR-RV28	186	SDSK/5210-	36	SYSB-FH	241	VB-ST-2000-A	207
PKR-SHK	186	SDSK/6110-	36	SYSB-HE-169	146	VB-ST-HALT	213
PKR-SKH-30	183	SDSK/7110-	36	SYSB-HE-169	146	VB-WA-1000-THEM	199
PKR-WHB-100	183	SDVF/1310-	40	SYSB-HE-169	147	VB-WA-1000-W	205
R262/	78	SDVF/4110-	40	SYSB-HE-169	152	VB-WA-1200-MASCH	203
R512/	78	SDVF/4111-	41	SYSB-HE-169-ESD	241	VB-WA-1500-W	205
R513/	78	SDVF/4210-	40	SYSB-HE-35	146	VB-WA-1700-W	205
R514/	78	SDVF/4211-	41	SYSB-HE-35	146	VB-WA-2000-PROD	200
RBM-MA-35	225	SDVF/5110-	40	SYSB-HE-35	147	VB-WA-2000-SCRUM	201
RBM-MA-35	238	SDVF/5111-	41	SYSB-HE-35	151	VB-WA-2000-VERB	202
RT-Schild-200-	324	SDVF/5210-	40	SYSB-HE-35-ESD	241	VB-WA-2000-W	205
RT-Schild-300-	324	SDVF/6110-	40	SYSB-HE-35-SPERR	146	VB-WA-2400-INFO	198
RT-Schild-400-	324	SERM103	169	SYSB-HE-35-SPERR	146	VB-WR	214
RTf-Schild-300-	326	SERM104	169	SYSB-HE-35-SPERR	147	VB-WS4	215
RTW-Schild-200-	326	SERM105	169	SYSB-HE-35-SPERR	152	VB-ZB001	214
SA12 (10 Stück)	168	SERP113	169	SYSB-RS-120	152	VB-ZB002	215
SA32 (50 Stück)	168	SERP114	169	SYSB-WH-1	151	VST-GRIPPER	33
SA33 (100 Stück)	168	SERP115	169	SYSB-WH-1	241	VST-GRIPPER	64
SBAM103	168	SERP116	169	SYSB-WH-4	146	VST-GRIPPER	233
SBAM104	168	SL020-100	66	SYSB-WH-4	146	VST-LABEL-100	64
SBAM105	168	SL020-150	66	SYSB-WH-4	147	VST-LABEL-200	64
SBAP103	168	SL020-75	66	SYSB-WH-4	151	WDH1	30
SBAP104	168	SL027-100	66	SYSB-WH-4	241	Z1000	157
SBAP105	168	SL027-150	66	SYSB-WH-U	151	Z500	157
SD011-	30	SL027-75	66	SYSB-WH-U	241	Z750	157
SD011-ESD-	230	SL038-100	66	SZW110 (1 Stück)	168		
SD012-	30	SL038-150	66	TKP-FD	315		
SD012-ESD-	230	SL038-75	66	TKPHD1000-	315		
SD013-	30	SL047-100	66	TKPHD600-	315		
SD013-ESD-	230	SL047-150	66	TKPHD800-	315		
SD014-	30	SL047-75	66	TKPLD1000-	313		
SD015-	30	SL067-100	66	TKPLD1000-V2-	313		
SD015-ESD-	230	SL067-150	66	TKPLD600-	313		

General Terms and Conditions

Our services are aimed exclusively at tradespeople, retailers, industry and institutions.

Prices

Price details: All prices are quoted in euros. Unless otherwise agreed, invoicing shall be based on the prices valid on the day of delivery. The prices are net prices, excluding packaging and excluding VAT, from Langenfeld. Price deviations: We make an effort to provide accurate and up-to-date price information. However, price variations may occur and we reserve the right to adjust prices at our discretion and without prior notice.

Errors in prices: Despite our best efforts, errors may occur in our pricing information, whether due to technical errors, typographical errors or other unintentional causes. In the event of an obvious pricing error, we reserve the right to cancel or amend your order, to reflect the correct price. We will notify you immediately in such a case and give you the opportunity to confirm or cancel your order.

Delivery/shipping/packaging

Delivery shall be at the risk of the customer. Dispatch shall be carried out by the means we deem most suitable and in the packaging we deem most suitable. Special requests shall be charged to the purchaser.

Delivery times

Specified delivery times are non-binding. Delayed delivery does not entitle the customer to cancel the order or to assert claims for damages.

Complaints

Any obvious defects must be reported in writing immediately, at the latest within 8 days of receipt of the goods, by sending in the delivery note. In the event of justified complaints, we are only obliged, at the buyer's discretion, to either grant a price reduction, exchange the goods or take them back and refund the purchase price.

Defects in a part of the delivery cannot lead to a complaint about the entire delivery. The customer can only demand a reduction, but not cancellation or compensation.

In the case of all self-adhesive products, our technical instructions for use do not release you from the obligation to carefully test our products on original materials before they are released for use, due to the wide range of possible applications.

Return of goods

To avoid unnecessary costs, our consent must be obtained before returning goods. Without this consent, we reserve the right to refuse acceptance.

Generally excluded from return or exchange are: all customised products, printed matter, all magnetic items (e.g. magnetic signs, magnetic storage labels, magnetic foils, tapes and pockets).

Customised products/special prints

In the production of special prints, we cannot accept any responsibility for errors that the client has overlooked or is responsible for in the proof. Any correction costs incurred shall be charged to the client. In the case of printed matter and customised products, the prescribed quantity is generally supplied.

The client is obliged to recognise an excess or short delivery of the ordered quantity of 10%. The delivered quantity is invoiced. We reserve the right to deviations in raw material properties, paper quality, colouring, and other material properties within the customary limits.

Equipment/trademarks/copyrights

The modification of the design, packaging, blister packaging etc. of our goods and the use of our trademark – in whatever form – is only permitted with our express consent.

ORGATEX GmbH retains the copyright and the right of reproduction in any process and for any purpose of sketches, drafts, originals, films, packaging inserts and the like. Reprinting, imitation or duplication of ORGATEX GmbH products is not permitted without our consent. Likewise, the reprinting, reproduction, and transfer of ORGATEX GmbH catalogue content to e-commerce platforms, even in extracts, is not permitted. We reserve the right to take legal action in the event of infringement.

Printing plates, matrices, lithographs, copy templates and the like remain the property of ORGATEX GmbH, even if they are invoiced separately.

Minimum order value

Very small orders are uneconomical for both our customers and us and represent a significant cost factor. Nevertheless, we have refrained from setting a minimum order value – but must charge a shipping/packaging fee of 9.00 euros in any case.

Terms of payment

Our invoices are payable within 30 days of the invoice date without deduction. We grant a 2% discount for payment within 10 days.

The contractual partner (reseller) of ORGATEX GmbH undertakes to present ORGATEX GmbH's reservation of title to its customers who do not immediately pay the purchase price in full in cash. The delivered goods remain our property until full payment has been made. The presentation of bills of exchange does not constitute payment.

Place of jurisdiction

The place of fulfilment and jurisdiction for both contracting parties is Langenfeld.



**VISIT
OUR
ONLINE
SHOP**

orgatex.com

orgatex.com



HEADQUARTERS GERMANY
ORGATEX GmbH

Albert-Einstein-Str. 19
D-40764 Langenfeld, Germany
Tel.: +49 2173 1064-0
info@orgatex.de
www.orgatex.com

ORGATEX[®]
SIMPLIFY YOUR WORKFLOW